

Science Together

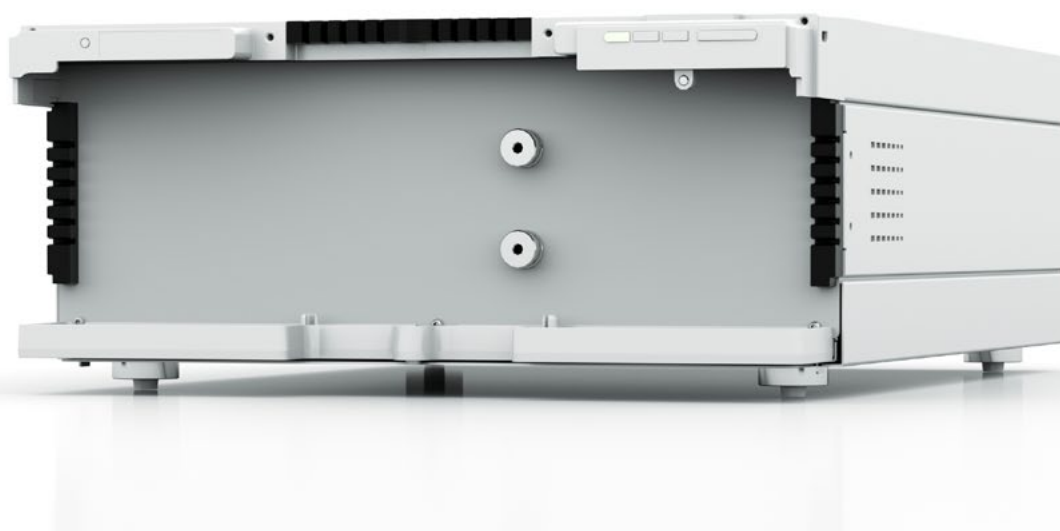

Azura

Detector RID 2.1L Instructions



Document No. V6750

HPLC



Note: For your own safety, read the instructions and observe the warnings and safety information on the device and in the instructions. Keep the instructions for future reference.



Note: In case you require this instruction in another language, please submit your request including the corresponding document number via e-mail or fax to KNAUER.

Support: Do you have questions about the installation or the operation of your instrument or software?

International Support:

Contact your local KNAUER partner for support:

www.knauer.net/en/Support/Distributors-worldwide

Support in Germany

(Austria & Switzerland on case-to-case basis):

Phone: +49 30 809727-111 (workdays 9-17h CET)

Fax : +49 30 8015010

Email: support@knauer.net

Publisher: KNAUER Wissenschaftliche Geräte GmbH

Hegauer Weg 38

14163 Berlin

Germany

Phone: +49 30 809727-0

Fax: +49 30 8015010

Internet: www.knauer.net

E-Mail: info@knauer.net

Version information: Document number: V6750

Version number: 2.2

Release date: 2020/09/09

Original edition

The information in this document is subject to change without prior notice. For the latest version of the instructions, visit our website: www.knauer.net/library.



Sustainability: The printed versions of our instructions are printed according to Blue Angel standards (www.blauer-engel.de/en/uz195).

Copyright: This document contains confidential information and may not be reproduced without written consent of KNAUER Wissenschaftliche Geräte GmbH.

© KNAUER Wissenschaftliche Geräte GmbH 2020
All rights reserved.

AZURA® is a registered trademark of
KNAUER Wissenschaftliche Geräte GmbH.

Table of contents

1. Product information	1
1.1 Intended use	1
1.2 Operating ranges	2
1.3 Views	2
1.4 Performance features	3
1.5 Functional principle	4
1.5.1 Detector design and optical path	4
1.5.2 Calculating the signal value	5
1.5.3 Flow path	5
2. Scope of delivery	7
3. Basic safety instructions	7
3.1 Target group	7
3.2 Safety equipment	7
3.3 What must the user take into account?	7
3.4 Warning notifications	9
3.5 Decontamination	9
3.5.1 Decontamination Report	9
4. Symbols and signs	9
5. Unpacking and setup	10
5.1 Operating environment	10
5.2 Unpacking the detector	11
5.3 Power supply	11
6. Initial startup	12
6.1 Connecting the leak management	12
6.2 Connecting the capillaries	13
6.2.1 AZURA® Detector RID 2.1L	13
6.2.2 AZURA® Detector RID 2.1L HighFlow	14
6.3 Integrating the detector into the system	16
6.4 Connecting the the detector to the computer via LAN	17
6.4.1 Configuring the LAN settings	17
6.4.2 Connecting the cables	18
6.4.3 Configuring the router	18
6.4.4 Integrating the LAN into the company network	19
6.4.5 Controlling several systems separately in the LAN	19
6.5 Remote control	22
6.5.1 Connector assignment	23
6.5.2 Connecting cables to the pin header	24
6.6 Integrator port	25
7. Operation	25
7.1 Meaning of the LEDs	25
7.2 Default settings	26
7.2.1 Autozero	27
7.2.2 Temperature control	27

7.2.3	Signal mode	27
7.2.4	Time constant & data rate	28
7.2.5	LED power factor	29
7.2.6	Extended Dynamic Range	29
7.2.7	Analog output scaling and offset	29
7.3	GLP	30
7.4	Switching on the detector	30
7.5	Flushing the flow cell	31
7.6	Activate standby	32
7.7	Switching off the detector	32
8.	Functionality tests	33
9.	Troubleshooting	34
9.1	Error analysis	34
9.2	LAN	34
9.3	Device problems	35
9.4	System messages	35
9.5	Proceeding with tasks after a leak	37
10.	Maintenance and care	37
10.1	User tasks and intervals	37
10.2	Check calibration/validation	38
10.3	Preparing the detector for storage or transport	38
11.	Technical data	39
11.1	Main features	39
11.2	Communication	40
11.3	General	40
12.	Chemical compatibility of wetted materials	40
12.1	General	40
12.2	Plastics	41
12.3	Non-metals	43
12.4	Metals	43
13.	Repeat orders	44
14.	Legal information	45
14.1	Transport damage	45
14.2	Warranty conditions	45
14.3	Warranty seal	45
14.4	Declaration of Conformity	46
14.5	Disposal	46
14.5.1	AVV-marking Germany	46
14.5.2	WEEE registration	46
14.5.3	Eluents and other operating materials	46
15.	HPLC glossary	46

1. Product information

The AZURA® Detector RID 2.1L / RID 2.1L HighFlow¹ is a sensitive and competitively priced differential refractometer which is suitable for detecting compounds with little or no UV activity such as alcohols, sugars, lipids or polymers in high concentrations.

AZURA® L-characteristics

The device is a member of the AZURA L product line and shares a number of common features.

- The front cover serves as a protection for the detector and its users, but can also be removed.
- The detector is a sturdy device due to its large footprint and low center of gravity.
- The leak tray on the front collects leaking fluids and protects the components from possible damage.
- The LEDs indicate the device status. This tells the user whether the detector is working properly or whether an error has occurred.
- On the rear side you will find the supply connection and further connections to control the device.

Identification

The device name is above the serial number on the front. A white sticker on the back gives information about the manufacturer (name and address), the product number and the specifications of the supply connection.



Note: At the time of delivery, the detector is filled with ethanol.

1.1 Intended use



Note: Only use the device for applications that fall within the range of the intended use. Otherwise, the protective and safety equipment of the device could fail.

Detection via refractive index is very suitable for analytical HPLC (High Performance Liquid Chromatography), GPC (Gel Permeation Chromatography) and SEC (Size Exclusion Chromatography).

RI detectors are extremely versatile, but the detection is made with lower sensitivity as with other detection methods. RI detectors are not suitable for gradient chromatography, because they react very sensitive to changes in eluent composition. In addition, RI detectors are very dependent from temperature and pressure, and unstable conditions cause base line instability. In some cases, positive and negative peaks may occur in a single analysis.

The detector is designed for research and may be not suitable for diagnostic purposes.

¹ Both variants will be referred to as "detector"

1.2 Operating ranges

The AZURA® Detektor RID 2.1L can be used in the following areas for analytical applications (with flow rates up to 10 ml/min):

- Food analysis
- Chemical analysis
- Pharmaceutical analysis
- Environmental analyses
- Biochemical analysis

The AZURA® Detektor RID 2.1L HighFlow can be used for preparative applications (with flow rates up to 100 ml/min): It is not suitable for analytical applications.

1.3 Views

Front view

- ① Label with maximum flow rate
- ② OUT port
- ③ IN port
- ④ Standby button with LED display (see 7.1 on page 25)
- ⑤ Leak tray
- ⑥ Capillary guide

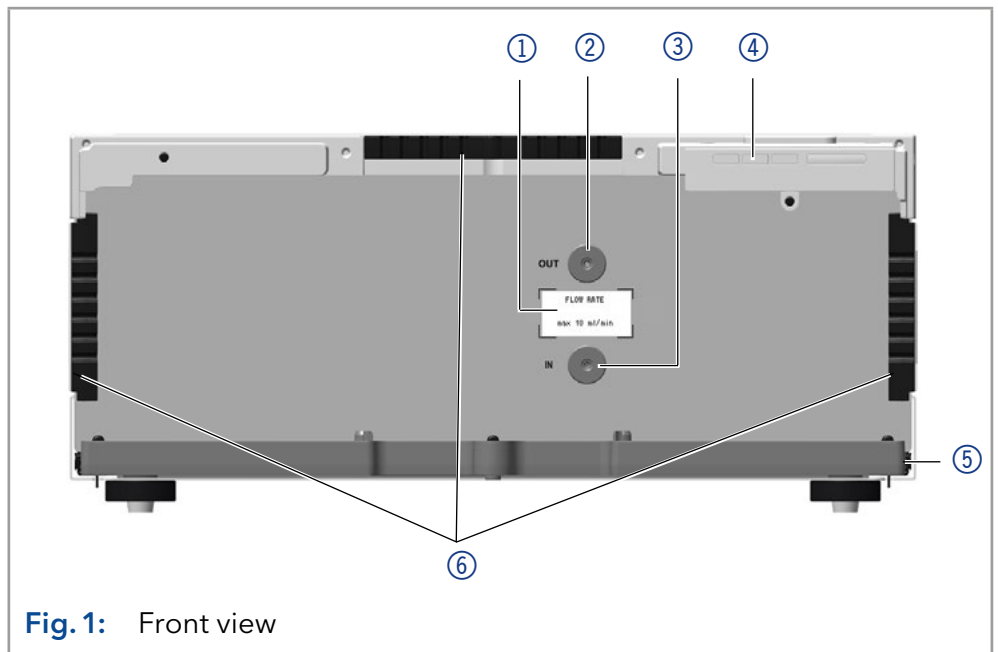

Fig. 1: Front view

Rear view

- ① Integrator port
- ② Service interface (USB)
- ③ LAN and switch connector 1
- ④ LAN and switch connector 2
- ⑤ Pin header
- ⑥ Power supply connection and power switch

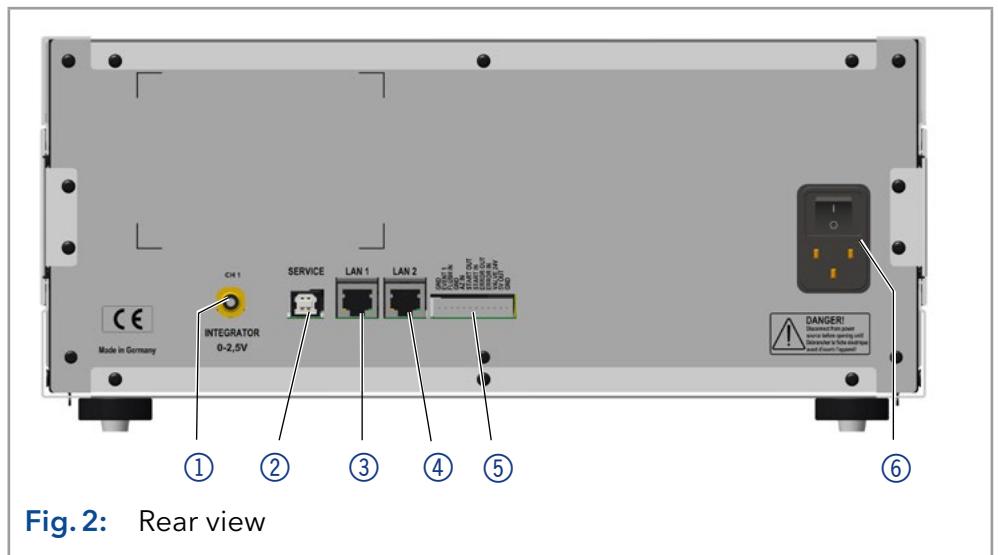

Fig. 2: Rear view

⑦ Rear label

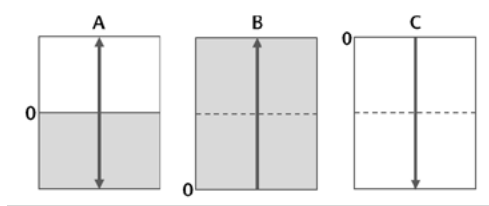

Fig.3: Label

1.4 Performance features

Optical bench The newly designed optical bench with advanced temperature control ensures high sensitivity, fast baseline stabilization, and excellent reproducibility. Furthermore, the long-life LED and highly back pressure resistant flow cell guarantee minimal maintenance.

Extended Dynamic Range If the Extended Dynamic Range option is active, it is possible to broaden the linear dynamic range.



Data rate The detector measures with a maximum data rate of 100 Hz. During the measurement, approx. 100 spectra per second are recorded.

Control The detector can be operated with one of the available chromatography data systems (OpenLAB® EZChrom Edition, ClarityChrom®, Chromeleon™, PurityChrom® and Mobile Control Chrom), as well with an optional touch display (Mobile Control), via LAN or analog input/output, by which it can be integrated in nearly every LC system.

GLP data The Mobile Control and supported software products display or read GLP data, such as the operating hours of the device or light sources. For a detailed description of viewing or reading the GLP data, see the appropriate instructions for the software products: (<https://www.knauer.net/en/Support/User-manuals/Software>).

Troubleshooting Light intensity and balance, zero glass position and LED current can be easily monitored via the Mobile Control and supported software products to ensure optimal working conditions for your analysis.

AZURA® Neo The AZURA® Neo electronic platform features:

- New microprocessor for faster device performance
- Communication interfaces: IP dual stack with switch (for connecting AZURA® devices among each other) and LAN stack function plus USB service interface (internal USB to RS-232). Both LAN ports (1 and 2) can be used as interface or as switch.
- Industrial standard 4–20 mA analog input (replacing 0–10 V input on the previous electronic platform).
- No external display support.

1.5 Functional principle

When a ray of light passes from one medium into another the light is refracted or bent depending on the light ray's speed of light and the angle of incidence. The extent to which a medium refracts light is its refractive index (RI). Snell's law of refraction expresses the relationship between the angle of incidence and the angle of refraction.

Snell's Law of refraction

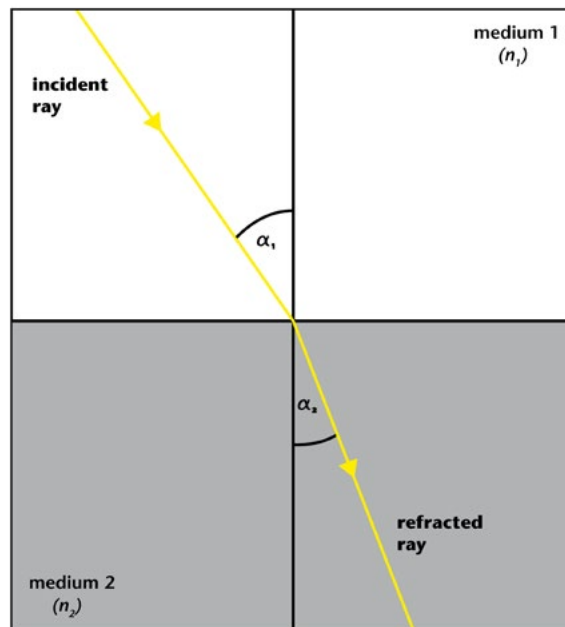

$$\frac{\sin \alpha_1}{\sin \alpha_2} = \frac{c_1}{c_2} = \frac{n_1}{n_2} = n$$

where

α_1 = angle of incidence

α_2 = angle of refraction

c_1 = speed of light in medium 1

c_2 = speed of light in medium 2

n_1 = refractive index in medium 1

n_2 = refractive index in medium 2

n = relative refractive index

The refractive index of a medium depends on the wavelength of the light and the density of the medium. Normally, in an RI detector, the wavelength is constant. The density depends on the temperature, pressure and composition of the medium.

1.5.1 Detector design and optical path

The AZURA® Detector RID 2.1L HighFlow is a differential refractive index detector of the deflection type. The detector measures the deflection of a light beam caused by the difference in refractive index between the liquids in sample and reference cell compartments of the flow cell.

A light beam emitted from the LED light source ① crosses the RID's sample and the reference cells ② twice. When both cells contain pure solvent, the system is calibrated to zero by means of a parallel zero glass plate ③ which positions the beam on the two detector diodes ④ in such a manner that the measured light intensities (I_1 and I_2) of the two diodes are virtually identical. When the sample cell contains a solution with a

different refractive index, the light beam is geometrically proportionally deflected depending on the relative change of the refractive index (according to Snell's law).

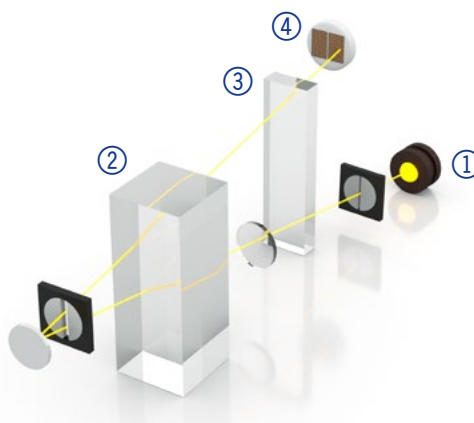

This results in a change of the light intensities I_1 and I_2 (one increases and the other decreases), proportional to concentration and refractive index of the sample solution. From these intensity changes the signal value is calculated.

1.5.2 Calculating the signal value

Signal value

$$\text{signal} = \left\{ \frac{(I_1 - I_2)}{(I_1 + I_2)} + a \right\} \times c$$

$I_1 - I_2$ = difference of intensity values
 $I_1 + I_2$ = sum of intensity values
 a = autozero constant
 c = calibration constant

The light beam reaches the two detector diodes (1 and 2) which deliver the intensity values I_1 and I_2 during measurement, depending on the light beam's deflection. The difference and sum of I_1 and I_2 are calculated continuously, and the resulting signal is given out to the device's outputs.

1.5.3 Flow path

Analysis During analysis, the solvent takes the following flow path (see Fig. 4):

1. Enters through IN port.
2. Passes through heat exchanger.
3. Flows through sample compartment of the flow cell.
4. Passes through T piece and flush valve.
5. Exits through OUT port.

Legend

- ① Solvent
- ② Heat exchanger
- ③ Sample cell
- ④ Reference cell
- ⑤ Temperature controlled compartment
- ⑥ T piece
- ⑦ Flush valve
- ⑧ Waste

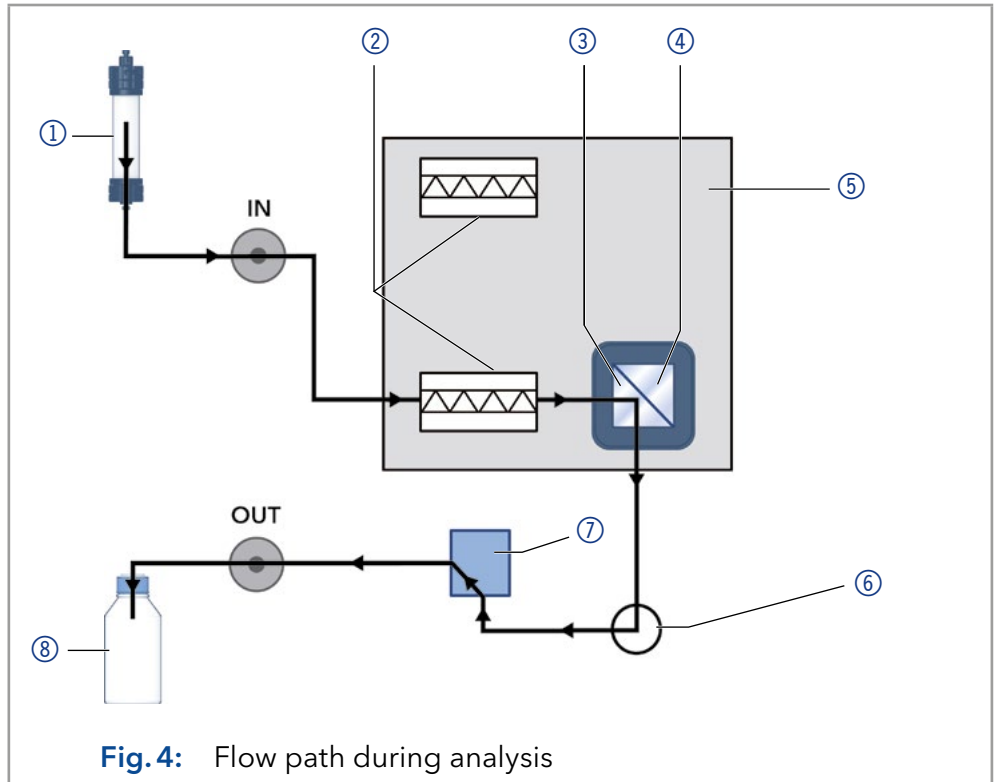

Flushing process When the flush valve is activated the solvent takes the following flow path (see Fig. 5):

1. Enters through IN port.
2. Passes through heat exchanger.
3. Flows through sample compartment of the flow cell.
4. Passes through T piece and directed to the second heat exchanger.
5. Flows through reference compartment of the flow cell.
6. Passes through flush valve.
7. Exits through OUT port.

Legend

- ① Solvent
- ② Heat exchanger
- ③ Sample cell
- ④ Reference cell
- ⑤ Temperature controlled compartment
- ⑥ T piece
- ⑦ Flush valve
- ⑧ Waste

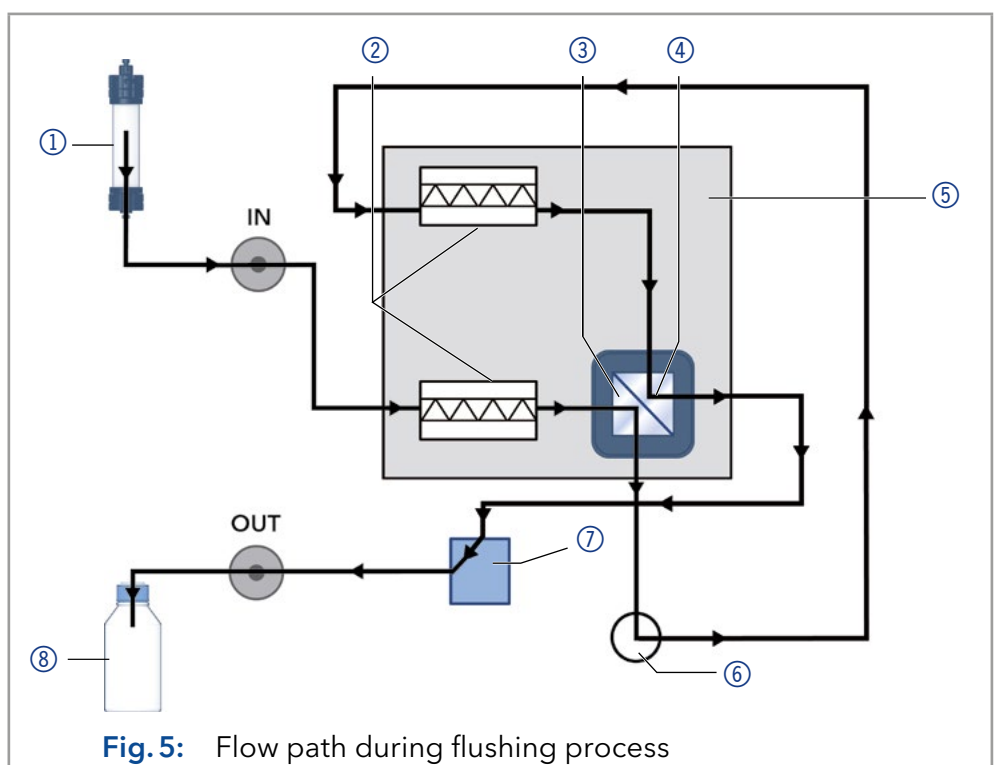

2. Scope of delivery



Note: Only use spare parts and accessories made by KNAUER or a company authorized by KNAUER.

- Power supply cable
- AZURA® Detector RID 2.1L / RID 2.1L HighFlow device
- AZURA® Detector RID 2.1L / RID 2.1L HighFlow accessory kit
- AZURA® accessory kit

Valid documents:

- AZURA® Detector RID 2.1L / RID 2.1L HighFlow Instructions (V6750)
- Installation Qualification ("IQ")
- Declaration of Conformity

3. Basic safety instructions

3.1 Target group

This document address persons who are qualified as chemical laboratory technicians or have completed comparable vocational training.

The following knowledge is required:

- Fundamental knowledge of liquid chromatography
- Knowledge regarding substances that are suitable only to a limited extent for use in liquid chromatography
- Knowledge regarding the health risks of chemicals
- Participation during an installation of a device or a training by the company KNAUER or an authorized company.

If you do not belong to this or a comparable professional group, you may not perform the work described in these instructions under any circumstances. In this case, please contact your superior.

3.2 Safety equipment

When working with the device, take measures according to lab regulations and wear protective clothing:

- Safety glasses with side protection
- Protective gloves
- Lab coat

3.3 What must the user take into account?

- All safety instructions in this document
- The environmental, installation, and connection specifications in this document
- National and international regulations pertaining to laboratory work
- Original spare parts, tools, and solvents made or recommended by KNAUER
- Good Laboratory Practice (GLP)

- Accident prevention regulations published by the accident insurance companies for laboratory work
- Filtration of substances under analysis
- Use of inline filters
- Once the capillaries have been used, never re-use them in other areas of the HPLC system.
- Only use a given PEEK fitting for one specific port and never re-use it for other ports. Always install new PEEK fittings on each separate port.
- Follow KNAUER or manufacturer's instructions on caring for the columns.

More safety-relevant information is listed below:

- flammability: Organic solvents are highly flammable. Since capillaries can detach from their screw fittings and allow solvent to escape, it is prohibited to have any open flames near the analytical system.
- solvent tray: Risk of electrical shock or short circuit if liquids get into the device's interior. For this reason, place all bottles in a solvent tray.
- solvent lines: Install capillaries and tubing in such a way that liquids cannot get into the interior in case of a leak.
- leaks: Regularly check if any system components are leaking.
- power cable: Defective power cables are not to be used to connect the device and the power supply system.
- self-ignition point: Only use eluents that have a self-ignition point higher than 150 °C under normal ambient conditions.
- power strip: If several devices are connected to one power strip, always consider the maximum power consumption of each device.
- power supply: Only connect devices to voltage sources, whose voltage equals the device's voltage.
- toxicity: Organic eluents are toxic above a certain concentration. Ensure that work areas are always well-ventilated! Wear protective gloves and safety glasses when working on the device!

Where is use of the device prohibited?

Never use the system in potentially explosive atmospheres without appropriate protective equipment. For further information, contact the Technical Support of KNAUER.

Secure decommissioning





Take the device completely out of operation by disconnecting the power plug from the power supply (wall socket or power strip).

Opening the device

The device may be opened by the KNAUER Technical Support or any company authorized by KNAUER only.

3.4 Warning notifications

Possible dangers related to the device are divided into personal and material damage in these instructions.

- 
DANGER (red) indicates a hazardous situation which, if not avoided, will result in death or serious injury.
- 
WARNING (orange) indicates a hazardous situation which, if not avoided, could result in death or serious injury.
- 
CAUTION (yellow) indicates a hazardous situation which, if not avoided, could result in minor or moderate injury.
- 
NOTICE (blue) is used to address practices not related to physical injury.

3.5 Decontamination

Contamination of devices with toxic, infectious or radioactive substances poses a hazard for all persons during operation, repair, sale, and disposal of a device.

⚠ DANGER

Life-threatening injuries

Health danger if getting in contact with toxic, infectious or radio-active substances.

- Before disposing of the device or sending it away for repair, you are required to decontaminate the device in a technically correct manner.

All contaminated devices must be properly decontaminated by a specialist company or the operating company before they can be recommissioned, repaired, sold, or disposed of. All materials or fluids used for decontamination must be collected separately and disposed of properly.



3.5.1 Decontamination Report



Devices without a completed decontamination report will not be repaired. If you would like to return a device to KNAUER, make sure to enclose a completed decontamination report with the device:

www.knauer.net/servicerequest.

4. Symbols and signs

The following symbols and signs can be found on the device:

Symbols	Meaning
	High-voltage hazard
	Electrostatic discharge hazard, damages to system, device, or components can occur.

Symbols	Meaning
 0.5 kg	Obey maximum load for leak tray during transportation, installation and operation.
	A device marked with CE fulfills the product specific requirements of European directives. This is confirmed in a Declaration of Conformity.
	Testing seals in Canada and the USA at nationally recognized testing centers (NRTL). The certified device or system has successfully passed the quality and security tests.

5. Unpacking and setup

Because of its general temperature sensitivity, the detector must always be the lowest device in a system. The RI detector must always be situated below a UV detector because it is more sensible to temperature.

The capillary kits for easy installation (available as accessory) only fit if the system is set up accordingly.



Note: At the time of delivery, the detector is filled with ethanol. Flush the system (with the flush valve open) with water for 60 minutes before starting the measurement.

5.1 Operating environment

Before you specify the location, read the technical data (see 11 on page 39). There you will find all the important information about power connection, ambient conditions and humidity.

Only if the requirements for ambient conditions of the operating environment are met, the intended use can be ensured. In order to ensure thermo stability and to prevent drift effects, note the following aspects: More effective aspects for detectors in HPLC systems are described in the according chapter (see 6.3 on page 16).



Note: The leak may malfunction if the device is placed on a tilted surface. Check the horizontal position with a spirit level.

NOTICE

Device defect

The device overheats at exposure to sunlight and insufficient air circulation. Device failures are very likely.

- Set up the device in such a way that it is protected against exposure to direct sunlight.
- Leave room for air circulation: See paragraph „space requirements“.

General requirements

- Set up the detector on an even surface.
- Protect the detector from direct sunlight.
- Set up the detector in a place protected from draft (air conditioning).
- Protect the detector from strong draft.

- Do not set up the device near to other machines that cause floor vibrations.
 - Avoid vibration.
 - Keep the detector away from high frequency sources. High-frequency sources may compromise measuring values.
 - In earthquake-endangered areas, do not stack more than 3 devices on top of each other. Otherwise there is risk of injury due to falling devices or loose parts.
- Space requirements**
- Minimum of 5 cm with a device on one side.
 - Minimum of 10 cm with devices on both sides.

5.2 Unpacking the detector

The detector is delivered in a closed package. To prevent damage, the package is the best possible protection for the protector.

- Prerequisites**
- You have checked the carton for shipping damage.
- Tools**
- Utility knife

⚠ CAUTION

Bruising danger

Damage to the device by carrying or lifting it on protruding housing parts. The device may fall and thus cause injuries.

→ Lift the device only centrally on the side of the housing.

Process

1. Set-up the package in such a way that you can read the label.
2. Cut the tape with a utility knife and open the package.
3. Lift off the foam pad. Take out the accessories kit and the manual.
4. Open the accessories kit and check the scope of delivery. In case any parts are missing, contact the Technical Support.
5. Hold the device from below, lift it out of the packaging and place it on its feet. Do not hold onto the front cover.
6. Check the device for transport damage. In case of damage, please contact the technical support.
7. Set up the device at the operation site. Remove the protective foil.

Next steps Store packaging and keep the included packing list for repeat orders.

5.3 Power supply

NOTICE

Electronic defect

Electronic hazard when using an identically constructed power adapter from another manufacturer.

→ Only use spare parts and accessories from KNAUER or a company authorized by KNAUER.



Note: Make sure that the power adapter and power cables meet the requirements (see 11.3 on page 40). Removable power cables must not be replaced by other types of cables.

- The detector is intended for use with AC power networks of 100-240 V.
- Only the supplied power cable is to be used to connect the device to the mains supply.
- Make sure that the power plug on rear of the device is always accessible, so that the device can be disconnected from the power supply.

6. Initial startup

6.1 Connecting the leak management

The leak management consists of the leak sensor and the drainage system. The drainage system ensures that escaping liquids flow into a waste bottle. If there is too much liquid, the red LED starts flashing. Both the device and the data acquisition via chromatography software are stopped.

Prerequisites ▪ Remove the front cover.

Procedure

Process

Figure

1. Carefully push the funnel ① into the center opening of the capillary guide ②.



① ②

Fig. 6: Funnel and capillary guide

2. Push the long ending of the first nozzle ④ into the hose ③.



Fig. 7: Hose and nozzle

3. Afterwards, push the nozzle onto the funnel.
4. Push the other end of the hose onto the nozzle ⑤ of the leak tray.



Fig. 8: Hose connected to device

Procedure

Process

5. Attach the waste nozzle ⑥ to the bottom unit
6. Attach the wastehose to the waste nozzle and connect it to the waste container.
7. Place the waste container below the devices.

Figure

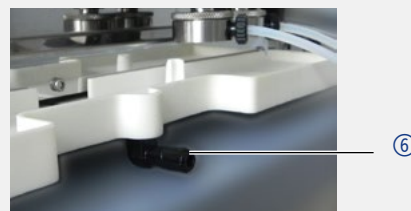

Fig. 9: Leak tray with nozzle

Next steps

- Attach the front cover.

6.2 Connecting the capillaries

NOTICE

Component defect

Damage to the flow cell due to excessive tightening. Observe the torque of the screw connection.

- Use 5 Nm for stainless steel fittings
- Use 0.5 Nm for PEEK fittings.

Important information for connecting the capillaries

Before connecting capillaries, note the following issues:

- The input capillary is connected to the IN port, the output capillary to the OUT port. If the capillaries are connected incorrectly, damages at the flow cell and a reduced detector performance may occur.
- Choose fittings which keep the dead volume at a low level, and short capillaries with a small diameter.
- The 5 bar pressure rating is only valid under flow-through conditions in the direction from the inlet to the outlet with a free drain at the outlet.
- Only install the waste tubing kit, which is part of the delivery, at the detector outlet.
- The tubing in the kit has an ID of 0.9 mm. Do not install a backpressure capillary or capillaries with a smaller inner diameter and make sure that the solvent can freely flow to the waste without any backpressure. Otherwise, damage to the detector is possible.
- If a certain back pressure at the outlet is necessary, please install a backpressure regulator, which does not build up more than 1.2 bar.
- In the case of adding an additional detector to the system, it must be connected upstream of the refractive index detector in order to avoid damage to the RID 2.1L. To optimize the detector performance the waste container should be positioned above the level of the RID 2.1L.

6.2.1 AZURA® Detector RID 2.1L

At the front side, both connections are designed for 1/16" capillaries and standardized fittings.

Following procedure can be applied for both the IN port and the OUT port.

Tools Open-end wrench

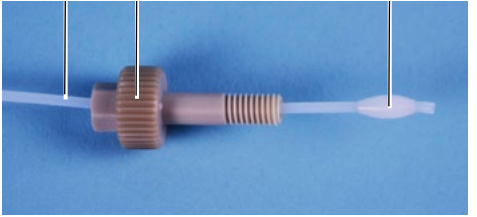
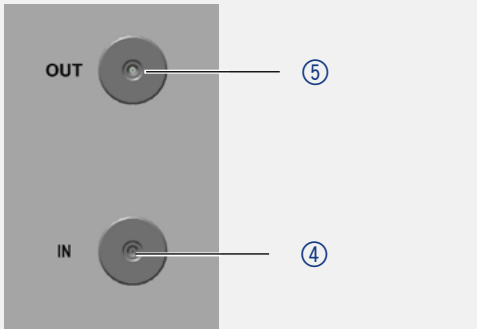
Procedure	Figure
<ol style="list-style-type: none"> 1. Push the capillary ① through the fitting ②. 2. Attach the seal ring ③. 	
<ol style="list-style-type: none"> 3. Insert the capillary as far as possible into the IN port ④ or OUT port ⑤ at the front of the device. 4. Tighten the fitting finger tight. 	

Next steps Check if all fittings are tight.

6.2.2 AZURA® Detector RID 2.1L HighFlow

At the front side, both connections are designed for 1/4" UNF flat bottom fittings.

Tools Open-end wrench

NOTICE

Component defect

Damage of the flow cell by high backpressure.

→ Install the backpressure regulator from the supplied kit.

IN port

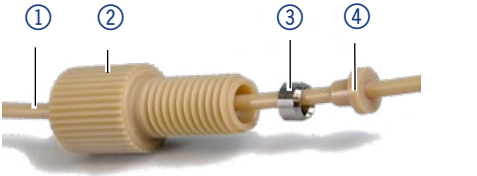
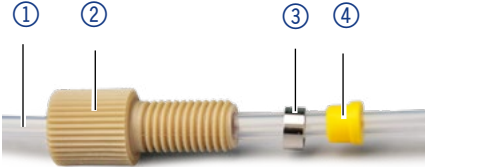
Procedure	Figure
<ol style="list-style-type: none"> 1. Push the capillary ① through the fitting ②. 2. Slide the lock ring ③ over the tubing. Note that the tapered end of the lock ring has to point to the seal ring ④. 	
<ol style="list-style-type: none"> 3. Attach the seal ring ④. 	

Procedure

4. Insert the capillary as far as possible into the IN port ⑤ at the front of the device.
5. Tighten the fitting finger tight.

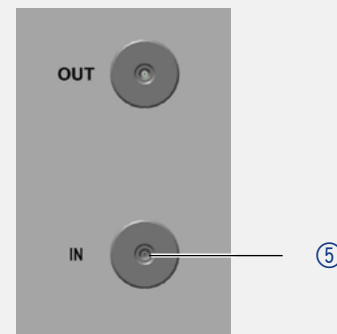
Figure**OUT port****Procedure**

1. Push the capillary ① through the fitting ②.
2. Slide the lock ring ③ over the tubing. Note that the tapered end of the lock ring (with the thin edge) has to point to the seal ring ④.
3. Attach the seal ring ④.

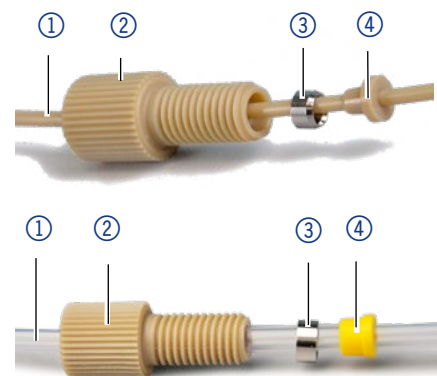

4. Insert the capillary as far as possible into the OUT port ⑤ at the front of the device.
5. Tighten the fitting finger tight.

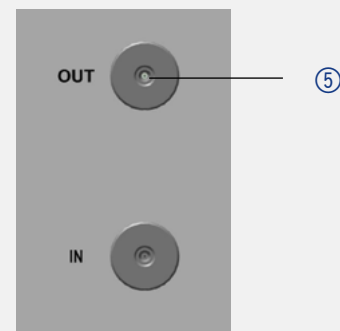

Procedure

6. Connect the capillary to the OUT port ⑥ with the T-piece ⑦ and tighten the fitting finger tight.
7. Connect the backpressure regulator ⑧ between T-piece

and capillary ⑨ which leads into a waste container. Note the arrow on the backpressure regulator which shows the flow direction.

8. Connect the capillary to the fraction collection ⑩ with the T-piece and tighten the fitting finger tight.

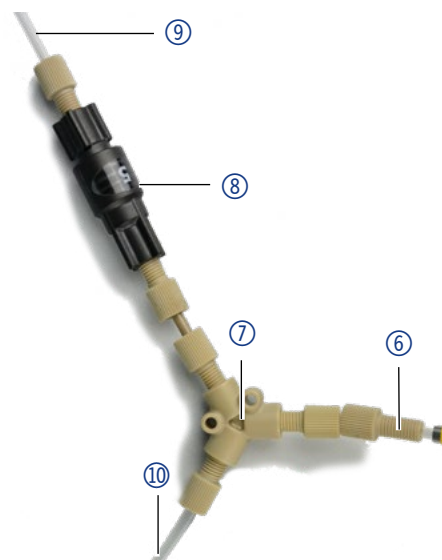
Figure

Next Steps Check if all fittings are tight.

6.3 Integrating the detector into the system

To integrate the detector into a system, note the ambient conditions found in the section Technical Data as well as the ambient conditions of other devices to be integrated into that system. The detector is integrated into the HPLC flow system by connecting the capillary to the flow cell and the HPLC system. The capillary connections in a basic HPLC system are shown in the following picture.

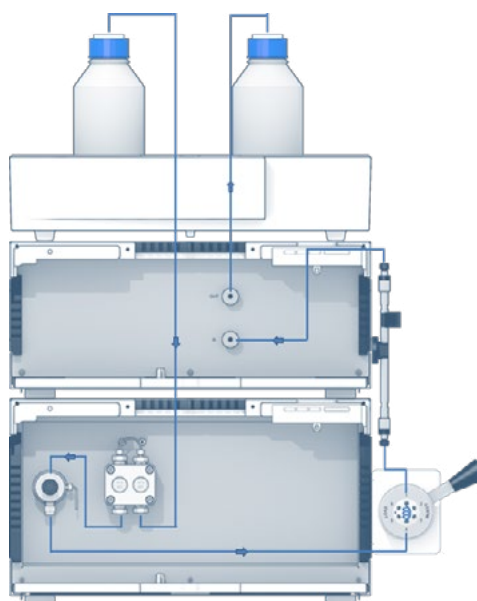

Regarding the flow path, the refractive index detector should always be the last device in a flow path of a HPLC system. The flow cell consists of glass and is very pressure sensitive. At the outlet side, back pressures may build up in the flow cell which damage the material. The pressure in the flow cell should be below 5 bar.

Prerequisites All devices are positioned accordingly.

Procedure

1. Connect the column outlet to the IN port.
2. Connect the OUT port with the waste container or fraction collector. For the AZURA® Detector RID 2.1L HighFlow, it is mandatory to install the back pressure regulator which is included in the supplied accessory kit.

Next Steps Start the devices of the system. Note the specifications of the corresponding device instructions.

6.4 Connecting the the detector to the computer via LAN

The detector can be operated with different software packages. You find more detailed information in the List of Supported Devices on the KNAUER webpage (document no. V1663):

<https://www.knauer.net/softwarecontrol>

You find a detailed description on chromatography software in a corresponding instruction.



Note: HPLC devices made by KNAUER work only with IP addresses which are assigned via IPv4. IPv6 is not supported. IPv6 is not supported.

This chapter describes how to set up a chromatography system in a local area network (LAN) and how a network administrator can integrate this LAN into your company network. The description applies to the operating system Windows® and all conventional routers.

To set up a LAN, we recommend to use a router. That means the following steps are required:

- Process**
1. On the computer, go to the control panel and check the LAN properties.
 2. Hook up the router to the devices and the computer.
 3. On the computer, configure the router to set up the network.
 4. Install the chromatography software from the data storage device.
 5. Switch on the device and run the chromatography software.

6.4.1 Configuring the LAN settings

The LAN uses only one server (which is normally the router) from that the devices automatically receive their IP address.

- Prerequisites**
- In Windows, power saving, hibernation, standby, and screen saver must be deactivated.
 - In case you use an USB-to-COM box, the option "Allow the computer to turn off ths device to save power" in the devicemanager must be deactivated for all USB hosts.
 - For all LAN devices: For all LAN devices: For the network adapter, the following option in the Device Manager must be deactivated: "Allow the computer to turn off this device to save power".

- Procedure**
1. In Windows choose Start > Control Panel > Network and Sharing Center .
 2. Double-click on LAN Connection.
 3. Click on the button Properties.

4. Select Internet Protocol version 4 (TCP/IPv4).
5. Click on the button Properties.
6. Check the settings in the tab General . The correct settings for the DHCP client are:a) Obtain an IP address automatically b) Obtain DNS server address automatically
7. Click on the button OK.

6.4.2 Connecting the cables

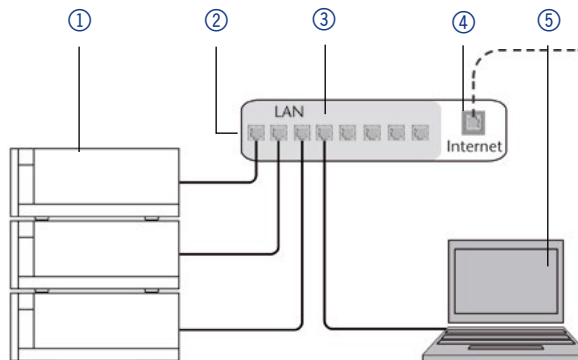

The router ③ has several LAN ports ② and one WAN-/Internetport ④ , that can be used to integrate the LAN into a wide area network (WAN), e.g. a company network or the Internet. In contrast, the LAN ports serve to set up a network from devices ① and a computer ⑤ . To avoid interference, we recommend operating the chromatography system separately from the company network.

You will find patch cables for each device and the router in the accessories kit. To connect the router to a WAN, an additional patch cable is required, which is not supplied within the scope of delivery.

- Prerequisites**
- The computer has been switched off.
 - There is a patch cable for each device and the computer.
- Procedure**
1. Use the patch cable to connect the router and the computer. Repeat this step to connect all devices.
 2. Use the power supply to connect the router to the mains power system.

6.4.3 Configuring the router

The router is preset at the factory. Information about IP address, user name and password is mentioned in the instructions of the router:

<https://goo.gl/ahGhmG>.

- Procedure**
1. To open the router configuration, start your Internet browser and enter the IP address (not for all routers).
 2. Enter user name and password.
 3. Configure the router as DHCP server.
 4. In the router configuration, check the IP address range and make changes if necessary.



Note: If the IP address range should have been changed, make sure to note this information on the router.

Result As soon as the router has assigned a n IP address to each device, the chromatography software takes over the control of the chromatography system.

6.4.4 Integrating the LAN into the company network

A network administrator can integrate the LAN into your company network. In this case you use the WAN port of the router.

Prerequisites An additional patch cable is present.

- Procedure**
1. Check that the IP address range of the router and of the company network do not overlap.
 2. In case of an overlap, change the IP address range of the router.
 3. Use the patch cable to connect the router WAN port to the company network.
 4. Restart all devices, including the computer.

6.4.5 Controlling several systems separately in the LAN

Devices connected to a LAN communicate through ports, which are part of the network address. If more than one chromatography systems are connected to the same LAN and you plan on controlling them separately, you can use different ports to avoid interference. Therefore, the port number for each device must be changed and this same number must be entered into the device configuration of the chromatography software. We recommend to use the same port number for all devices in the same system.



Note: The default port is set to 10001. You must use the same numbers in the device configuration of the chromatography software as in the device, otherwise the connection fails.

- Procedure**
1. Find out port number and change it on the device.
 2. Enter the port number in the chromatography software.

Result The connection is established.



Note: Set a fixed IP address.



Note: Check the IT safety standards for your lab before changing the LAN settings.



Two options are given to set the device IP address to fixed (static) or dynamic (DHCP) via software: Mobile Control or Firmware Wizard. Mobile Control oder Firmware Wizard.

Mobile Control: Setting a static IP address



Note: The device is default set to a dynamic IP address (DHCP). To ensure a consistent LAN connection between the chromatography software and the device, we recommend converting the device to a fixed IP address for certain applications. You find further information on LAN settings in the chapter "Device Settings" of the Mobile Control Software Instructions.

- Prerequisites**
- The device has been switched on.
 - Mobile Control has been installed and started.
 - The connection between the Mobile Control and the device has been established.

- Procedure**
1. In Mobile Control, choose  <Settings>.
 2. On the <General> tab, choose the device name.
 3. Under <Network Settings>, choose the setting <Static> .

4. Enter the IP address into the text box <IP Address> ②.
5. If necessary, change the subnet mask and the gateway ③.
6. Click **Apply** in the top right corner.
7. Restart the device.

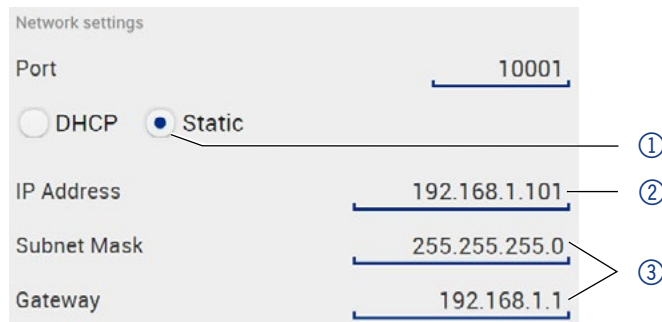

Result The device is now accessible via the static IP address.

Mobile Control: Setting IP address to DHCP via device name

- Prerequisites**
- The device has been switched on.
 - Mobile Control has been installed and started.
 - The connection between the Mobile Control and the device has been established.

- Procedure**
1. In Mobile Control, choose  <Settings>.
 2. On the <General> tab, choose the device name.
 3. In <Network Settings>, choose the setting <DHCP> ①.
 4. Click **Apply** in the top right corner.
 5. Restart the device (recommended).

Result The device is now accessible via the dynamic IP address.

Mobile Control: Setting IP address to DHCP via device serial number

- Prerequisites**
- The device has been switched on.
 - Mobile Control has been installed and started.
 - The connection between the Mobile Control and the device has been established.

- Procedure**
1. In Mobile Control, choose  <Settings>.
 2. In <Network Settings>, click <Reset>. The windows <Reset communication settings> opens.
 3. Enter the serial number of the device into the text field.
 4. Click <OK>. The device is now reset to default setting.
 5. Restart the device (recommended).

Result The device is now accessible via the dynamic IP address.

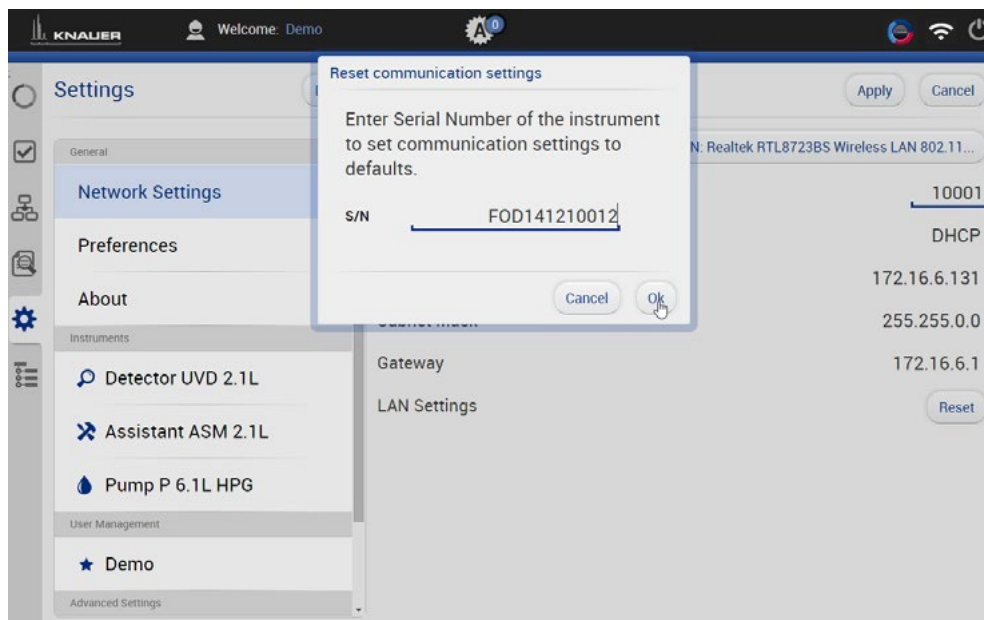

Firmware Wizard: Setting static IP address



Note: You find further information on LAN settings in the chapter “Firmware Wizard” of the Mobile Control instructions.

Prerequisites

- The device has been switched on.
- Firmware Wizard has been installed and started.
- The connection between Firmware Wizard and the device has been established.

Procedure

1. In Firmware Wizard, click <Reset LAN Settings...>.
2. The window <Device connection settings> opens. Enter serial number of the device into the text field <Target device serial number> ①.
3. Select option <Use the following IP address> ②.
4. Enter the IP address into the text field <IP address> ③.
5. Optionally, adjust subnet mask and gateway ④.
6. Click <Reset Conn. Settings> ⑤ to accept changes.
7. Restart the device (recommended).

Result

The device is now accessible via the static IP address.

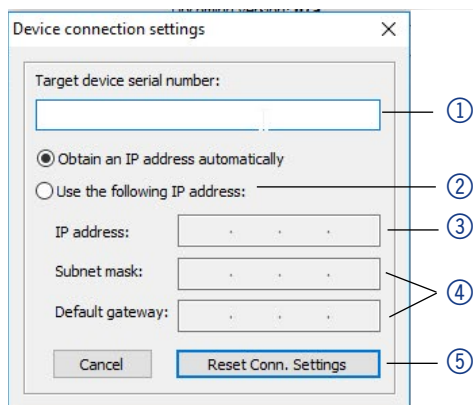

Firmware Wizard: Setting dynamic IP address

Prerequisites

- The device has been switched on.
- Firmware Wizard has been installed and started.

- The connection between Firmware Wizard and the device has been established.

- Procedure**
1. In Firmware Wizard, click <Reset LAN Settings...>.
 2. The window <Device connection settings> opens. Enter serial number of the device into the text field <Target device serial number> ①.
 3. Choose option <Obtain an IP address automatically> ②.
 4. Click <Reset Conn. Settings> ⑤ to accept changes.
 5. Restart the device (recommended).

Result The device is now accessible via the dynamic IP address.

Setting a static IP address via APIPA

To set an IP address for a detector, it must be connected to a LAN network. Both LAN ports of the detector and be connected as needed with a PC and/or with any other device. Note that the other device can again be connected with a third device and so on, so you may add several devices in a row.

Via Mobile Control, you can set the IP address either manually or via DHCP. In addition, all devices with AZURA® Neo can be set via "routerless" APIPA configuration.

To set an IP address via APIPA configuration, the PC and the LAN control must be set to DHCP mode. If no DHCP server can be detected, the device switches into APIPA configuration and receives an IP address automatically. This process may take several minutes.

6.5 Remote control

On the rear of the valve drive are sockets on a terminal strip. Signals can be send and received by other devices via those sockets. The signals are for example start signals of a injection valve or autosampler which is connected to the START connector. All voltages between GROUND and the corresponding input or output must be connected.

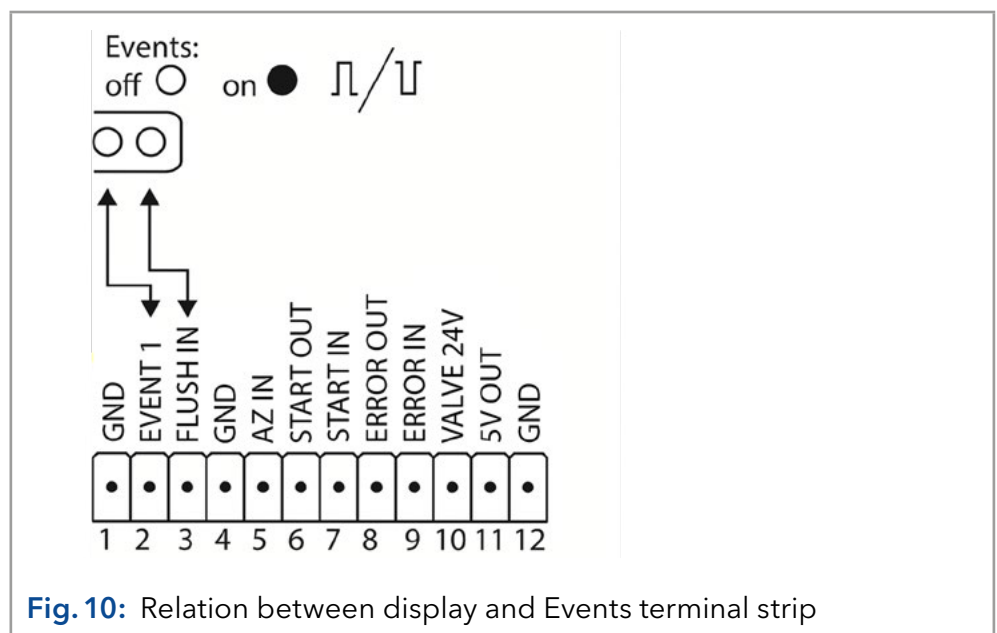

6.5.1 Connector assignment

Plug	Function
GND	Grounding of all inputs and outputs. Reference point of the voltage at the signal inputs.
EVENT 1	TTL output (default setting)/ OC with external pull-up to 24 V (25 mA) Levels: <ul style="list-style-type: none"> ▪ passive 5 V ▪ active 0 V
FLUSH IN	TTL-compatible input <ul style="list-style-type: none"> ▪ Low-active Secure switching threshold at least 10 mA Activates or deactivates the flush valve.
GND	Grounding of all inputs and outputs. Reference point of the voltage at the signal inputs.
AUTOZERO IN (AZ IN)	TTL-compatible input <ul style="list-style-type: none"> ▪ Low-active Secure switching threshold at least 10 mA A signal (short-circuit to ground) sets the measuring signal to zero. The measuring will be started again if the signal is switched off.
START OUT	TTL output (default setting)/ OC with external pull-up to 24 V (25 mA) Levels: <ul style="list-style-type: none"> ▪ passive 5 V ▪ active 0 V
START IN	TTL-compatible input <ul style="list-style-type: none"> ▪ Low-active Secure switching threshold at least 10 mA After receiving a signal (short-circuit to ground) from an external device, the detector starts. If controlled with software, an electronic trigger is send through the LAN.
ERROR OUT	TTL output (default setting)/ OC with external pull-up to 24 V (25 mA) Levels: <ul style="list-style-type: none"> ▪ passive 5 V ▪ active 0 V Output remains active until the cause of the error has been eliminated.

Plug	Function
ERROR IN	TTL-compatible input <ul style="list-style-type: none"> ▪ Low-active Secure switching threshold at least 10 mA After receiving a signal (short-circuit to GND) from an external device, an error message appears, and the detector stops.
VALVE 24 V	Event-controlled switching of 24 V against GND.
5 V OUT	Provides a voltage of 5 V with respect to GND. This makes it possible to supply a load that is switched by an EVENT. Protection: 5 V-50 mA
GND	Grounding of all inputs and outputs. Reference point of the voltage at the signal inputs.

6.5.2 Connecting cables to the pin header

To control one device through another, the pin header is used. To use remote control, you have to connect cables to the pin header. The single ports are used to exchange control signals.

- Prerequisites**
- The device is switched off.
 - The power plug is disconnected from the device.
- Tools**
- Operating tool

NOTICE

Electronic defect

Connecting cables to the multi-pin connector of a switched on device causes a short circuit.

- Turn off the device before connecting cables.
- Pull the power plug.

NOTICE

Electronic defect

Electrostatic discharge can destroy the electronics.

- Wear a protective bracelet against electrostatic discharge and ground.

- Process**
1. Insert the operating tool ③ in an upper small opening at the front of the pin header ①.
 2. Insert the cable into the opening ② underneath the inserted operating tool.
 3. Pull out the operating tool.

- Next Steps**
- Check whether the cables are tightly attached. Press the pin header onto the connector. Finish the installation. Bring the device into operation.

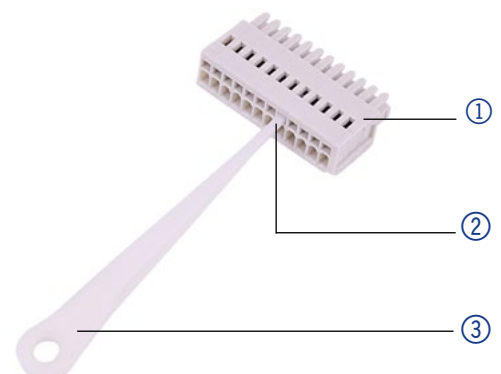

6.6 Integrator port

The integrator output supplies the current signal value as an analog voltage (0–2.5 V). Via software or Mobile Control, the signal can be scaled to 0.01 / 0.05 / 0.1 / 0.5 / 1 / 2 / 5 μ RfU/mV (see 7.2.7 on page 29). The integrator output is connected to other instruments with the analog connection cable (Cinch-Cinch, supplied with delivery) or other special connection cables (not supplied with delivery).



Note: The multiple connection to ground (simultaneous grounding via GROUND and integrator port) must be avoided. It could induce noise loops that may lead to disturbed measurement results.

Connection specification

For details on the integrator connector, see the list below:

- non-bipolar
- 1 channel
- 0–2.5 V
- DAC 20 bit
- scalable
- Adjustable to offset

7. Operation

The detector can be operated in two ways:

- Control with chromatography software
- Operating with Mobile Control



Note: It is not possible to use two control methods simultaneously. If the detector is connected to the software, it cannot be controlled via Mobile Control. The device status can be operated in two ways.

Chromatography software

To control the device with chromatography software, you have to establish a connection between the LAN port and a computer (see 6.4 on page 17). You find a detailed description on chromatography software in a corresponding instruction.

Mobile Control

The Mobile Control runs on a tablet. You find a detailed description on Mobile Control software in a corresponding instruction.

7.1 Meaning of the LEDs

There are three LEDs^① and a standby switch^② on the front of the device. The figure shows the LED panel when the device is switched off.

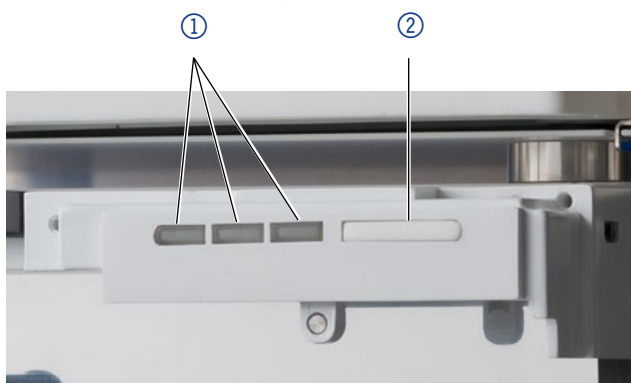

The LEDs can have different colors depending on the operating conditions.

	Color	Operating condition	Operation
Left LED	flashes red	Error message	Check the system. Shortly press the switch to deactivate the error message.
	red	Serious error	Restart the device. If the operating condition does not change, call the technical support.
	green	Program or sequence is running / has been loaded.	
Center LED	does not light	Not ready for operation	Switch on the device.
	flashes green	equilibrated	Wait until the device is ready.
	green	Ready for operation	
Right LED (Operational status)	green	Switched on	
	blue	standby	Exit with the standby switch.

Standby To start the standby, keep the switch pressed for 5 seconds.



Note: Malfunctioning system after repeated standby possible. After repeatedly using the standby, switch off the power switch and back on again, to reset the data storage.

7.2 Default settings

Using the Mobile Control, you can reset the detector to its default settings.

Parameter	Setting
Network settings	LAN DHCP port 10001
Unit	μRIU
Date/time	Current date/time
Data rate	1 Hz
Signal	direct
Time constant	2 s
LED power factor	1
Temperature	<ul style="list-style-type: none"> ■ 35 °C for RID 2.1L ■ off for RID 2.1L HighFlow

Parameter	Setting
Analog output scale	<ul style="list-style-type: none"> ■ 0.5 μRIU/mV for RID 2.1L ■ 5 μRIU/mV for RID 2.1L HighFlow
Analog output offset	100 mV
Analog output data rate	20 Hz
Analog output time constant	0.05 s
Leak sensor	ON, sensitivity = low
Extended measuring range	OFF
Flushing	OFF
Event impulse length	1000 ms
Autozero mode	OFF

7.2.1 Autozero

The autozero command leads to the zeroing of the detector signal. This command can be carried out via software or via analog command.

This is a two leveled function:

- Level one is an electronic or digital zeroing of the signal.
- Level two is an automatic zero glass adjustment. Level two is carried out automatically when the baseline drift exceeds a permitted threshold.

The autozero function generates a numeric offset value "a", employed in the calculation of the detector signal (see 1.5.2 on page 5).

By default, an autozero command is automatically carried out at the start of a run.

7.2.2 Temperature control

It is possible to select the temperature of the optical unit in the range 30-55 °C in 1 °C steps via software. It is recommended to set the temperature 5-10 °C above the ambient conditions, in order to improve and ensure baseline stability.

The default values are listed in a separate section (see 7.2 on page 26).



Note: For the AZURA® Detector RID 2.1L HighFlow, the temperature control is only effective up to a flow rate of 50 ml/min.

7.2.3 Signal mode

According to the relative refractive indexes of eluent and analyte, it is possible to obtain positive or negative peaks in your chromatogram (also in one run). Positive peaks result when the analyte has a greater refractive index than the eluent. Negative peaks result when analytes have a lower refractive index than the eluent. You can convert the signal of your peaks (direct or inverted) in your chromatogram via the signal mode option in your software.

The default values are listed in a separate section (see 7.2 on page 26).

7.2.4 Time constant & data rate

Response time The time constant influences the response time of the detector. The response time determines how quickly the detector responds to a change in signal. A good thumb rule for selection of the time constant is that it should be no larger than the baseline peak width of the first peak of interest (in seconds). Increasing the time constant allows more averaging of the signal (also known as digital filtering) and results in less baseline noise. However, increasing the time constant too much may result in broad peaks, reduced peak heights and asymmetric peak shapes. Therefore, a compromise has to be found.

Time constant Using the time constant a signal smoothing can be achieved. The larger this value is set, the more the signal will be smoothed. In general, the best time constant is the reciprocal of the data rate (see table below). If increased sensitivity is desired, or if the baseline noise is interfering with integration, the time constant should be increased. If resolution is compromised, it should be decreased.

It is recommended to set the time constant and data rate in relation to peak width.

Peak width [min]	Time constant [s]	Data rate [Hz]
< 0.003	0.01	100
> 0.007	0.02	50
> 0.017	0.05	20
> 0.033	0.1	10
>0.067	0.2	5
>0.167	0.5	2
> 0.333	1	1

Data rate The data rate (or sampling rate) is the number of data points per second (Hz) at which the detector transmits data to the computer. The maximum data rate (digital signal) is 100 Hz. Lower data rates store average data points. A 50 Hz data rate averages 2 points. A 10 Hz data rate averages 10 points. The analog data rate is fixed at 20 Hz.

The default values are listed in a separate section (see 7.2 on page 26).

Optimizing the data rate The optimal data rate depends on your application. Too few points across a peak (short data rate) decrease detail and compromise reproducibility. Too many points (high data rate) introduce noise into the system and the resulting files can become very large. Some general considerations are listed below:

- Each peak should be defined by 20–30 data points. For chromatograms with co-eluting peaks or low signal-to-noise ratios, 40–50 data points per peak are recommended.
- If all peaks are relatively wide, select a slower data rate.
- If any peaks of interest are shown less than a few seconds, select a faster data rate.
- If the data rate is too slow, the start and end points of the peaks are not accurately determined. If the data rate is too fast, data files may occupy excessive disk space and post-run analyses may require more processing time.

7.2.5 LED power factor

The LED power factor can be adjusted in order to regulate detector sensitivity. Light source durability is also affected by changes to this parameter. By increasing or decreasing this factor, the total linear range of the device is decreased. This setting can be adjusted in your software under Advanced Settings.

The default values are listed in a separate section (see 7.2 on page 26).

- Sensitivity** After changing the LED power factor, the electric current to the light source is altered and consequently the total sum of counts for both diodes is adjusted. By increasing the LED power factor (e.g. from 1 to 1.8), it is possible to increase sensitivity due to decreased signal noise. The upper limit is a total sum of 2 million counts. In the same way, it is possible to decrease the sensitivity by decreasing the LED power factor (e.g. from 1 to 0.5).
- LED durability** By decreasing the LED power factor, the lifetime of the LED light source can be increased.

7.2.6 Extended Dynamic Range

The option Extended Dynamic Range enables the extension of the dynamic measuring range to +100 % (-1000 μ RIU offset for AZURA® Detector RID 2.1L and -2500 μ RIU offset for AZURA® Detector RID 2.1L HighFlow) or -100 % (+1000 μ RIU offset for AZURA® Detector RID 2.1L and +2500 μ RIU offset for AZURA® Detector RID 2.1L HighFlow).

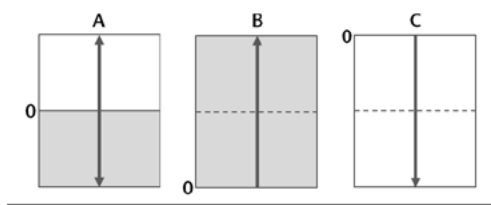

If the Extended Dynamic Range is deactivated, the positive and negative signals are detected up to +1000 μ RIU for AZURA® Detector RID 2.1L or up to +2500 μ RIU for AZURA® Detector RID 2.1L HighFlow (A).

If the positive Extended Measuring Range is activated (+100 %), the zero position is offset to -1000 μ RIU for AZURA® Detector RID 2.1L or up to -2500 μ RIU for AZURA® Detector RID 2.1L HighFlow, and the measuring range for positive signals is set to +2000 μ RIU for AZURA® Detector RID 2.1L or to +5000 μ RIU for AZURA® Detector RID 2.1L HighFlow (B).

Switching to negative range has the same effect in inverse direction (C). When this option is active, the LED power factor is set to and blocked at 1. In addition, the automatic zero glass adjustment is inactive. The Extended Dynamic Range option can be activated in the software Clarity-Chrom®, OpenLab®, and Mobile Control under Advanced Settings.

The default values are listed in a separate section (see 7.2 on page 26).

7.2.7 Analog output scaling and offset

The software enables to select analog output scaling and offset factors. Scaling factors 0.01 / 0.05 / 0.1 / 0.5 / 1 / 2 / 5 μ RIU/mV are selectable.

By reducing the scaling factor, the output signal range is reduced and the sensitivity is also reduced.

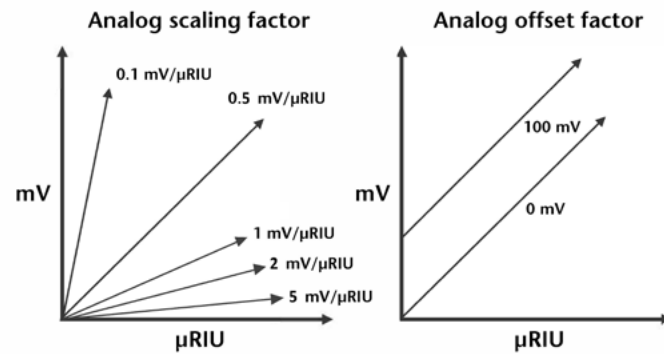

Further information on the analog output (see “Connector assignment” on page 20). The default values are listed in a separate section (see 7.2 on page 26).

7.3 GLP

The following GLP data of the detector can be found in the software.

	GLP data	Unit	Explanation
Device information	Serial number		FRAYYWWXXXXX (for devices built until mid of August 2020) FRBYYWWXXXXX (for devices built after mid of August 2020)
	Firmware version		Current firmware version of device
	Operating time	h	Operating hours after production
	Date of installation		Date of manufacture
	Last maintenance		
Light source	Operating time	h	Running hours after light source installation
	Date of installation		
	Light source number		Indicates how often the light source has been changed since manufacture.
Validation data	Last measured span	μRIU	
	Last measured span date		
Leak sensor	Serial number		Serial number leak sensor
	Firmware version		Current firmware version of leak sensor

7.4 Switching on the detector

The recommended warm-up time for the detector is 60 minutes. This recommendation is applicable after turning the detector on as well as after powering up from standby.

Prerequisites ■ The rear side must be accessible.

- Detector has been switched off.

⚠ WARNING

Burns

An overconcentration of organic solvents may lead to explosions.

→ Check the tightness of all fittings before using organic solvents.

NOTICE

Device defect

Changes of the environmental temperature cause condensation inside the device.

→ Allow device to acclimate for 3 h before connecting to power supply and taking into operation.

NOTICE

Device defect

Intruding liquids can cause damage to the device.

→ Place solvent bottles next to the device or in a solvent tray.

→ Moisten the cleaning cloth only slightly.



Note: State of safe operation is achieved even after the power connection has been interrupted because of power cut or emergency shutdown.

Procedure

1. Plug in the power supply cable ② into the socket.
2. Push the main switch ① to ON.

Figure

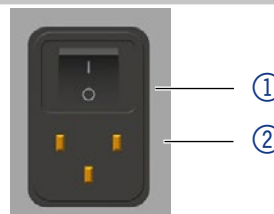

Result The right and middle LED light up green.

Next Steps Flush the flow cell.

7.5 Flushing the flow cell

Flush the system (with the flush valve open) with water for 60 minutes before starting the device test.

The flush mode activates the magnetic valve to flush the reference cell with eluent. The flow path with active flush mode is described in a separate section (see 1.5.3 on page 5).

The flush valve can be activated or deactivated directly via software; alternatively a flush mode can be configured in the software, so that the flush valve is activated and after a specific time span (30 s, 60 s, 120 s, 400 s) will be deactivated automatically. The flush mode can be cancelled any time with the OFF command. If the flush valve is active, the left LED blinks green.

The default values are listed in a separate section (see 7.2 on page 26).

Prerequisites The detector is supplied with eluent.
The detector has been switched on.

Tools Software or Mobile Control



The flush mode starts via software of Mobile Control. Flush with the eluent which you plan to use for the next measuring. If you change the eluent, make sure that the used eluent is mixable with the one used previously. Otherwise flush the flow cell with a solvent which is mixable with both eluents.

Procedure

1. Start the flush mode.
2. Check if the LED blinks green.
3. After a period of about 30 seconds, stop the flush mode.
4. Wait for the end of program.

Result The detector is now ready to operate.

Next Steps Start the measuring.

7.6 Activate standby

Prerequisites The flow is turned off.



Note: Malfunctioning system after repeated standby possible. After repeatedly using the standby, switch off the power switch and back on again, to reset the data storage.

Procedure

1. Press the standby switch ② for 5 seconds.
2. Wait if the LED ① shows a blue light.

Figure

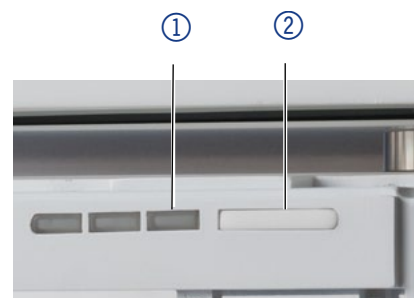

Result If you were successful, the right LED lights up blue.

Next Steps To end standby, press the switch again.

7.7 Switching off the detector

The detector is designed for the use of different solvents. In case the detector has not been used for several weeks, solvent residues may cause damage. If you plan to take the detector out of operation for a longer period of time, fill the capillary with alcohol (e.g. isopropanol) before switching it off.

Prerequisites

- The back must be accessible.
- Detector has been switched on.

- The flow cell has been flushed (see 7.5 on page 31).

Procedure**Figure**

1. Turn the main switch ① to OFF.

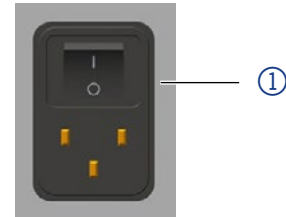
**Next Steps**

Either restart the detector soon or, you prepare it for storage (see 10.3 on page 38).

8. Functionality tests



Note: Standard processes regarding IQ and OQ in single devices may be handled differently in individual cases.

Installation Qualification (IQ)

The customer may request the Installation Qualification, which is free of charge. In case of a request, the Technical Support of KNAUER or from a provider authorized by KNAUER performs this functionality test during the installation.

The Installation Qualification is a standardized document that includes the following:

- confirmation of flawless condition at delivery
- check if the delivery is complete
- certification on the functionality of the device

Operation Qualification (OQ)

The Operation Qualification includes an extensive functionality test according to KNAUER standard OQ documents. The Operation Qualification is a standardized document and free of charge. It is not part of the delivery. Please contact the Technical Support in case of request.

The Operation Qualification includes the following:

- definition of customer requirements and acceptance terms
- documentation on device specifications
- device functionality check at installation site

Test Intervals

To make sure that the device operates within the specified range, you should test the device regularly. The test intervals depend on the usage of the device.

Execution

The test can be carried out either by the Technical Support of KNAUER or from a provider authorized by KNAUER (for a fee).



Note: Flush the system (with the flush valve open) with water for 60 minutes before starting the device test.

9. Troubleshooting

First measures:

- Check all cables.
- Check all fittings.
- Check if air has gotten into the supply lines.
- Check the detector for leaks.

9.1 Error analysis

In your software, a number of diagnostic parameters are displayed for monitoring the state of your device. Before beginning a measurement, it is recommended to check these parameters to ensure best results.

Light intensity and balance

The detector signal is determined through the calculation formula (see "signal value" on page 5):

- Channel 1 (I_1) counts measured on diode 1
- Channel 2 (I_2) counts measured on diode 2

Before carrying out a measurement, both diodes must be balanced: This means roughly the same amount of light should fall on both diodes, i.e. Channel 1 and Channel 2 should have roughly the same number of counts.

Zero glass position

Ideally before carrying out a measurement, the position of the zero glass should be roughly 0 (Extended Dynamic Range OFF). This ensures a maximum measurement range for both positive and negative peaks. The zero glass position can be recalculated via the Adjust command.



LED current

The actual electrical current from the light source is displayed in % and mA units. This value can be used to monitor the aging of the LED. However, this only applies if the same total number of counts is compared over time. The LED current in % value is normalized to LED power factor 1. The LED current in mA is not normalized.

9.2 LAN

Go through the following steps, in case no connection between the computer and the devices can be established. Check after each step if the problem is solved. If the problem cannot be located, call the Technical Support.

1. Check the status of the LAN connection in the Windows task bar:

-  Connected
-  Connection not established

If no connection was established, test the following:

- Is the router switched on?
 - Is the patch cable connected correctly to the router and the computer?
2. Check the router settings:
- Is the router set to DHCP server?
 - Is the IP address range sufficient for all the connected devices?
3. Check all connections:

- Are the patch cable connected to the LAN ports and not the WAN port?
 - Are all cable connections between devices and router correct?
 - Are the cables plugged in tightly?
4. If the router is integrated into a company network, pull out the patch cable from the WAN port.
 - Can the devices communicate with the computer, even though the router is disconnected from the company network?
 5. Turn off all devices, router, and computer. First switch on the router and wait until it has successfully completed its self-test. Firstly, turn on the router and secondly turn on the devices and the computer.
 - Has this been successful?
 6. Replace the patch cable to the device with that no connection could be established.
 - Has this been successful?
 7. Make sure that the IP port of the device matches the port in the chromatography software.

9.3 Device problems

The performance of the detector is largely dependent on the performance of the HPLC system.

- Noise can be related to pump stability, the flow cell cleanliness, lamp quality, mobile phase composition and other factors.
- Drift is usually related to long-term changes in the environment, such as detector warm-up or fluctuations in temperature and mobile phase composition.

Further Measures

- Install the maintenance software (Service Tool).
- Save device information and send it to KNAUER.
- Inform technical support.

9.4 System messages

If other system messages are displayed besides those listed below, please turn the detector off and then on. Inform the Technical Support of the manufacturer in case the system message repeats itself.

The system messages are sorted alphabetically.

Message	Cause	Solution
"Autozero failed. Zero glass adjustment failed"	Autozero not possible due to failed zero glass adjustment.	Repeat zero glass adjustment procedure, then try again.
"Device busy"	Internal operations have not yet been concluded.	Wait until the device has completed the process.
"External error"	External error, outside the detector.	1. Check the external devices and cable connections. 2. Check the system to locate and remove the error.
"Hardware failure"	A serious hardware failure has been discovered.	Restart detector. If system message persists, contact Technical Support.

Message	Cause	Solution
"Instrument in standby mode"	Command not allowed during standby mode.	Quit standby.
"Leak sensor failed"	Leak sensor sensor was not found or does not react.	Restart detector. If the leak sensor cannot be found again, contact the Technical Support.
"Leak was detected"	A leak was discovered by the leak management system.	<ol style="list-style-type: none"> 1. Switching off the detector. 2. Find and remove the leak. 3. Restart detector.
"Not ready. Zero glass adjustment failed"	Operation not possible due to failed zero glass adjustment.	Repeat zero glass adjustment procedure, then try again.
"Operation not allowed in current state"	A command has not been completed (e. g. zero glass moving, flush time running, etc.).	Wait until command is finished, try again.
"Optimal light intensity not reached"	Air bubbles in sample or reference cell.	<ol style="list-style-type: none"> 1. Flush detector.
	Dirty flow cell or solvents.	<ol style="list-style-type: none"> 2. Clean flow cell and flush with fresh solvents.
	Defect LED (likely cause when LED operating hours exceed 20,000 h) or defect flow cell.	<ol style="list-style-type: none"> 3. Restart detector. If system message persists, contact Technical Support.
"Preamplifier malfunction. No data acquired"	Defect preamplifier.	Restart detector. If system message persists, contact Technical Support.
"Temperature control failed"	The upper temperature limit was exceeded caused by a defective heater or mainboard.	Restart detector. If system message persists, contact Technical Support.
"Temperature profile failed"	The detector does not reach internal temperature set point, possibly due to defective temperature sensor, mainboard and/or heater.	Restart detector. If system message persists, contact Technical Support.
"Zero glass adjustment failed"	Air bubbles in sample or reference cell.	Flush detector.
"Zero glass drive failure"	Defective or blocked motor, loose cable, or dirty or defective light barrier	Restart detector. If system message persists, contact Technical Support.

9.5 Proceeding with tasks after a leak

- Prerequisites**
- Detector is switched on (see page 29).
 - Have a cloth for drying at hand.

Procedure

1. Remove the leak.
2. Using the cloth, dry the leak tray.
3. To acknowledge the error message, press the standby button ①.

Figure



- Next Steps** Bring the detector into service.

10. Maintenance and care

Proper maintenance of your HPLC device will ensure successful analyses and reproducible results. In this chapter, you find the information relevant for maintenance, care and storage. Additionally, you find instructions for maintenance tasks that may be performed by the customer. In case there are any maintenance tasks on that you do not find instructions here, contact your supplier or the Technical support.



Note: All wetted components of a device, e. g. flow cells of detectors, have to be flushed with isopropanol first and water second before being maintained, disassembled or disposed.

- Maintenance contract** The detector may only be opened by the Technical Support of KNAUER or any company authorized by KNAUER. This maintenance work is covered by a separate maintenance contract.

- Organic eluents** Organic eluents are toxic above a certain concentration. Ensure that work areas are always well-ventilated! When performing maintenance tasks on the detector, always wear safety glasses with side protection, protective gloves, and a lab coat.

10.1 User tasks and intervals

- GLP data** Using the Mobile Control or the software you can read out the operating hours of the detector. You find a detailed description on how to read out GLP data in the respective instructions.

Operating hours

20000

Measures

Replace LED

- User tasks** Users may perform the following maintenance tasks themselves:

- Clean flow cell
- Check calibration (validation).
- Check the validation value.

- Regularly check if all fittings are tight (5 Nm for stainless steel fittings, 0.5 Nm for PEEK fittings).
- All smooth surfaces of the device can be cleaned with a mild, commercially available cleaning solution, or with isopropanol.

NOTICE

Device defect

Intruding liquids can cause damage to the device.

- Place solvent bottles next to the device or in a solvent tray.
- Moisten the cleaning cloth only slightly.

10.2 Check calibration/validation

Prerequisites Calibration solution has been prepared: 350 mg sucrose is weighed in a 100 ml volumetric flask and filled to the mark with deionized water.

Auxiliary material

- calibration solution
- deionized water
- syringe

Procedure

1. Open the flush valve.
2. Flush the detector for 5 min with deionized water at 1 ml/min.
3. Close the flush valve.
4. Continue to flush at the same flow rate until the baseline drift is below 1 μ RIU/h.
5. Push autozero.
6. Remove the capillary from the IN port.
7. Fill the syringe with the prepared calibration solution.
8. Install the syringe on the IN port.
9. Slowly and carefully inject the sucrose solution into the detector IN port.
10. Wait until the baseline is stable.

Result When the baseline is stable, the measured value is read out. This value should be 512 μ RIU \pm 5 %.

Next Steps Repeat the process in case the result is not achieved.

10.3 Preparing the detector for storage or transport

Pay attention that all hoses and capillaries have been emptied or filled with flushing solution (e. g. isopropanol) before storage. To prevent algae formation, do not use pure water.

We recommend the same ambient conditions (temperature range and humidity) for storage as during operation (see Page 39).

Prerequisites Flow cell has been filled with isopropanol.

Detector has been switched off.

Tools Open-end wrench

⚠ DANGER**Life-threatening injuries**

Health danger if getting in contact with toxic, infectious or radio-active substances.

- Before disposing of the device or sending it away for repair, you are required to decontaminate the device in a technically correct manner.

Procedure**Figure**

1. Using the open-end wrench, disconnect the first capillary and close the opening with a hole plug.
2. Using the open-end wrench, disconnect the second capillary and close the opening with a hole plug.
3. Disconnect the power cable from the connector ① on the rear side of the detector.

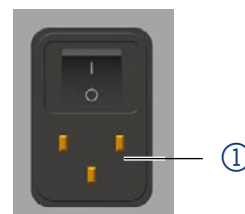

Next Steps If you want to ship the device, reuse the packaging materials that you received with the delivery.

11. Technical data

11.1 Main features

	AZURA® Detector RID 2.1L	AZURA® Detector RID 2.1L HighFlow
Detector type	Analytical refractive index detector	Preparative refractive index detector
Light source	Long-life LED	
Refractive index range	1.00-1.75 RIU	
Noise	± 2.5 nRIU	± 50 nRIU
Drift	200 nRIU/h	2000 nRIU/h
Linearity	>1000 µRIU	>4000 µRIU
Temperature control	OFF, 30-55 °C (1 °C steps)	
Max. flow rate	10 ml/min (pure water)	100 ml/min (pure water)
Time constants	0.00 / 0.01 / 0.02 / 0.05 / 0.1 / 0.2 / 0.5 / 1.0 / 2.0 / 5.0 / 10.0 s	
Autozero	Full range	
Flow cell	5 bar backpressure resistance (flow cell included)	
Flow cell volume	15 µl	9 µl
Wetted materials	Stainless steel/fused silica/PTFE	Stainless steel/fused silica/PTFE/PEEK
GLP	Detailed report about lamp recognition, operating hours, lamp operating hours, number of lamp ignitions.	

11.2 Communication

Max. data rate	100 Hz (LAN), 20 Hz (analog)
Interfaces	2 x LAN (RJ-45, Dual IP-Stack), USB (Service only), RS-232 (SUB-D 9), pin header, analog (RCA Cinch connector)
Control	Front panel, Mobile Control, software, event control, analog, terminal protocol
Inputs	Error (IN), Start (IN), Autozero, Flush (IN)
Outputs	Event 1, Start (OUT), Error (OUT), +5 V, Valve +24 V
Analog outputs	1 x 0-2.5 V scalable, 20 bit, offset adjustable

11.3 General

Power supply	100-240 V, 50-60 Hz, 65 W
Dimensions	361× 158× 523 mm (W × H × D)
Weight	10.8 kg
Leak sensor	Yes (internal and external leak management)
Ambient conditions	Temperature range: 4-40 °C (39.2-104 °F) Humidity: below 90 % (non-condensing)

12. Chemical compatibility of wetted materials



Note: The user takes the responsibility for using the fluids and chemicals in an appropriate and safe way. If there is any doubt, contact the Technical Support of the manufacturer.



Note: The use of tetrahydrofuran (THF) as solvent may lead under certain circumstances to increased noise and greater drift. This can be observed especially when using unstabilized and not devitrified THF, but also when operating a HPLC system in recycling mode. Therefore, when working with THF and a detector, KNAUER recommends the use of stabilized THF and a THF resistant degasser. In addition, we also recommend to avoid the delivery of THF in a cycle (e. g. Recycling-HPLC). If the noise and/or drift is getting worse over a longer period of time, KNAUER recommends to regularly flush the reference cell of the detector with new solvent.

12.1 General

The device is very resistant against a variety of commonly used eluents. However, make sure that no eluents or water come in contact with the device or enter into the device. Some organic solvents (such as chlorinated hydrocarbons, ether) may cause coating damage or loosen glued components by improper handling. Even small quantities of other sub-

stances, such as additives, modifiers, or salts can influence the durability of the materials. Exposure time and concentration have a high impact on the resistance.

The following list contains information about the chemical compatibility of all wetted materials which are used in devices made by KNAUER. The data bases on a literature research on the manufacturer specifications of the materials. The wetted materials of this device are listed in the chapter "Technical data".

All resistances mentioned here are for use at temperatures up to 40 °C, unless stated otherwise. Please note that higher temperatures can significantly affect the stability of different materials.

12.2 Plastics

Polyetheretherketone (PEEK)

PEEK is a durable and resistant plastic and, next to stainless steel, the standard material in HPLC. It can be used at temperatures up to 100 °C and is highly chemical resistant against almost all commonly used solvents in a pH range of 1-12,5. PEEK is potentially moderate resistant against oxidizing and reducing solvents.

Therefore, following solvents should not be used: Concentrated and oxidizing acids (such as nitric acid solution, sulfuric acid), halogenated acids (such as hydrofluoric acid, hydrobromic acid) and gaseous halogens. Hydrochloric acid is approved for most applications.

In addition, following solvents can have a swelling effect and may have an impact on the functionality of the built-in components: Methylene chloride, THF and DMSO in any concentration such as acetonitrile in higher concentrations.

Polyethylene terephthalate (PET, outdated PETP)

PET is a thermoplastic and semi-crystalline material with high wear resistance. It is resistant against diluted acids, aliphatic and aromatic hydrocarbons, oils, fats and alcohols, but not against halogenated hydrocarbons and ketones. Since PET belongs chemically to esters, it is not compatible with inorganic acids, hot water and alkalis. Maximum operating Temperature: up to 120 °C.

Polyimide (Vespel®)

This material is wear-resistant and permanent resilient thermally (up to 200 °C) as well as mechanically. It is chemically broadly inert (pH range 1-10) and is especially resistant against acidic to neutral and organic solvents, but vulnerable to pH strong chemical or oxidizing environments: It is incompatible with concentrated mineral acids (such as sulfuric acid), glacial acetic acid, DMSO and THF. In addition, it will be disintegrated by nucleophilic substances like ammonia (such as ammonium salts under alkaline conditions) or acetate.

Ethylene-tetrafluorethylene copolymer (ETFC, Tefzel®)

This fluorinated polymer is highly resistant against neutral and alkaline solvents. Some chlorinated chemicals in connection with this material should be handled with care. Maximum operating Temperature is 80 °C.

Perfluorethylenpropylen-Copolymer (FEP), Perfluoralkoxy-Polymer (PFA)

These fluorinated polymers hold similar features as PTFE, but with a lower operation temperature (up to 205 °C). PFA is suitable for ultrapure applications, FEP can be used universally. They are resistant against almost all organic and inorganic chemicals, except elemental fluorine under pressure or at high temperatures and fluorine-halogen compounds.

Polyoxymethylene (POM, POM-H-TF)

POM is a semi-crystalline, high-molecular thermoplastic material which stands out due to its high stiffness, low friction value and thermic stability. It can even substitute metal in many cases. POM-H-TF is a combination of PTFE fibres and acetal resin and is softer and has better slip properties as POM. The material is resistant against diluted acids (pH > 4) as well as diluted lyes, aliphatic, aromatic and halogenated hydrocarbons, oils and alcohols. It is not compatible with concentrated acids, hydrofluoric acid and oxidizing agent. Maximum operating Temperature is 100 °C.

Polyphenylene sulfide (PPS)

PPS is a soft polymer which is known for its high break resistance and very high chemical compatibility. It can be used with most organic, pH neutral to pH high, and aqueous solvents at room temperature without concerns. However, it is not recommended for using with chlorinated, oxidizing and reducing solvents, inorganic acids or at higher temperatures. Maximum operating temperature: 50 °C

Polytetrafluorethylene (PTFE, Teflon®)

PTFE is very soft and anti-adhesive. This material is resistant against almost all acids, lyes and solvents, except against fluid sodium and fluoride compounds. In addition, it is temperature-resistant from -200 °C to +260 °C.

System AF™

This amorphous perfluorinated copolymer is inert against all commonly used solvents. However, it is soluble in perfluorinated solvents like Fluorinert® FC-75 and FC-40, and Fomblin perfluor-polyether solvents from Ausimont. In addition, it is affected by Freon® solvents.

Polychlorotrifluorethylene (PCTFE, Kel-F®)

The semi-crystalline thermoplastic material is plasticizer-free and dimensionally stable, even in a wide temperature range (-240 °C to +205 °C). It is moderately resistant against ether, halogenated solvents and toluene. Halogenated solvents over +60 °C and chlorine gas should not be used.

Fluorinated rubber (FKM)

The elastomer consisting of fluorinated hydrocarbon stands out due to a high resistance against mineral oils, synthetic hydraulic fluids, fuels, aromatics, and many organic solvents and chemicals. However, it is not compatible with strong alkaline solvents (pH value >13) like ammonia, and acidic solvents (pH value <1), pyrrole and THF. Operating temperature: Between -40 °C and +200 °C.

Perfluorinated rubber (FFKM)

This perfluoro elastomer has a higher fluorine content as fluorinated rubber and is therefore chemically more resistant. It can be employed at higher temperatures (up to 275 °C). It is not compatible with Pyrrole.

12.3 Non-metals

Diamond-like carbon (DLC)

This material is characterized by a high hardness, a low coefficient of friction and thus low wear. In addition, it is highly biocompatible. DLC is inert against all acids, alkalis and solvents commonly used in HPLC.

Ceramic

Ceramic is resistant against corrosion and wear and is fully biocompatible. An incompatibility against acids, alkalis and solvents commonly used in HPLC is not known.

Alumina (Al₂O₃)

Due to their high resistance to wear and corrosion, alumina ceramic is used as a coating for mechanically stressed surfaces. It is a biocompatible material with low thermal conductivity and low thermal expansion.

Zirconium oxide (ZrO₂)

Zirconia ceramics are characterized by their high mechanical resistance, which makes them particularly resistant to wear and corrosion. It is also biocompatible, has low thermal conductivity and is resistant to high pressures.

Sapphire

Synthetic sapphire is virtually pure monocrystalline alumina. It is biocompatible and very resistant to corrosion and wear. The material is characterized by a high hardness and a high thermal conductivity.

Ruby

Synthetic ruby is monocrystalline alumina and gets its red color by the addition of some chromium oxide. It is biocompatible and very resistant to corrosion and wear. The material is characterized by a high hardness and a high thermal conductivity.

Mineral wool

This insulating material consists of glass or stone wool fibres and isolates in high oxidizing conditions and at high temperatures. Mineral wool is valid as commonly inert against organic solvents and acids.

Glass, glass fibre, quartz, quartz glass

These mineral materials are resistant against corrosion and wear and are mostly chemical inert. They are compatible with oils, fats and solvents and show a high resistance against acids and lyes up to pH values of 3-9. Concentrated acids (especially hydrofluoric acid) may embrittle and corrode the minerals. Lyes may ablate the surfaces slowly.

12.4 Metals

Stainless steel

Stainless steel is, apart from PEEK, the standard material in HPLC. Steels with WNr. 1.4404 (316L) are used, or with a mixture of higher compatibility.

They are inert against almost all solvents. Exceptions are biological applications which are metal ion sensible, and applications with extreme corrosive conditions. These steels, in comparison to commonly used steels, are increasingly resistant against hydrochloric acid, cyanides and other halogen acids, chlorides and chlorinated solvents.

The use in ion chromatography is not recommended. In case of electrochemical applications, a passivation must be executed first.

Hastelloy®-C

This nickel-chrome-molybdenum alloy is extremely resistant to corrosion, especially against oxidizing, reducing and mixed solvents, even at high temperatures. This alloy may be used in combination with chlor, formic acid, acetic acid and saline solutions.

Titanium, titanium alloy (TiA16V4)

Titanium has a low weight and a high hardness and stability. It stands out due to its very high chemical compatibility and biocompatibility. Titan is applied when neither stainless steel nor PEEK are usable.

13. Repeat orders

	Name	Order number
Devices	Analytical refractive index detector with flow cell	ADD31
	Preparative refractive index detector with flow cell	ADD33
Accessory kits	AZURA® accessory kit	FZA02
	AZURA® RID 2.1L accessory kit	FDD
	AZURA® RID 2.1L HighFlow accessory kit	FDD38
Documents	AZURA® Detector RID 2.1L / HighFlow Instructions	V6750
	Installation Qualification document	VIQ_INST
	Operation Qualification document	VOQ_RID
Leak management	Corrugated hose, 16 cm, PE grey	A9846-1
	Funnel	P6431
	Exhaust	P6432
	Capillary guide top	P6424
	Capillary guide side	P6425
Mobile Control	Mobile Control license with 10 " touchscreen	A9607
	Mobile Control Chrom license with 10 " touchscreen	A9608
	Mobile Control licence	A9610
	Mobile Control Chrom license	A9612
Tools	AZURA® tool kit	A1033
	Luer-lock Glass syringe, 10 ml	A0574

14. Legal information

14.1 Transport damage

The packaging of our devices ensures the best possible protection against transport damage. Check the devices for signs of transport damage. In case you notice any damage, contact the technical support and the forwarder company within three workdays.

14.2 Warranty conditions

The factory warranty for the device is contractually agreed. During the warranty period, any components with material or design-related defects will be replaced or repaired by the manufacturer free of charge. Please refer to our website for further information on terms and conditions.

All warranty claims shall expire in the event that any unauthorized changes are made to the device. This warranty excludes the following:

- Accidental or willful damage
- Damage or errors caused by third parties that are not contractually related to the manufacturer at the time the damage occurs
- Wear parts, fuses, glass parts, columns, light sources, cuvettes and other optical components
- Damage caused by negligence or improper operation of the device and damage caused by clogged capillaries
- Packaging and transport damage

In the event of device malfunctions, directly contact the manufacturer.

KNAUER Wissenschaftliche Geräte GmbH
Hegauer Weg 38
14163 Berlin, Germany

Telephone: +49 30 809727-111
Telefax: +49 30 8015010
E-Mail: support@knauer.net
Internet: www.knauer.net

14.3 Warranty seal

A warranty seal is attached on some devices. The warranty seal is color-coded. A blue seal is used by the assembly or technical support of

KNAUER for devices to be sold. After repair, service technicians stick an orange seal in identical position. If unauthorized persons interfere with the

device or the seal is damaged, the warranty claim becomes void.



14.4 Declaration of Conformity

The Declaration of Conformity accompanies the product as a separate document and is available online: <https://www.knauer.net/de/Support/Declarations-of-conformity>

14.5 Disposal

Hand in old devices or disassembled old components at a certified waste facility, where they will be disposed of properly.

14.5.1 AVV-marking Germany

According to the German "Abfallverzeichnisverordnung" (AVV) (January, 2001), old devices manufactured by KNAUER are marked as waste electrical and electronic equipment: 160214. 160214.

14.5.2 WEEE registration

KNAUER as a company is registered by the WEEE number DE 34642789 in the German "Elektroaltgeräteregister" (EAR). The number belongs to category 8 and 9, which, among others, comprises laboratory equipment.

All distributors and importers are responsible for the disposal of old devices, as defined by the WEEE directive. End-users can send their old devices manufactured by KNAUER back to the distributor, the importer, or the company free of charge, but would be charged for the disposal.

14.5.3 Eluents and other operating materials

All eluents and other operating materials must be collected separately and disposed of properly.

All wetter components of a device, e. g. flow cells of detectors or pump heads and pressure sensors for pumps, have to be flushed with isopropanol first and water afterwards before being maintained, disassembled or disposed.

15. HPLC glossary

Term	Definition
Absorption	The process of retention in which the solute partitions into a liquid-like coating.
Adsorption	A process of retention in which the interactions between the solute and the surface of an adsorbent dominate.
Analytical	analysis and determination in terms of volume for HPLC samples (see: preparative).
Response time	The time required, after a stepwise change in the composition in the detector cell, for the output signal to reach a predetermined percentage (67 %) of the new equilibration value. For example, if the time constant is 1 s, it will take 1 s to attain 67 % the value of the new signal.
Chromatogram	Record of a detector signal, depending on output volume of mobile phase and time

Term	Definition
Degasser	Degasser module for fluids
Detector	device measuring the composition or the quantity of a substance.
GLP	Good laboratory practice Good Laboratory Practice)
Gradient	Time-dependent composition of solvent (mobile phase) on low-pressure or high-pressure side of system
Isocratic	Mode of sample separation where the composition of a solvent remains constant
Calibration	A process for correcting measuring values by the value that a measuring device deviates from the standard.
Capillary	thin metal or PEEK pipe that connects components and devices within the chromatography system
Correction factor	Factor that arithmetically corrects device-related deviations from measuring values.
Solvent	mobile solvent transporting substances to be separated or isolated through the column
Luer-Lock	standardized connection system between syringes and cannulae
Mobile phase	mobile solvent transporting substances to be separated or isolated through the column
Packaging material	The adsorbent, gel, or solid support used in the chromatography column.
Preparative	Isolating the maximum amount of a substance in a short amount of time in a required purity.
Sample	Mixture of different components, which are to be separated using chromatography. They are transported by the mobile phase and dissolved from the column.
Sample loop	A loop, which is separated from the system by the valve, that contains sample first. After switching the valve, the eluent flows through the loop and is flushed to the column.
Retention time	The time required from an injection of a substance until the maximum concentration of a substance becomes visible.
Backflushing	Backflushing of columns or precolumns to separate heavily retarding substances by changing the flow direction.
Column	Pipe with final closures, which allow the mobile phase to pass. The pipe contains the packing materials.
Stationary phase	The immobile phase involved in the chromatographic process. It is the liquid or the liquid film on the surface of the packing material.
Dead volume	Volume of capillaries and system components between mixing chamber, injector and column as well as between column and detector.
Carrier material	Refers to the support that is used to attach the active ligand, usually by a covalent bond.

Index

A

absorption 46
accessories 44
adsorption 46
ambient conditions 40
Analog outputs 40
analog output scaling 29
analytical 46
APIPA 22
Autozero 27, 39
AVV-marking 46
AZURA Neo 4

B

backflushing 47
backpressure 13
backpressure regulator 16
base line instability 1

C

calibration 38, 47
capillaries 47
 connecting 13
care 37
carrier material 47
chemical compatibility 40
chromatogram 46
column 47
communication 40
connector assignment 23
contamination 9
control 3, 40
correction factor 47

D

data rate 3, 28, 40
 optimizing 28
dead volume 13, 47
Declaration of Conformity 7, 46
decommissioning 8
decontamination 9
degasser 47
detector 47
 switching off 32
 switching on 30
 type 39
device problems 35
dimensions 40
disposal 9, 46
drift 39

E

eluent 1
eluent 46
Error analysis 34
Extended Dynamic Range 3, 29

F

Firmware Wizard 21
flow cell
 flushing 31
 type 39
flow path 5
flow rate 39
functionality tests 33
functional principle 4

G

glossary 46
GLP 30, 39, 47
GPC 1
gradient 47

H

HPLC 1, 46

I

initial startup 12
inputs 40
Installation Qualification (IQ) 7, 33
integrator port 25
intended use 1
interfaces 40
IP address
 DHCP 20
 static 19
isocratic 47

L

LAN
 company network 19
 connecting device with PC 17-22
 settings 17
 troubleshooting 34
leak
 management 12
 proceeding 37
 sensor 30, 40
LED current 34
LED panel 25
LED power factor 26, 29
legal information 45
light intensity 34
light source 39
 durability 29
linearity 39
Luer-Lock 47

M

main switch 31, 33
maintenance 37
Mobile Control 3, 19, 25, 26, 31

mobile phase 47

N

network settings 26

noise 39

O

offset 29

operating environment 10

operating ranges 2

operation 25

Operation Qualification (OQ) 33

optical bench 3

optical path 4

outputs 40

P

packaging material 47

peaks 1, 28

performance features 3

power supply 12, 40

preparative 47

pressure 1

R

refractive index range 39

remote control 22

repeat orders 44

response time 46

retention time 47

router 18

S

safety

equipment 7

instructions 7-9

target group 7

sample 47

sample loop 47

scope of delivery 7

SEC 1

sensitivity 29

settings

default 26

setup 10

signal mode 27

signal value 5

Snell's Law of refraction 4

software 25

solvent 47

space requirements 11

standby 26, 32

stationary phase 47

storage 38

symbols and signs 9

system

integrating device 16

system messages 35

T

technical data 39

temperature 1, 26

temperature control 3, 27, 39

temperature sensitivity 10

time constant 28, 39

transport 38

damage 45

troubleshooting 34

U

unpacking 11

V

validation 38

views 2

W

warning notifications 9

warranty

conditions 45

seal 45

WEEE registration 46

weight 40

wetted materials 39, 40

Z

zero glass position 34

Science Together



Latest KNAUER instructions online:
www.knauer.net/library

KNAUER
Wissenschaftliche Geräte GmbH
Hegauer Weg 38
14163 Berlin

Phone: +49 30 809727-0
Fax: +49 30 8015010
E-Mail: info@knauer.net
Internet: www.knauer.net