

Smartline

▶ Detector 2520 User Manual

V5160A



Table of Contents

Note For your own safety, **read** the manual and **always** observe the warnings and safety information on the device and in the manual!

Intended use	6
Local network and automatic configuration	6
Laboratory use	6
Eluents	7
Features	9
Safety and security	10
Definition of Personal and Material Damage	12
Decontamination	12
Symbols and labels	13
Installation	14
Packaging and transport	14
Remove fastening material	14
Protective film on the display	14
Installation site	14
Space requirements	14
Power Supply and Connection	15
Scope of supply	15
Checking the scope of supply	15
Device overview	16
Front view of the device	16
Device door with input field and display	16
Front view of the device with door open	16
Overview of the basic buttons	17
Rear view of the device	18
Startup	19
Checklist before initial operation	19
Installation of the flow cell	19
Changing the optical path length of a preparative flow cell	21
Connecting the detector to other devices	23
Electrical connections	23
Connecting the connector strip with the cable	23
Terminal strip Event and remote control on the rear of the device	24
Manual configuration of the control signals (events)	25
Control of the detector with chromatography software	26

Connecting to a local area network (LAN)	27
Configuring the LAN Settings	27
Connecting the Cables	27
Configuring the Router	28
Integrating the LAN into a Company Network	28
Controlling Several Systems Separately in a LAN	29
Controlling the detector	30
Switching the detector on	30
Selecting the wavelength	31
Controlling the main menu	31
Selecting the Setup menu	32
Selecting the GLP menu	32
Selecting the Link menu	32
Selecting the Program menu	32
Controlling the Setup menu	33
Structure of the Setup menu	34
Parameters of the Setup menu	36
Controlling the GLP menu	37
Structure of the GLP menu	38
Parameters of the GLP menu	39
Controlling the Program menu	39
Creating a program	40
Running a program	41
Changing a program	42
Deleting a program	42
Creating a program with preselectable start time	43
Controlling the Link menu	44
Creating a link	45
Executing a link	45
Deleting a link	47
Maintenance and care	48
KNAUER Technical Support	48
Maintenance contract	48
Cleaning the flow cell	48
Purging the flow cell	49
Cleaning the lens of an analytical flow cell	49
Cleaning the fiber optics of a preparative flow cell	50
Replacing the flow cell	51
LAN	52
Cleaning and caring for the device	53
Disposal	54
Storage	54
System messages and troubleshooting	55

Technical data	59
Delivery program	61
Devices and accessories	61
Re-order	61
Available Flow Cells	62
Preparative Flow Cells	63
Fiber Optics Preparative Flow Cells	64
Test Cells	65
Flow cell replacement parts	65
Legal information	66
Warranty Conditions	66
Transport Damage	66
HPLC Glossary	67
Table of Figures	69
Index	70
Annex	72
Replacing the flow cell on the fiber optics version of 2520	72
Inserting the flow cell	73
Purging the flow cell	74
Removing the flow cell	74
Storing a flow cell	75
Inspecting the flow cell	75
Declaration of Conformity	76

To whom it may concern In case you prefer a French language user manual for this product, submit your request including the corresponding serial number via email or fax to KNAUER:

- support@knauer.net
- +49 30 8015010

Thank you.

A qui que ce soit Si jamais vous préféreriez un manuel en français pour ce produit contacter KNAUER par email ou par fax avec le no. de série:

- support@knauer.net
- +49 30 8015010

Merci beaucoup.

Intended use

HPLC High performance liquid chromatography (HPLC) is a method for separating compounds, determining substances and measuring their concentration. The UV detector is the most frequently used detector in HPLC.

Smartline Detector 2520



Detectors are the decisive link in making the analytical information of chromatographic separation measurable and the visible. They always convert physical information into electrical signals (analog signals).

The self-calibration of the Smartline Detector 2520 guarantees operation without external settings. Type and combination of the installed lamps as well as the transmission of the corresponding installed flow cell are analyzed and used for the automatic setting of the integration time, in order to achieve a high level of sensitivity.

Checking intended use

- Use the device only for applications that fall within the range of the intended use. Otherwise, the protective and safety equipment of the device could fail.

Local network and automatic configuration

The detector is controlled either by means of the input field on the front of the device, or by means of the chromatography software.

Remote control Normally, the detector is controlled by the chromatography software through a local network (LAN).

Automatic configuration The detector connected to the local area network (LAN) is automatically detected by the chromatography software.

Device status When used in a local area network (LAN), the system status of the detector can be checked using the chromatography software.

LAN setting Ex works, the detector is set to DHCP (Dynamic Host Configuration Protocol). This means that the detector is automatically assigned an IP address within the local network. In the Setup menu, this setting can be modified manually.

Laboratory use

- Biochemistry analysis
- Chemical analysis
- Food analysis
- Pharmaceutical analysis
- Environmental analysis

Eluents

Even small quantities of other substances, such as additives, modifiers, or salts can influence the durability of the materials.

If there is any doubt, contact the Technical Support of the manufacturer.

Suitable solvents

- Acetate buffer solutions
- Acetone at 4 °C–25 °C (39.2 °F–77.0 °F)¹
- Acetonitrile²
- Benzene
- Carbon dioxide (liquid 99.999 % CO₂)
- Chloroform
- Dilute acetic acid (e.g. 0.1–1 %) at 25 °C/77.0 °F
- Dilute ammonia solution
- Dilute sodium hydroxide (1 M)
- Ethyl acetate
- Ethanol
- Formiate buffer solution
- Isopropanol
- Methanol
- Phosphate buffer solutions (0.5 M)
- Toluol
- Water

1. valid for the specified temperature range
2. not recommended in combination with PEEK small parts and PEEK capillary

Less suitable solvents

- Diethylamine (0.1 %) (DEA)
- Dilute phosphoric acid
- Dimethyl sulfoxide (DMSO)
- Methylene chloride¹
- Slightly volatile solvents
- Tetrahydrofuran (THF)¹
- Triethylamine (0.1 %) (TEA)
- Trifluoroacetic acid (0.1 %) (TFA)

1. not recommended in combination with PEEK small parts and PEEK capillary

Not suitable solvents

- Concentrated mineral and organic acids
- Concentrated bases
- Halogenated hydrocarbons, e.g. Freon[®]
- Perfluorinated solvents, e.g. Fluorinert[®] FC-75, FC-40
- Perfluorinated polyether, e.g. Fomblin[®]
- Solvents containing particles

Solvents not suitable for degassers

- Azides
- Benzene
- Carbon dioxide (liquid 99.999 % CO₂)
- Concentrated mineral and organic acids
- Concentrated bases
- Dilute sodium hydroxide (1 M)
- Halogenated hydrocarbons, e.g. Freon[®]
- Hexafluoroisopropanol
- Hexanes (60 % *n*-Hexane)
- Hydro fluoro solvents
- Perfluorinated solvents, e.g. Fluorinert[®] FC-75, FC-40
- Perfluorinated polyether, e.g. Fomblin[®]
- Solvents containing particles

Features

- Wavelength range 190-750 nm
- The beam guidance is designed so that no chromatic aberration occurs and thus the best possible useful signal is available, independent of the selected wavelength.
- Automatic recording and storage of the device-specific characteristics that are important for GLP (Good Laboratory Practice), OQ (Operation Qualification) and for the device service and device history.
- Self-running and up-to-date device status diagnostics.
- Control with chromatography software possible.
- Easy integration of the detector into complex chromatography systems.
- High data rates for fast chromatography.
- Flexible options for use in the entire field of LC applications due to a comprehensive range of flow cells for the detectors, from nano HPLC cells with flow rates ≈ 100 nl/min to preparative flow cells with 10 l/min.

Safety and security

Professional group The user manual addresses persons who are qualified as chemical laboratory technicians or have completed comparable vocational training.

The following knowledge is required:

- Fundamental knowledge of liquid chromatography
- Knowledge regarding substances that are suitable only to a limited extent for use in liquid chromatography
- Knowledge regarding the health risks of chemicals
- Participation during an installation of a device or a training by the company KNAUER or an authorized company.

If you do not belong to this or a comparable professional group, you may not perform the work described in this user manual under any circumstances. In this case, please contact your superior.

Safety equipment When working with the device, take measures according to lab regulations and wear protective clothing:

- Safety glasses with side protection
- Protective gloves
- Lab coat

What must be taken into account?

- All safety instructions in the user manual
- The environmental, installation, and connection specifications in the user manual
- National and international regulations pertaining to laboratory work
- Original spare parts, tools, and solvents made or recommended by KNAUER
- Good Laboratory Practice (GLP)
- Accident prevention regulations published by the accident insurance companies for laboratory work
- Filtration of substances under analysis
- Use of inline filters
- Once they have been used, never re-use capillaries in other areas of the HPLC system.
- Only use a given PEEK fitting for one specific port and never re-use it for other ports. Always install new PEEK fittings on each separate port.
- Follow KNAUER or manufacturer's instructions on caring for the columns

More safety-relevant information is listed in alphabetical order in the following table:

Topic	Explanations
Flammability	Organic solvents are highly flammable. Since capillaries can detach from their screw fittings and allow solvent to escape, it is prohibited to have any open flames near the analytical system.
Solvent tray	Risk of electrical shock or short circuit if liquids get into the device's interior. For this reason, place all bottles in a solvent tray.
Solvent lines	Install capillaries and tubing in such a way that liquids cannot get into the interior in case of a leak.
Leaks	Regularly check if any system components are leaking.
Power cable	Defective power cables are not to be used to connect the device and the power supply system.
Self-ignition point	Only use eluents that have a self-ignition point higher than 150 °C under normal ambient conditions.
Power strip	If several devices are connected to one power strip, always consider the maximum power consumption of each device.
Power supply	Only connect devices to voltage sources, whose voltage equals the device's voltage.
Toxicity	Organic eluents are toxic above a certain concentration. Ensure that work areas are always well-ventilated! Wear protective gloves and safety glasses when working on the device!

Where is use of the device prohibited?

Never use the system in potentially explosive atmospheres without appropriate protective equipment. For further information, contact the Technical Support of KNAUER.

Taking the device out of operation

At any time, take the device completely out of operation by either switching off the power switch or by pulling the power plug.

Opening the device

The device may be opened by the KNAUER Technical Support or any company authorized by KNAUER only.

Definition of Personal and Material Damage

Possible dangers related to the device are divided into personal and material damage in this user manual.

Category	Explanations
DANGER!	Lethal or very serious injuries can occur.
WARNING!	Serious or moderate injuries can occur.
CAUTION!	Moderate injuries can occur. Device defects can occur.

Decontamination

Contamination of devices with toxic, infectious or radioactive substances poses a hazard for all persons during operation, repair, sale, and disposal of a device.



DANGER!

Danger if getting in contact with toxic, infectious or radio-active substances.







Before disposing off or sending away contaminated devices, commission an expert with the decontamination.

All contaminated devices must be properly decontaminated by a specialist company or the operating company before they can be recommissioned, repaired, sold, or disposed of.

All materials or fluids used for decontamination must be collected separately and disposed of properly.

Symbols and labels

The following symbols and signs can be found on the device, in the chromatography software or in the user manual:

Symbol	Meaning
	High-voltage hazard
	Electric shock hazard
	Electrostatic discharge hazard, damages to system, device, or components can occur.
	General warning sign, moderate injuries can occur and also damages to system, device, or components.
	UV-light hazard, eye injuries can occur.
	Leak hazard, damages to device can occur.
	A device or system marked with CE fulfills the product specific requirements of European directives. This is confirmed in a Declaration of Conformity.

Installation

Packaging and transport

At the factory, all KNAUER devices are carefully packed for safe transport.

Checking for signs of damage during transport

Check the device and accessories for signs of damage that occurred during transport. If the shipment is incomplete or damaged, inform the manufacturing factory within three work days. Also inform the freight carrier about transport damage.

Remove fastening material

The device is held in place and protected by foam inserts at the top and bottom. Please keep the transport box and the foam inserts.

Remove fixation material

- Remove the foam insert on the top of the device.

Removing device from packaging.

- Grip the device at its sides near the front and lift it out of the packaging.

Protective film on the display

During transport, a protective film prevents scratches to the screen of the device.

- Remove the protective film from the display.

Installation site

Installation site requirements

- protect from heavy ventilation
- Humidity: below 90%
- Temperature range: 4–40 °C; 39.2–104 °F
- Sunlight: When setting up the system at the installation location, make sure that it is protected against direct sunlight.

Space requirements

- Side clearance to other devices:
 - If there is a device on one side, min. clearance of 5 cm.
 - If there are devices on both sides, min. clearance of 10 cm.
- At least 30 cm gap to the fan on the rear of the device.

Power Supply and Connection

The device is intended for use with AC power networks of 100-240 V. The supplied power cable is to be used to connect the device to the mains supply.

Power cable Only the supplied power cable is to be used to connect the device to the mains supply. Replace defective power cables only with original accessories from KNAUER. Only use power cables with a permission for use from your country.

In case of queries contact the Technical Support.

Power plug Make sure that the power plug on the rear of the device is always accessible, so that the device can be disconnected from the power supply.

Scope of supply

The delivery consists of:

- Smartline Detector 2520 without flow cell
- Device manual
- Power supply cable Germany 230 V
- Power supply cable United Kingdom (UK), optional
- Power supply cable USA, optional
- RS-232 port cable
- integrator cables
- flat ribbon cables, 10-pin
- LAN network cable (Ethernet patch CAT5e)
- Connector strip, 12-pin
- Stylus (for connector strip)

Use original parts and original accessories

- To maintain best performance, only use original parts and accessories made by KNAUER or a company authorized by KNAUER.

Checking the scope of supply

1. Check whether the device and accessories are complete.
2. If anything is missing, consult with KNAUER Technical Support.

Hotline of KNAUER Technical Support:

European hotline

Languages: German and English
 Available by telephone: 8 am to 5 pm (CET)
 Phone: +49-(0)30-809727-0
 Fax: +49-(0)30-8015010

E-mail: E-mail: info@knauer.net

Device overview

Front view of the device

The input panel and display of the detector are located in the door on the front of the device. **Behind** the door there is the holder for the flow cell with cover plate.

Device door with input field and display

Legend

- ① Display with upper and lower status bar
- ② *AUTO ZERO* key
- ③ Number keys
- ④ Arrow keys
- ⑤ Standby key with LED display

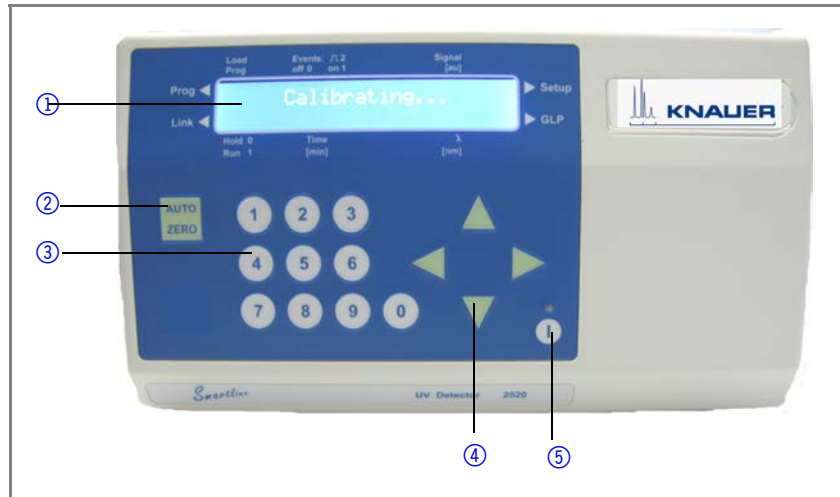



Front view of the device with door open

Legend

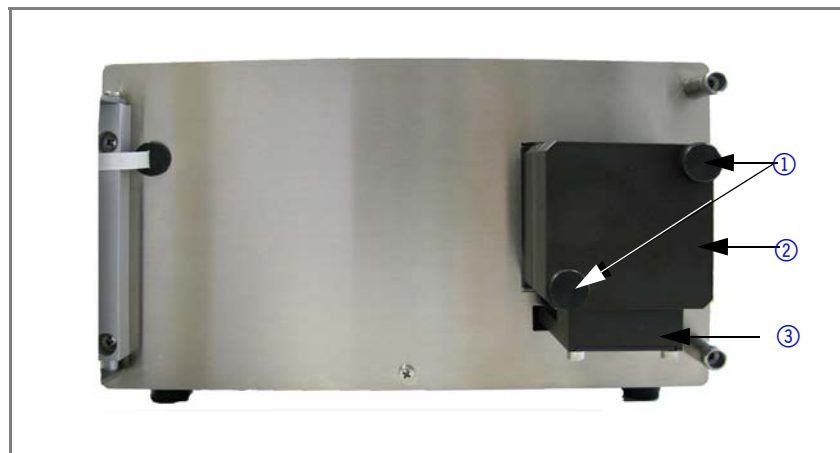
- ① Knurled-head screws
- ② Cover plate with sensor
- ③ Carriage (holder for flow cell)

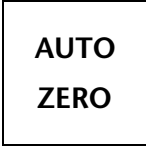
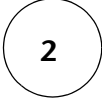

Overview of the basic buttons

Button	Name	Explanation
	Vertical arrow keys	The vertical arrow keys serve to modify the corresponding controlled parameters. They are not used to move between the upper and lower status bar of the display. The upper vertical arrow key also has a special function. Once an error message appears in the display, it can be deleted by pressing the arrow key.
	Horizontal arrow keys	The operation of the horizontal arrow keys moves the cursor to the individual input or switching fields and confirms an entry or selection. If you hold these keys down, you will switch to one of the menus shown to the side of the display (Prog, Link, Setup, GLP).
	<i>AUTO ZERO</i> key	<ol style="list-style-type: none"> 1. Actuating this key triggers a signal auto zero for the currently set wavelength. 2. With the <i>AUTO ZERO</i> key, you return to the main menu.
	Number keys	All ten number keys make possible entry of numeric values at the cursor position.

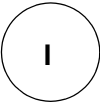
Button	Name	Explanation
	Standby key	Pressing the standby key puts the detector into a power saving mode. Event inputs and communication interfaces remain active. The standby status is indicated by the lit red LED above this key. To switch back on, press the standby key briefly. Calibration is not performed in this case, as the set wavelength has been fixed.

Note To disconnect the detector from the mains power, press the power switch on the rear of the device.

Rear view of the device

The rear of the device contains the mains power connection, power switch, connections for external devices, technical symbols and serial number.

Legend

- ① Serial number
- ② Analog output (scalable)
- ③ LAN network connection
- ④ Serial interface
- ⑤ Fan opening
- ⑥ Terminal strip *Event and remote control*
- ⑦ Power switch
- ⑧ Power connection

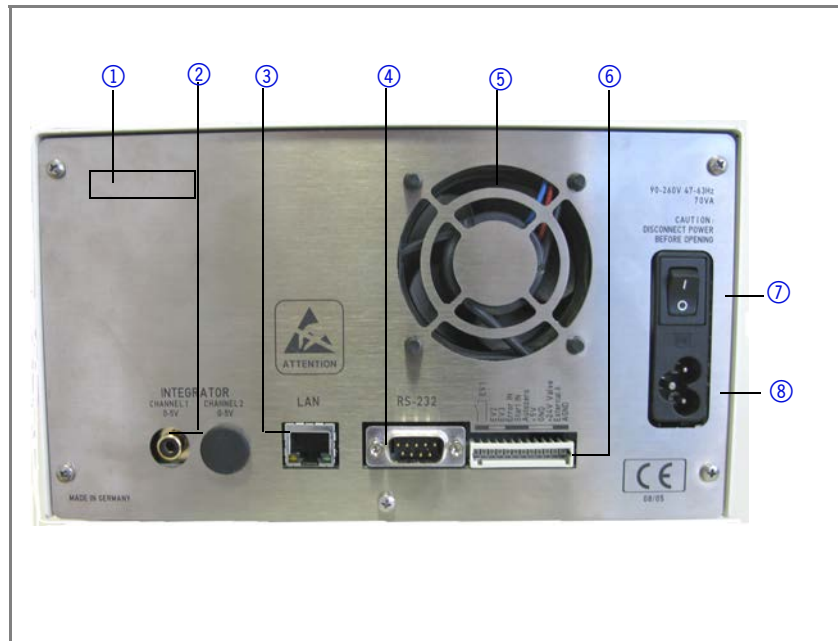

Startup

Checklist before initial operation

Use this checklist to determine whether the detector is ready for initial startup:

- Device is in the correct location.

Note Observe the ambient conditions and space requirements!

- The power connection of the detector is plugged in.

If the detector is part of a HPLC system, the following must be observed:

- The network connection to the router is established
- The KNAUER chromatography software OpenLAB[®], ChromGate[®] oder ClarityChrom[®] has been installed by KNAUER or a company authorized by KNAUER.
- Capillaries from the column to the UV detector and capillaries from the detector to the waste bottle are securely attached.

Installation of the flow cell



CAUTION!

**Intruding liquids can cause damage to the device!
Place solvent bottles next to the device or in a solvent tray.**

Moisten the cleaning cloth only slightly.

The supply configuration of this detector only includes a test cell from KNAUER, which does not have connections for solvent. It is used, for example, to check the lamp intensity, as a dirty flow cell can distort this value. Before using the device with solvents, a KNAUER flow cell must be installed.

A list of the flow cells that can be used can be found in the chapter "Available flow cells for the Smartline detector 2520"

Legend

- ① Inlet of the flow cell
- ② Layer thickness of the flow cell (10 mm)
- ③ Light path
- ④ Outlet of the flow cell
- ⑤ Knurled-head screws
- ⑥ Cover plate
- ⑦ Carriage

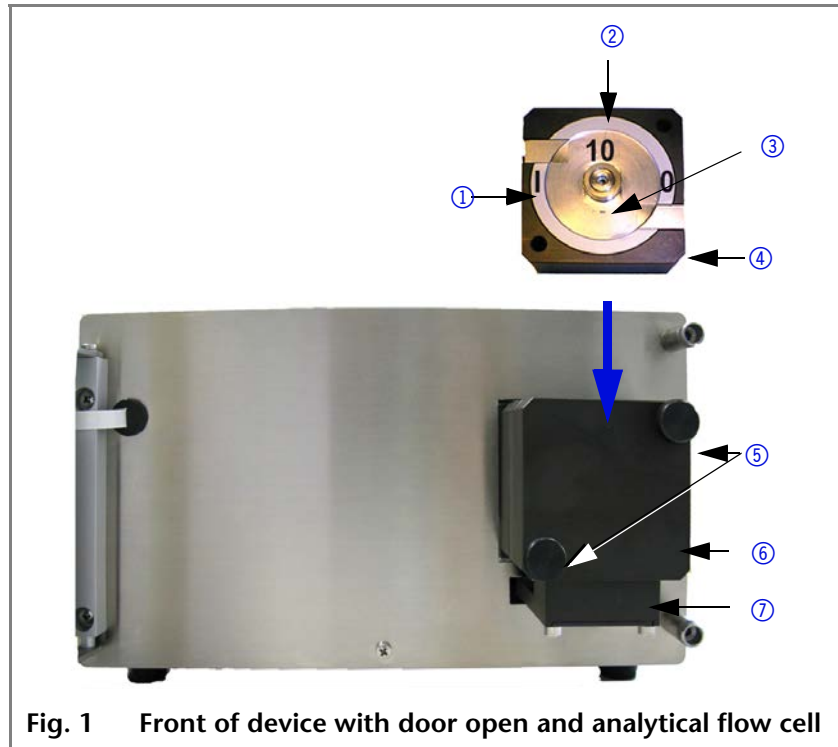

Fig. 1 Front of device with door open and analytical flow cell

Prerequisites

- The device has been switched off.
- The power plug has been pulled.

Procedure for installing the flow cell

1. Open the device door and loosen and remove both knurled-head screws (⑤) by hand.
2. Hold the flow cell securely and pull the carriage (⑦) out towards the front.
3. Lift up and remove the simulation cell located in the carriage with two fingers.
4. Insert the new flow cell in the carriage and ensure that the engraved layer thickness (②), if exist, points towards you and the alignment pin of the detector housing fits into the corresponding hole on the rear of the cell.
5. Push the carriage onto the housing. Insert both screws and tighten manually.
6. Connect the incoming and outgoing capillaries at the inlet (①) and outlet (④) of the flow cell.

Changing the optical path length of a preparative flow cell

At delivery, the optical path length of a preparative flow cell is set to 2 mm at the factory. This path length can be set to 2, 1.25 or 0.5 mm, however. To reduce it to 1.25 or 0.5, proceed as follows:

This description applies for the preparative flow cells with order numbers A4066, A4067 and A4068 with 1/8" or 1/4" connections.

Legend

- ① Threaded ring
- ② Stainless steel cover
- ③ PEEK spacer
- ④ Seal holder (compression bushing)
- ⑤ Fiber optics with PTFE seal

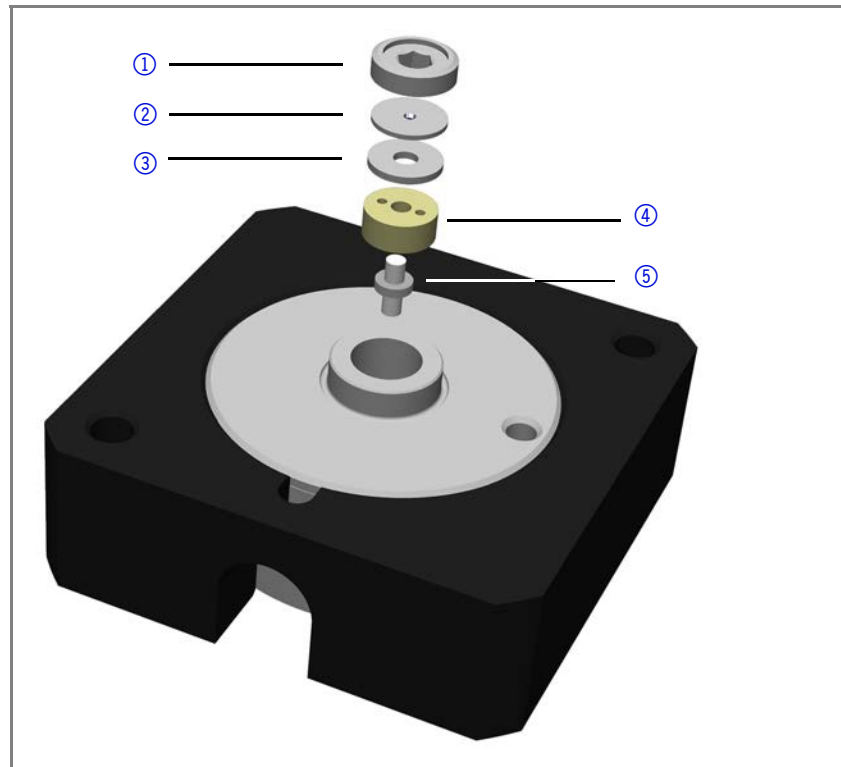

Procedure for shortening the optical path length

1. Loosen the threaded ring with a hexagonal spanner.
2. Remove stainless steel cover and the PEEK spacer.
3. Insert the stainless steel cover again and tighten the threaded ring again.

The missing spacer causes the fiber optics to be pushed deeper into the flow cell (0.75 mm), resulting in a shortened optical path length of 1.25 mm. To further shorten down to 0.5 mm, the PEEK spacer on the other cell side must also be removed.

Procedure for lengthening the optical path length

To increase the optical path length in steps of 0.75 mm, put the spacers back in.

1. Loosen the threaded ring with a hexagonal spanner.
2. Remove stainless steel cover and fiber optics together with the seal holder with tweezers.
3. To enlarge the path length, push the fiber optics out approximately 1 mm. Please use a clean cloth and avoid touching the fiber optics with your fingers.
4. Put the fiber optics together with the seal holder back into the cell.
5. Insert the PEEK spacer and then the stainless steel cover.
6. Tighten the threaded ring again.

When tightening the threaded ring, the rod-shaped fiber optics is pushed into the correct position in the cell. Inserting a spacer lengthens the optical path length by 0.75 mm. When changing the path length, the PTFE seal does not need to be changed.

Connecting the detector to other devices

Electrical connections

The detector is connected with the *Events and remote control* terminal strip and within a network with the LAN connection to external devices. A computer can also be connected to the detector using the RS-232 interface.

Connecting the connector strip with the cable

To connect external devices to the detector, the corresponding cables are connected with a connector strip and connected to the *Event and remote control* terminal strip on the rear of the detector.



CAUTION!
Electrostatic discharge can destroy the electronics!
Wear protective bracelet against electrostatic discharge and ground.

Connection, connector strip with cable

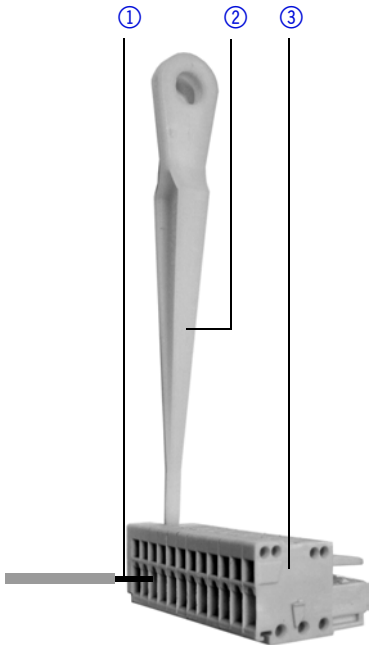
Procedure	Figure
<ol style="list-style-type: none"> 1. Place the connector strip (③) on a suitable surface. 2. Press down the cable terminal with the stylus (②). 3. Keep the stylus pressed down and stripped insert the cable ends (①) into the front of the connector strip. 4. Remove stylus. 5. Check whether the cables are tightly attached. 	 <p data-bbox="995 1709 1374 1798">Fig. 2 Connect the connector strip with the cable</p>

Terminal strip *Event and remote control* on the rear of the device

The electric terminal strip *Event and remote control* is used to exchange signals with other devices.

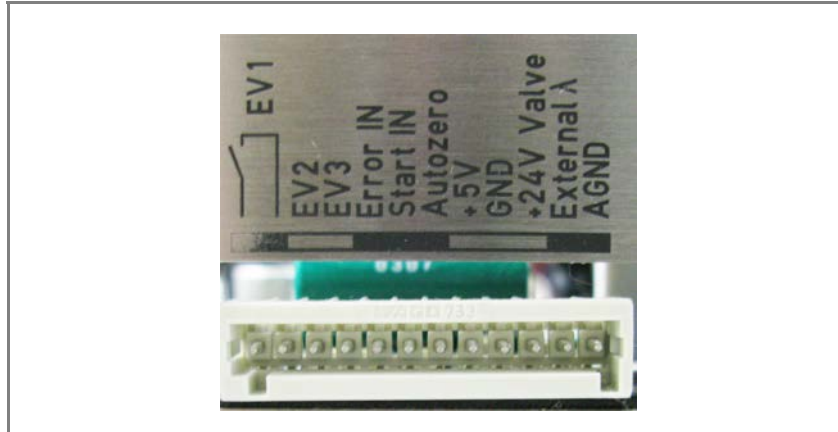





Fig. 3 Terminal strip *Event and remote control*

Signal	Explanation
 EV 1	Relay contact Relay dropped out0 Relay actuated1 Pulse: (relay actuated for 1000 ms)  Permissible load of the relay contact: 1 A/30 V
EV 2	TTL output Possible levels: Low (<500 mV)0 High (>2 V)1 Pulse (>2 V for 1000 ms)  To ensure secure operation, the load resistance of the output may not drop below 10 kΩ.
EV 3	See EV 2
ERROR: IN	TTL input When an error signal is received, running programs are terminated and the message Error input activated appears.
START: IN	TTL input When a signal is received, a program is started in HOLD mode or a link with the corresponding WAIT parameter is started.
AUTOZERO	The current measurement signal is set to zero.

Signal	Explanation
+5 V	Provides a voltage of 5 V with respect to GND. This makes it possible to supply a consumer switched with event 1 (relay). The output is protected with an internal 62 mA fuse.
GND	Reference point for the TTL level
+24 V valve	Event-controlled switching of 24 V against GND. The output is protected with an internal 250 mA fuse. This output can be used for direct operation of a fraction valve.
External λ	Allows external analog control of the detector when the option ANALOG has been selected in the SETUP menu. The control voltage must be applied against AGND.
AGND	Reference point of the voltage at the input External λ .

Manual configuration of the control signals (events)

In the program menu, the events E-1 and E-2 can be activated directly and independent of one another. Here it is relevant for the behavior whether or not E-1 or E-2 has been selected as control event in the FRACTION menu (see Setup menu).

Procedure

1. Open the Program menu.
2. Select the program number.
3. Press horizontal arrow key to go to the editing mode of the submenu.

Enter values for *events* in the upper status bar, by using the vertical arrow keys.

If none of the two events is used for fractionation, they have the following meaning:

Value	Explanation
0	Event output remains in off state (off).
1	Event output is switched.
	The output is switched on for 1 second and then off again.
-	No status change.

If one of the two events is used for fractionation, then the behavior of the corresponding event fields in the main menu changes.

Value	Explanation
0	If the threshold is exceeded for fractionation, this setting prevents an event from being triggered.
1	When the threshold for fractionation is exceeded, the assigned event switching is triggered.
∏	Has no meaning in this case

Control of the detector with chromatography software

The detector can be controlled within an LC system with a computer and the KNAUER chromatography software ChromGate® or ClarityChrom®.

Network connection

The computer is connected via the LAN network connection or the serial interface (RS-232 interface) on the rear of the detector. If the detector is controlled with software, this is indicated in the display by a  symbol.

For operation of the Smartline detector 2520 using ChromGate or ClarityChrom, no special settings are necessary on the detector.

Connecting to a local area network (LAN)

This chapter describes how to set up an HPLC system in a local area network (LAN) and how a network administrator can integrate this LAN into your company network. The description applies to the operating system Windows® and all conventional routers.

Note To set up a LAN, we recommend to use a router. That means the following steps are required:

- Process**
1. On the computer, go to the control panel and check the LAN properties.
 2. Hook up the router to the devices and the computer.
 3. On the computer, configure the router to set up the network.
 4. Install the chromatography software from the data storage device.
 5. Switch on the device and run the chromatography software.

Configuring the LAN Settings

The LAN uses only one server (which is normally the router) from that the devices automatically receive their IP address.

- Prerequisite**
- In Windows®, power saving, hibernation, standby, and screen saver must be deactivated.
 - In case you use an USB-to-COM box, the option "Allow the computer to turn off this device to save power" in the device-manager must be deactivated for all USB hosts.
 - Only for Windows 7: For the network adapter, the option "Allow the computer to turn off this device to save power" in the Device Manager must be deactivated.

- Procedure**
1. In Windows 7 choose *Start ⇒ Control Panel ⇒ Network and Sharing Center*.
 2. Double-click on *LAN Connection*.
 3. Click on the button *Properties*.
 4. Select *Internet Protocol version 4 (TCP/IPv4)*.
 5. Click on the button *Properties*.
 6. Check the settings in the tab *General*. The correct settings for the DHCP client are:
 - a) *Obtain IP address automatically*
 - b) *Obtain DNS server address automatically*
 7. Click on the button *OK*.

Connecting the Cables

A router has several LAN ports and one WAN port that can be used to integrate the LAN into a wide area network (WAN), e.g. a company network or the Internet. In contrast, the LAN ports serve to set up a network from devices and a computer. To avoid interference, we recommend operating the HPLC system separately from the company network.

You will find patch cables for each device and the router in the accessories kit. To connect the router to a WAN, an additional patch cable is required, which is not supplied within the scope of delivery.

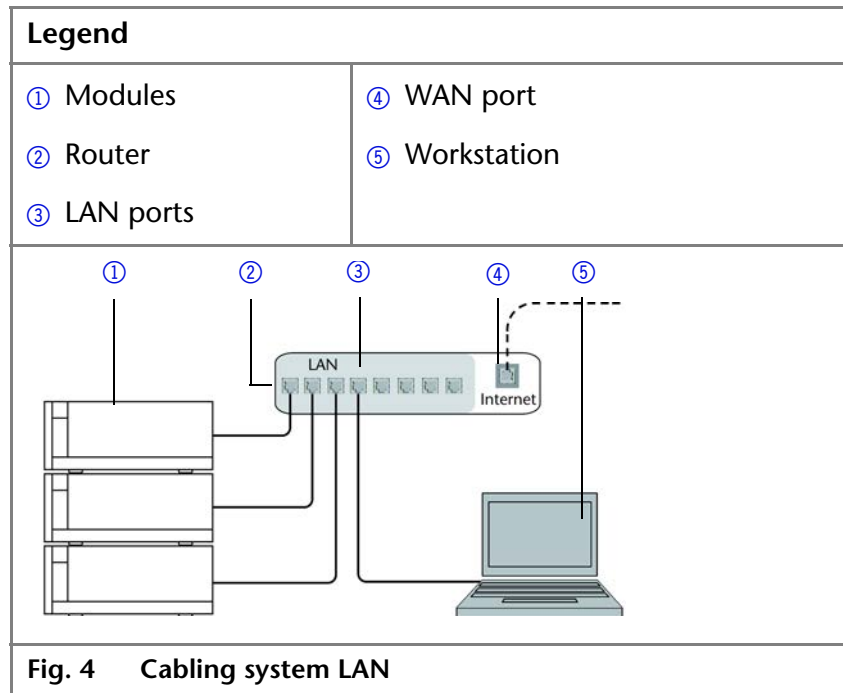

Fig. 4 Cabling system LAN

- Prerequisite**
- The computer has been switched off.
 - There is a patch cable for each device and the computer.

- Procedure**
1. Use the patch cable to connect the router and the computer. Repeat this step to connect all devices.
 2. Use the power supply to connect the router to the mains power system.

Configuring the Router

The router is preset at the factory. You will find a label at the bottom side of the router, on which IP address, user name, and password are printed. These information help to open the router configuration.

- Procedure**
1. To open the router configuration, start your Internet browser and enter the IP address (not for all routers).
 2. Enter user name and password.
 3. Configure the router as DHCP server.
 4. In the router configuration, check the IP address range and make changes if necessary.

Result Once the router has assigned IP addresses to all devices, the chromatography software can be used to remotely control the system.

Integrating the LAN into a Company Network

A network administrator can integrate the LAN into your company network. In this case you use the WAN port of the router.

Prerequisite There is a patch cable for the connection.

- Procedure**
1. Check that the IP address range of the router and of the company network do not overlap.
 2. In case of an overlap, change the IP address range of the router.
 3. Use the patch cable to connect the router WAN port to the company network.
 4. Restart all devices, including the computer.

Controlling Several Systems Separately in a LAN

Devices connected to a LAN communicate through ports, which are part of the IP address. If more than one HPLC system is connected to the same LAN and you plan on controlling them separately, you can use different ports to avoid interference.

Therefore, the port number for each device must be changed and this same number must be entered into the device configuration of the chromatography software. We recommend to use the same port number for all devices in the same system.

Note The port is set to 10001 at the factory. You must use the same numbers in the device configuration of the chromatography software as in the device, otherwise the connection fails.

- Procedure**
1. Find out port number and change it on the device.
 2. Enter the port number in the chromatography software.

Result The connection is established.

Controlling the detector

Switching the detector on

After the device has been switched on with the power switch on the rear, the device name and, with a delay, the firmware version number appear on the display. The device performs a self-test, which concludes with the message **SYSTEM TEST OK**. The same procedure takes place when the device is switched on from standby mode.

The D₂ lamp then preheats for ignition. This is indicated by **INI** in the lower left of the display. The start routine is completed with an automatic device calibration, which is displayed with **Calibrating...** After this, **ON** appears in the display. The basic settings are similar to those before switching the detector off. The device is now ready for use.

Legend

- ① Display: Program/Link
- ② Event status
- ③ Signal output display
- ④ Arrow key
- ⑤ Standby key
- ⑥ Wavelength display
- ⑦ Number key
- ⑧ Time display
- ⑨ Status of program/link
- ⑩ *AUTO ZERO* key

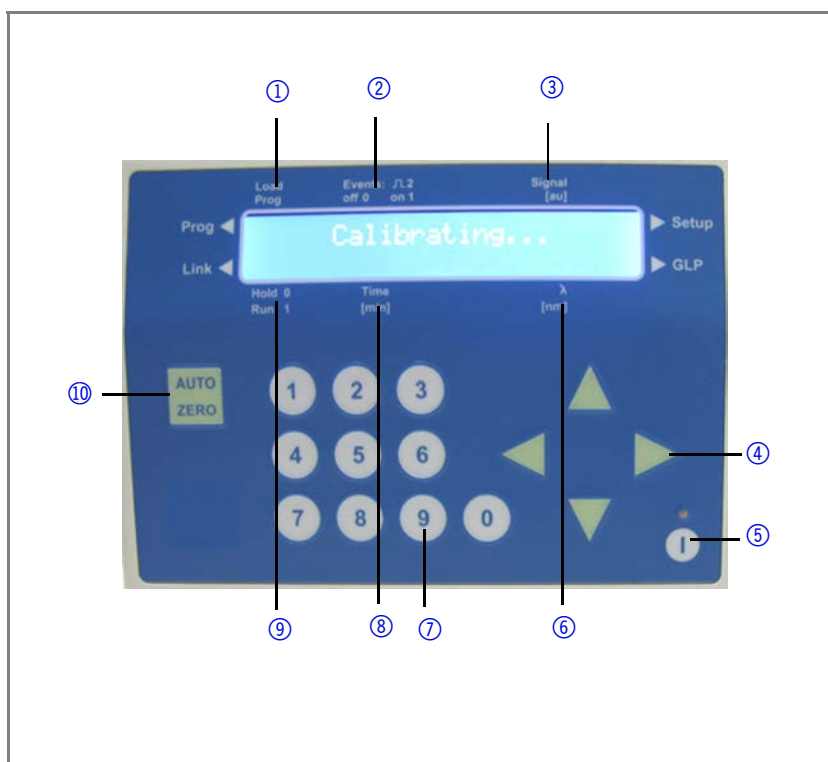

Procedure for switching the device on

1. Switch the detector on with the power switch on the rear of the device. The device name is displayed followed by the firmware version number.
2. Wait until the detector has performed the system test. This is indicated with the message **SYSTEM TEST OK**.
3. Wait until deuterium lamp has preheated. The preheating is indicated by **INI** in the lower left of the display.
4. Wait until the device calibration is completed. **ON** then appears in the display.

Selecting the wavelength

Note You can set a wavelength between 190-750 nm.

Procedure for selecting the wavelength

1. Using the arrow keys, position the cursor in the field for the wavelength (⑥).
2. Enter the desired value using the number keys or using the vertical arrow keys.
3. Confirm entry by using the horizontal arrow keys. Otherwise, the display will return to the previous value after five seconds.

Two spectral edge filters to suppress the second diffraction order are automatically activated if a deuterium lamp is installed and the shortest wavelength in all active channels exceeds an internal default value. The activated filter is indicated by the raised + in front of the specification of the wavelength.

The output of measurement can be inverted:

1. Position the cursor in the signal output field (③).
2. Use the vertical arrow keys to invert the signal ("-" symbol).

Controlling the main menu

The normal display after switching the device on shows the last set operating mode. The flashing cursor is in the lower left corner of the display. The last loaded program or link is shown in the upper left. Time, event setting and wavelength correspond to the first line of the loaded program. All fields that do not contain active elements are replaced with the "-" character.

Navigation through the main menu

- Use the horizontal arrow keys to navigate through the two lines of the display of the main menu.
- With the number keys, you can increase or decrease the number values.

Practical tip!

With the vertical arrow keys, you can increase or decrease the displayed values.

During navigation through the main menu, the cursor is a flashing rectangle at the current position. During entry, the cursor turns into the underscore character.

Procedure for entering values

1. Use the horizontal arrow keys to put the cursor at the desired position in the display.
2. Use the number keys or the vertical arrow keys to enter a desired value.

Input mode is automatically terminated without saving the entered values if no key is pressed for 5 seconds.

Legend

- ① Setup menu
- ② GLP menu
- ③ Link menu
- ④ Program menu

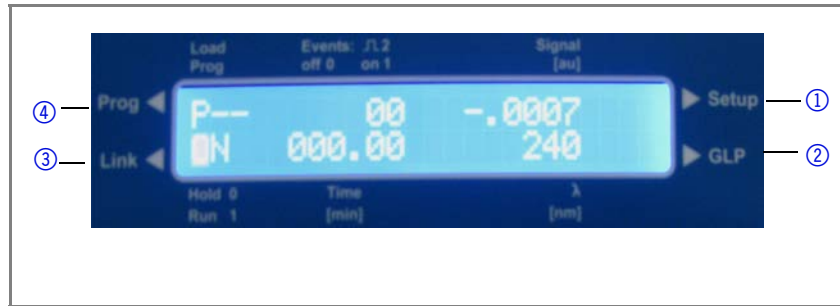

Selecting the Setup menu

- Procedure**
1. Use the horizontal arrow keys to put the cursor in the top line of the display.
 2. Press the right horizontal arrow key for approx. 1 second.
 3. Press *AUTO ZERO* or hold one of the horizontal arrow keys for approx. 1 second to return to the main menu.

Selecting the GLP menu

- Procedure**
1. Use the horizontal arrow keys to put the cursor in the lower line of the display.
 2. Press the right horizontal arrow key for approx. 1 second.
 3. Press *AUTO ZERO* or hold the horizontal arrow key for approx. 1 second to return to the main menu.

Selecting the Link menu

- Procedure**
1. Use the horizontal arrow keys to put the cursor in the lower line of the display.
 2. Press the left horizontal arrow key for approx. 1 second.
 3. Press *AUTO ZERO* or hold the horizontal arrow key for approx. 1 second to return to the main menu.

Selecting the Program menu

- Procedure**
1. Use the horizontal arrow keys to put the cursor in the top line of the display.
 2. Press the left horizontal arrow key for approx. 1 second.
 3. Press *AUTO ZERO* or hold the horizontal arrow key for approx. 1 second to return to the main menu.

Controlling the Setup menu

In the SETUP menu, fundamental parameters for controlling the detector are specified.

Navigating through the Setup menu

- Use the horizontal arrow keys to navigate through the two lines of the display.
- Move the cursor onto the diamond icon to navigate through the subitems of the Setup menu by means of the vertical arrow keys.

Practical tip!

With the vertical arrow keys, you can increase or decrease the number values.

Increase or decrease number values

1. Use the horizontal arrow keys to put the cursor at the desired position in the display.
2. Use the number keys to enter a desired value.
3. Use the vertical arrow keys to select the option.
4. Move the cursor onto the diamond icon to navigate through the further subitems of the Setup menu by means of the vertical arrow keys.
5. Press *AUTO ZERO* or hold the horizontal arrow key for approx. 1 second to return to the main menu.

Structure of the Setup menu

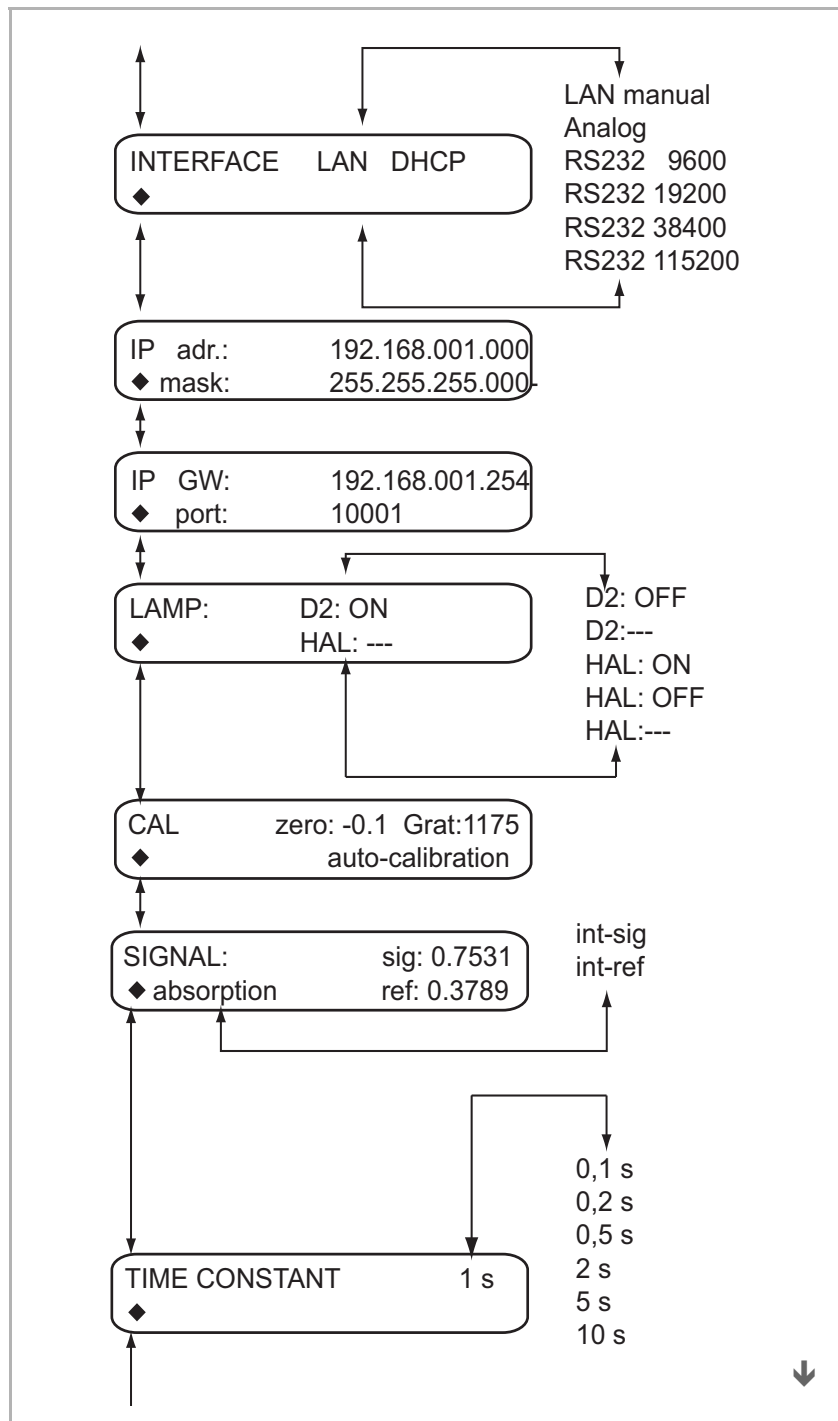

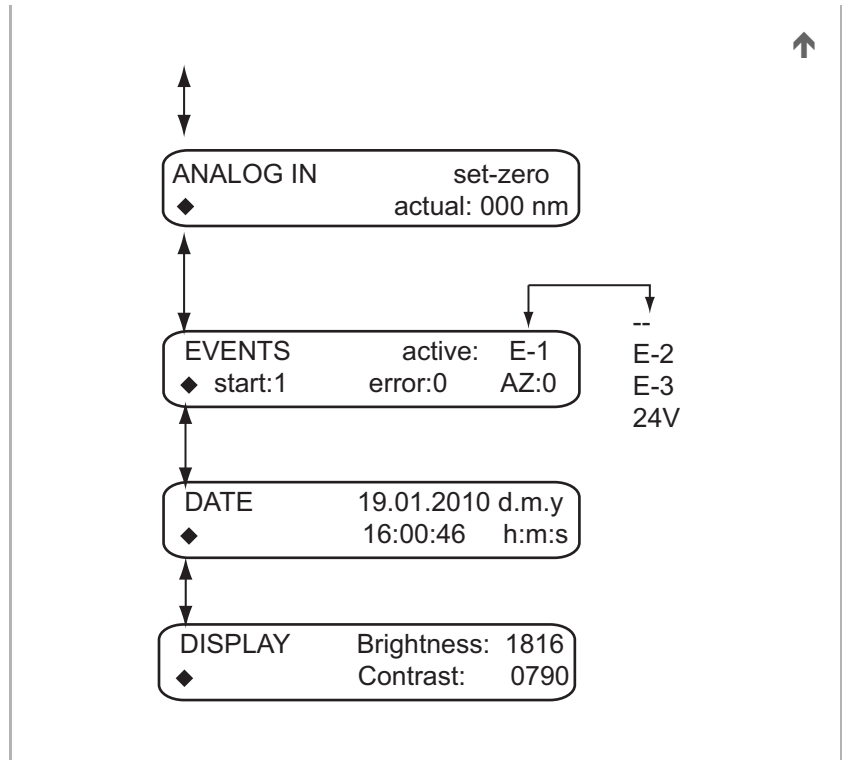

Fig. 5 Structure of the Setup menu

Parameters of the Setup menu

Value	Meaning
INTERFACE	Setting of the connection options of the detector. Connections on the rear of the device.
IP adr:/mask:	Setting of the IP address and the subnet mask.
IP GW:/Port:	Setting of the gateway and the port.
LAMP	Setting of the lamp configuration (deuterium). A source that is not installed is indicated by ---.
CAL	<p>Display of the effective line density of the optical grating in lines/mm and offset of the unbent light. Necessary for automatic wavelength accuracy and correction thereof. Manual setting not necessary, automatic calibration is started with the vertical arrow keys and initiates a complete calibration procedure.</p> <p>Note: It is recommended that after each change of the flow cell or solvent, an auto calibration should be performed to optimally adjust the detector properties. When doing so, make sure that the flow cell is completely filled with solvent and free of air bubbles.</p>
SIGNAL	Selection of the signal source that will be used for all outputs. Selection between absorption , int-sig (signal channel) and int-ref (reference channel).
TIME CONSTANT	Selection of a time constant to be used for signal smoothing. The larger the value of the selected time constant, the stronger the applied signal smoothing. The surfaces of the elution peaks remain, their profile can however be changed in particular with long time constants.
ANALOG OUT	<p>Here the offset (moving the baseline) and scaling (in AU/V) of the integrator output can be set. Any negative signals must be made viewable with an offset as the analog outputs cannot provide a negative voltage.</p> <p>If int-sig or int-ref is selected as data source, the scaling unit is 1/V.</p>

Value	Meaning
ANALOG IN	Option for calibrating the analog input of the terminal strip for an external wavelength control. Using the vertical arrow keys in the set-zero field, it is possible to define an applied input voltage as spectral zero point with a wavelength of 000 nm. If a different positive control voltage is applied, the current "λ" field displays a resulting wavelength with scaling of 100 nm/V. This wavelength can then be adjusted finely by using the vertical arrow keys. Thus a second calibration point is generated, which modifies the scaling. Note: With respect to the maximum linearity, it is recommended to scale the input voltage to 100 nm/V. The longest accessible wavelength (750 nm) corresponds thus to a control voltage of 7.5 V.
EVENTS	Used for testing the terminal strip functions. The connections E-1 to E-3 and the 24 V output can be selected, which can be activated individually.
DATE	Setting of the time and date. Day, month, year, hour, minute and second are set independently of one another.
DISPLAY	Here the brightness and contrast of the display can be set.

Controlling the GLP menu

All displays of the GLP menu are for information purposes only. They provide information about the use of the detector as well as an overview of the configuration and condition of the device. Entries are not possible.

Navigating through the GLP menu

- A diamond icon is displayed on the left of the lower line in the display. Move the cursor onto the diamond icon to navigate through the subitems of the GLP menu by means of the vertical arrow keys.
- Press *AUTO ZERO* or hold the horizontal arrow key for approx. 1 second to go to the main menu.

Structure of the GLP menu

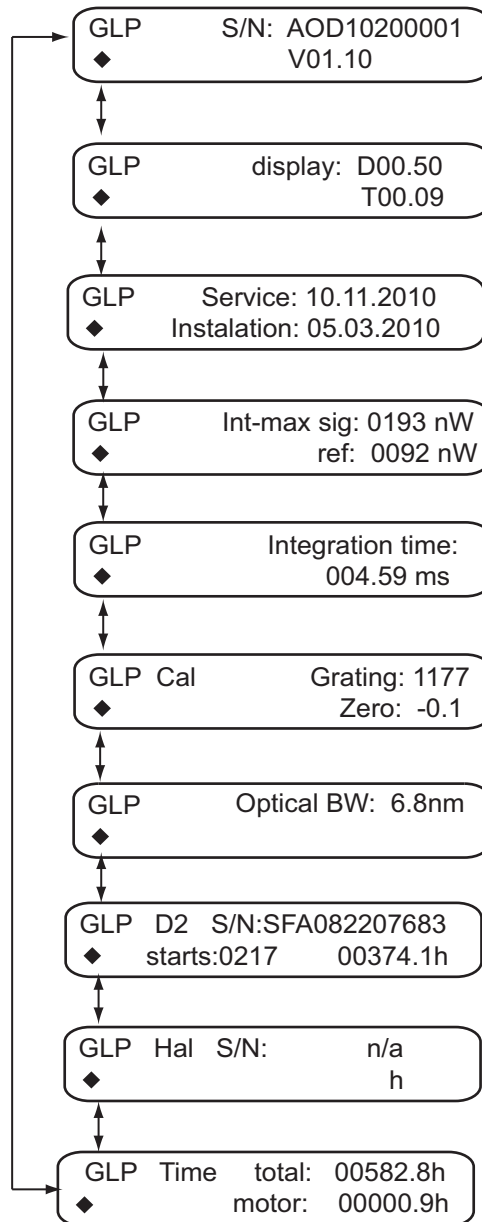

Fig. 6 Structure of the GLP menu

Parameters of the GLP menu

Value	Meaning
GLP S/N	Display of the serial number and the currently installed firmware version.
GLP display	Display of the firmware version.
GLP Service Installation	Display of the initial installation and last service.
GLP Int-max	Display of the maximum light output in the measurement and reference channel. This specification serves mainly to evaluate the lamp aging. This value is determined during device calibration and thus does not change during the work phase of the detector but only when calibration is performed again.
GLP Integration time	Display of the optimal integration time of the detector, which is automatically determined during calibration. The value is dependent on the status of the lamp and the flow cell that is used.
GLP Cal	Display of the line density of the optical grating as well as the fine deviation of the zeroth spectral order. Both values are used for exact positioning on the selected wavelength.
GLP optical BW	Display of the results of the self-test for optical bandwidth.
GLP D2 GLP Hal	Display of the serial numbers of the installed lamps, their operating time and, in case of the deuterium lamp, also the number of lamp starts. If a source is not installed, it is indicated by ---.
GLP time	Display of the total operating time of the detector and the run time of the grating motor. The grating motor operating times are only registered when the device operates in multiple channel mode.

Controlling the Program menu

The Program menu is used to list and create programs.

The Smartline detector 2520 can save up to 19 programs and up to 99 program lines. Program 20 is reserved for a special wake-up program for a time-delayed execution of the links or programs. Max. 10 program links between defined programs can be created and saved.

Programs can be created for the following functions:

- Specification or modification of the wavelengths
- Definition of signal events during a wavelength program

Creating a program

- Procedure**
1. Select the Program menu.
 2. Select the program number.
 3. Press horizontal arrow key to go to the editing mode of the submenu.
 4. Enter desired values.
 5. To specify the desired start time in the submenu, position the cursor on the diamond icon and press the vertical arrow keys.
 6. Press *AUTO ZERO* key to return to the main menu.

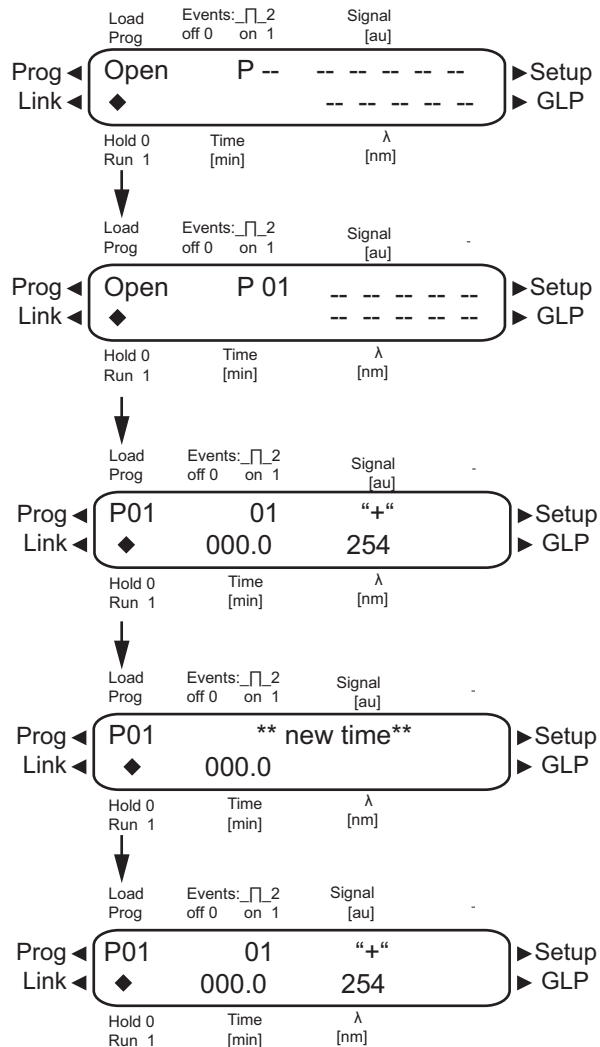

Fig. 7 Creating a program

Running a program

Before a program is run, it must be loaded.

- Procedure**
1. Select the Program menu.
 2. Select the program number.
 3. Press horizontal arrow key to go to the editing mode of the submenu.
 4. Press *AUTO ZERO* key to go to *ON/OFF* mode.
 5. Enter the program number and confirm with the horizontal arrow key. The display switches to *HOLD* mode.
 6. Place the cursor onto *HOLD* and press *1*. The display switches to *RUN* mode (program is running).
 7. After the program has been completed, press *AUTO ZERO*. The display switches to *ON/OFF* mode.

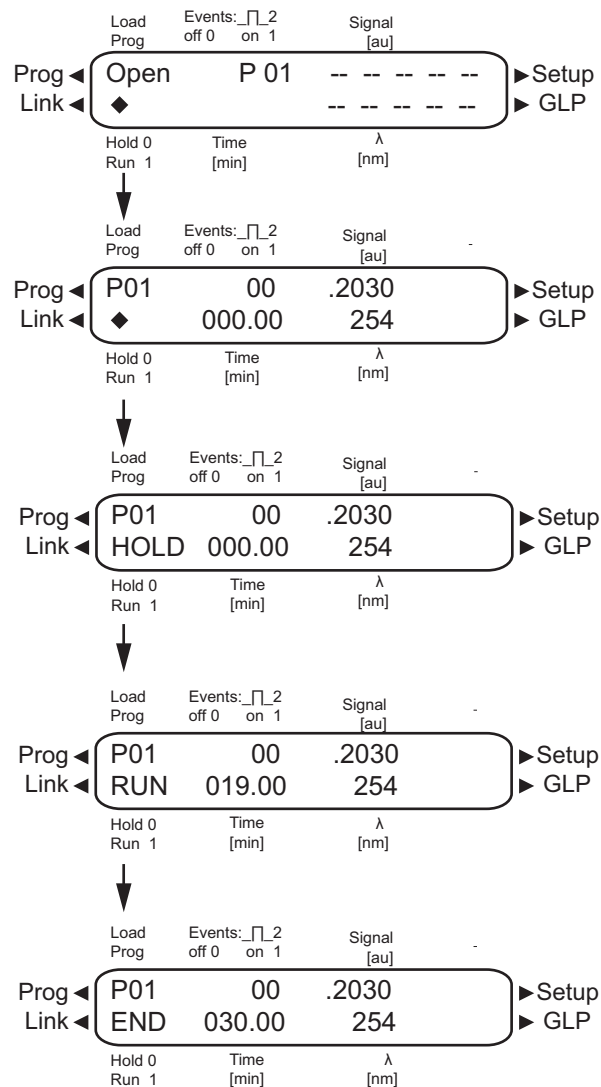

Fig. 8 Running a program

Changing a program

When values are entered, the old values are overwritten.

- Procedure**
1. Select the Program menu.
 2. Select the program number.
 3. Press horizontal arrow key to go to the editing mode of the submenu.
 4. Using the vertical arrow keys, navigate to the program line that is to be changed.
 5. Enter the desired value.
 6. Position cursor on the diamond icon and hold the horizontal arrow key down to exit the submenu.

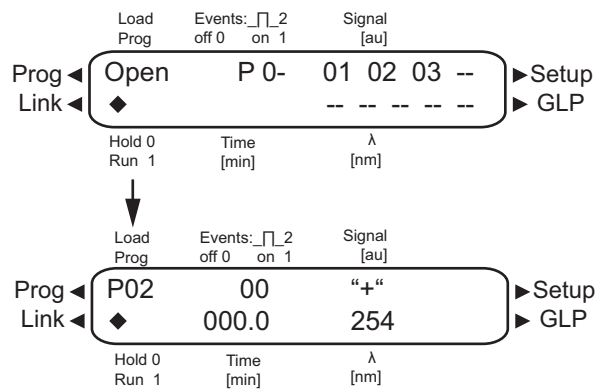

Fig. 9 Changing a program

Deleting a program

- Procedure**
1. Select the Program menu.
 2. Enter program number 0.
 3. Press horizontal arrow key to go to the editing mode of the submenu.
 4. Enter number of the program to be deleted.
 5. Press vertical arrow key to confirm.

Note Running programs and programs which are contained in a running link cannot be deleted.

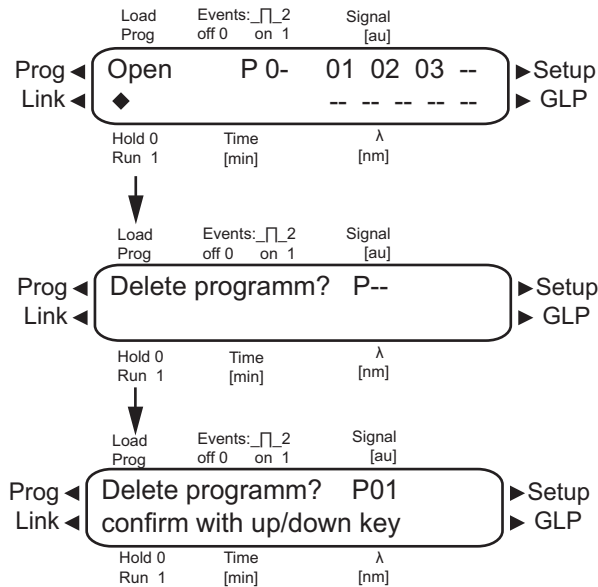

Fig. 10 Deleting a program

Creating a program with preselectable start time

Program number 20 serves as a wake-up program. Here a program or link can be loaded at a prescribed time. The device is switched on from standby mode at the desired time, the D_2 sources is ignited and put into the so-called *HOLD* state.

Note Make sure that the date and time configured in the Setup menu are correct.

- Procedure**
1. Select the Program menu.
 2. Enter program number 20.
 3. Press horizontal arrow key to go to the editing mode of the submenu.
 4. Enter the date and time for the program start.
 5. Enter the number of the program that should start at the pre-set time.

To interrupt the current *WAKE UP* program, enter another program number.

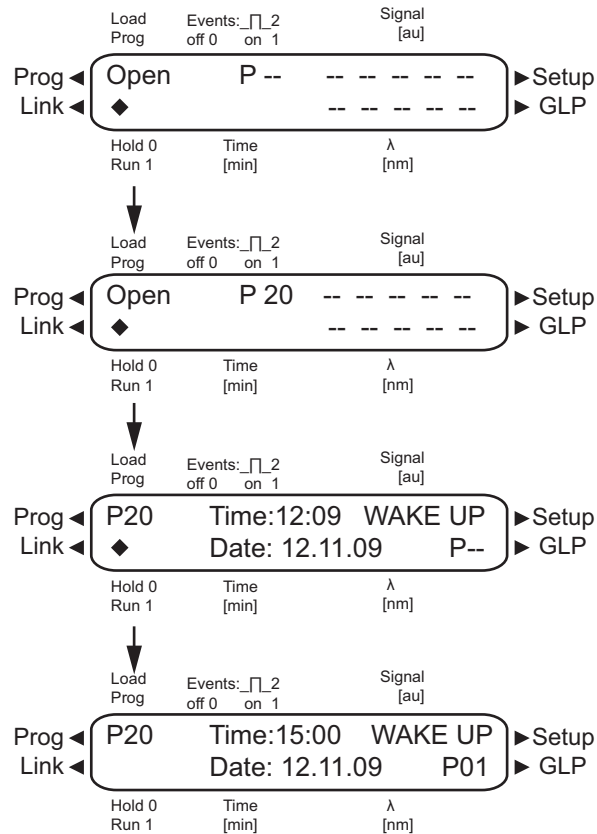

Fig. 11 Creating a wakeup program

Controlling the Link menu

Links are references between existing programs, which can be defined and edited, like the programs themselves.

Links are created and listed in the Link menu.

Navigating through the Link menu

Use the horizontal arrow keys to navigate through the two lines of the display. A diamond icon is displayed on the left of the lower line. Move the cursor onto the diamond icon to navigate through the subitems of the Link menu by means of the vertical arrow keys.

With the vertical arrow keys, you can increase or decrease the number values by one value.

Increase or decrease number values

1. Use the horizontal arrow keys to move the cursor to the desired position in the display.
2. Use the number keys to enter a desired value.
3. Move the cursor onto the diamond icon to navigate through the further subitems of the Link menu by means of the vertical arrow keys.
4. Press *AUTO ZERO* key or hold the horizontal arrow key for approx. 1 second to return to the main menu.

Creating a link

A maximum of ten links between defined programs can be created and saved.

Every link contains a program number **P** (01–19), a number **R** for repetitions (1–99) and a programmable wait status **W** (0 or 1).

- Procedure**
1. Select the Link menu.
 2. Enter the link number.
 3. Press horizontal arrow key to go to the editing mode of the submenu.
 4. Move the cursor to position *P* in the display and enter the program number.
 5. Move the cursor to position *R* (*R* = Repeat) and enter the value (number of repetitions for the specified program).
 6. Move the cursor to position *W* in the display and enter 1 or 0.

Note If the **W 0** (*W* = Wait) setting is used, the detector waits for an external start signal or for the user to press number 1 (run). Every subsequent line starts immediately. If the **W 1** setting is used, the link sequence is run without interruption.

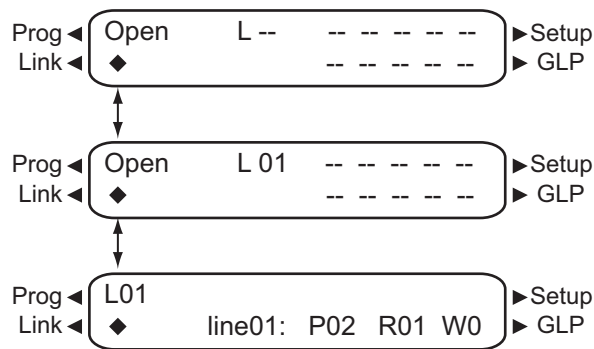

Fig. 12 Creating a link

Executing a link

After the link has been executed, the detector stops. The display switches to the *END* mode.

- Procedure**
1. Select the Link menu.
 2. Enter the link number.
 3. Press horizontal arrow key to go to the editing mode of the submenu.
 4. Press *AUTO ZERO* to go to *ON/OFF* mode.
 5. Enter the link number.

6. Press number 1. The display switches to *HOLD* mode.
7. Press number 1 again. The display switches to *RUN* mode (linked program is running).
8. After the link has been completed, press *AUTO ZERO*. The display switches to *ON/OFF* mode.

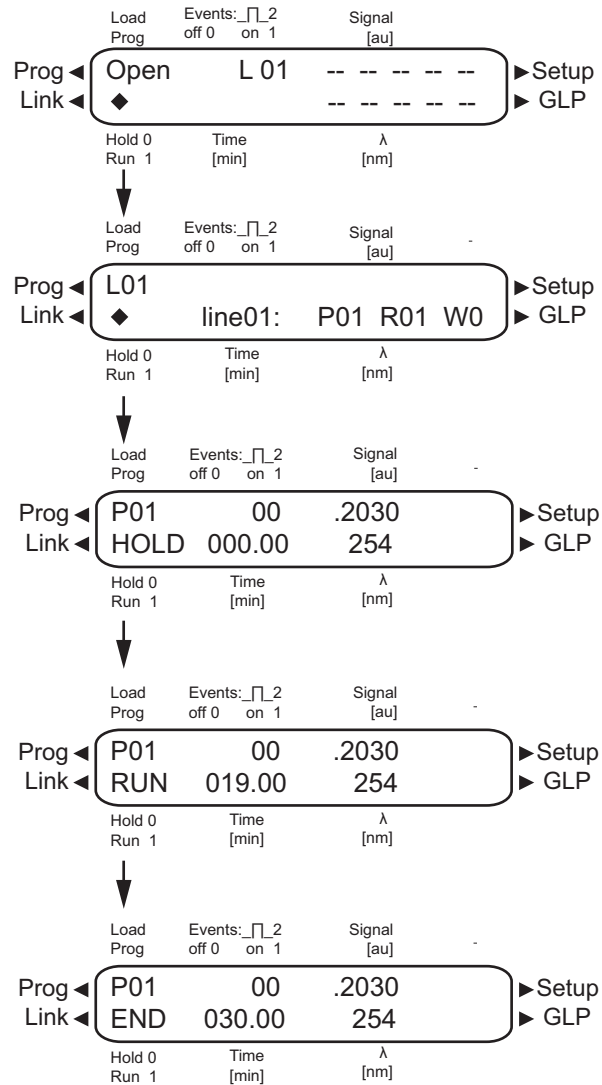

Fig. 13 Executing a link

Deleting a link

- Procedure**
1. Select the Link menu.
 2. Enter link number 0.
 3. Press horizontal arrow key to go to the editing mode of the submenu.
 4. Enter number of the link to be deleted.
 5. Press vertical arrow key to confirm.

Note Running links cannot be deleted.

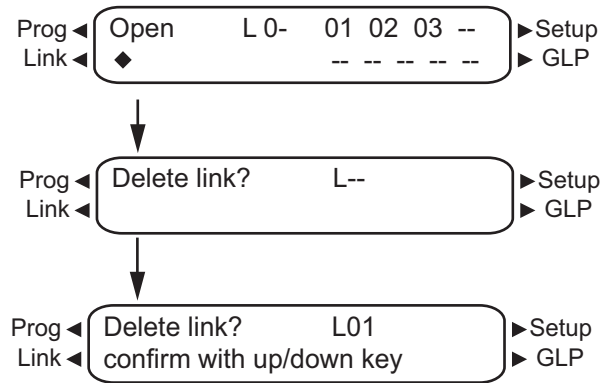

Fig. 14 Deleting a link

Maintenance and care

Organic solvents are toxic above a certain concentration. Ensure that work areas are always well-ventilated! When performing maintenance tasks on the device, always wear safety glasses with side protection, protective gloves, and an overall.

All wetter components of a device, e. g. flow cells of detectors or pump heads and pressure sensors for pumps, have to be flushed with isopropanol first and water afterwards before being maintained, disassembled or disposed.

**WARNING!**

Irritation of retina through UV light! Concentrated UV light can leak out from the flow cell or the fiber optic connectors.

Switch off the device and pull the power plug.

**CAUTION!**

Performing maintenance tasks on a switched on device can cause damage to the device.

Switch off the device and pull the power plug.

The following maintenance tasks can be performed by users:

- Cleaning the flow cell
- Replacing the flow cell

KNAUER Technical Support

**Contact data for
Technical Support****European hotline**

If you have any technical questions regarding KNAUER hardware or software, please use one of the contact options below:

Languages: German and English

Available by telephone: 8 am to 5 pm (CET)

Phone:+49-(0)30-809727-111

Fax:+49-(0)30-8015010

E-mail: support@knauer.net

Maintenance contract

The following maintenance work on the device may only be performed by KNAUER or a company authorized by KNAUER and is covered by a separate maintenance contract:

- Opening the device or removing housing parts.

Cleaning the flow cell

Increased noise of the base line and reduced sensitivity can be a result of a dirty flow cell.

Often it is sufficient to flush the flow cell to restore optimal sensitivity.

Purging the flow cell

The following solvent is recommended for purging:

- 1 mol/l HCl
- 1 mol/l NaOH
- Ethanol
- Acetone
- Water

- Procedure**
1. Fill one of the recommended solvents into a syringe.
 2. Inject it into the inlet of the flow cell and allow it to act for 5 minutes.
 3. Flush with plenty of water
 4. The cell is then dried in a nitrogen stream.



CAUTION!
Contamination of the flow cell caused by oil drops! Do not use compressed air for drying.

If flushing does not have the desired effect, all flow cells can be disassembled to clean the lens.

Cleaning the lens of an analytical flow cell

This description applies for the analytic flow cells A4061, A4042, A4045 and A4061V2.

- Prerequisite**
- Device has been switched off.
 - Flow cell has been removed.

Legend

- ① PTFE seal ring
- ② Lens
- ③ Lens holder (compression part)
- ④ Threaded ring

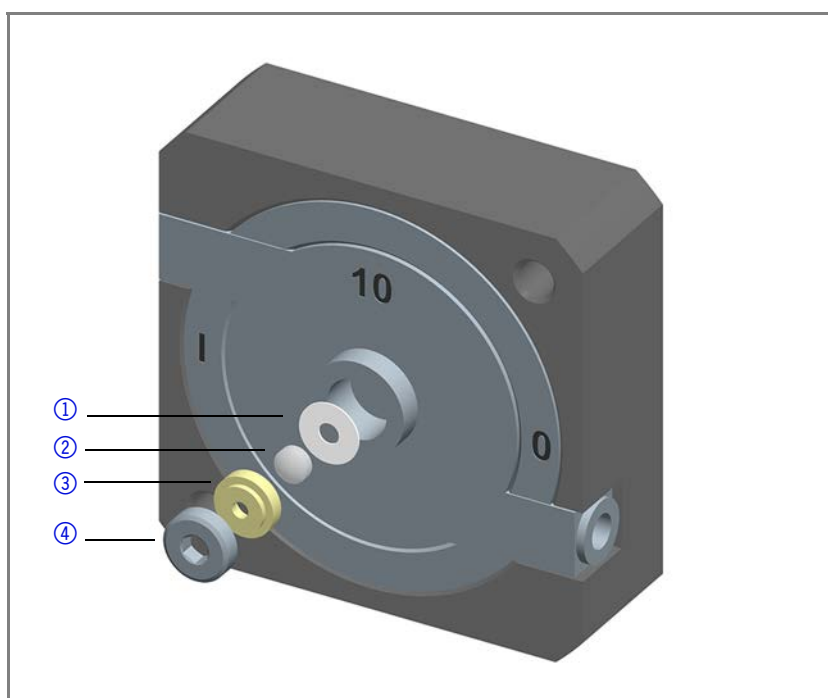

Procedure for cleaning the lens

1. Loosen the threaded ring (④) with the 3 mm hexagonal spanner included with the flow cell.
2. Remove the lens holder (③) with tweezers or by gently tapping and place on a clean surface.
3. The lens (②) is protected by a PTFE seal (①). This must be renewed every time the lens is disassembled.
4. Remove the lens and clean with a clean, soft cloth or with an appropriate solvent in an ultrasonic bath. Ensure that the clean lens is not touched by fingers.
5. Then place the flow cell back and ensure that the new PTFE seal does not interrupt the light path.
6. Next, tighten the threaded ring with the hexagonal spanner in such a manner that damage to the lens is avoided.

Cleaning the fiber optics of a preparative flow cell

This description applies for the preparative flow cells A4066, A4067, A4068 and A4069.

The preparative flow cells have a rod-shaped fiber optic instead of the concave lens of the analytic cells.

Prerequisite

- Device has been switched off.
- Flow cell has been removed.

Legend

- ① Threaded ring
- ② Stainless steel cover
- ③ PEEK spacer
- ④ Seal holder (compression bushing)
- ⑤ fiber optics with PTFE seal

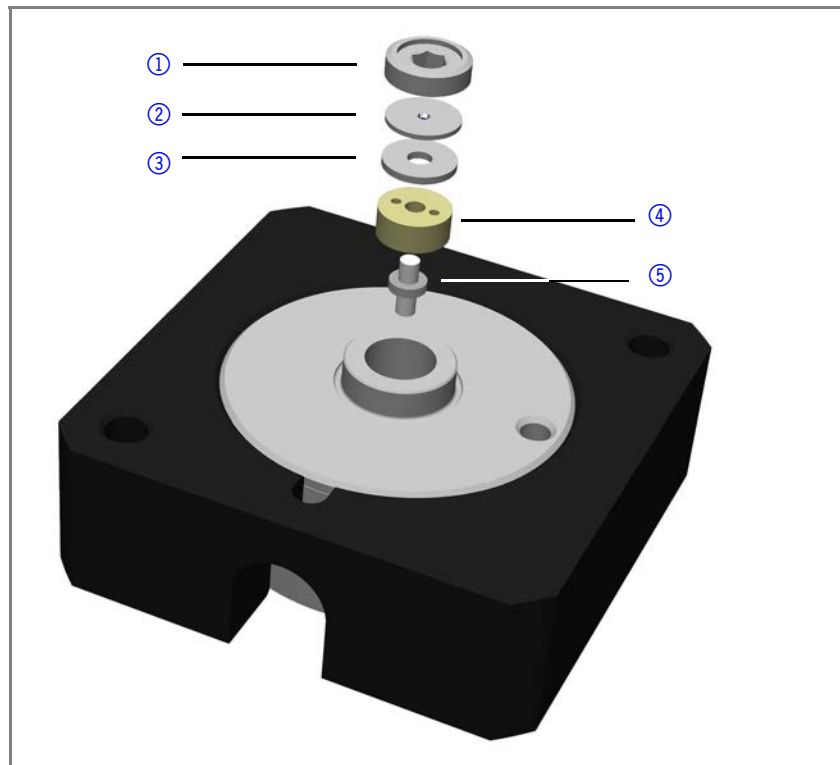

Procedure for cleaning the fiber optics

1. Loosen the threaded ring with the 3 mm hexagonal spanner included with the flow cell.

2. Remove stainless steel cover and the PEEK spacer (not part of A4069).
3. Using tweezers, remove the holder with the fiber optics.
4. Carefully push the fiber optics out of the holder and wipe off the PTFE seal. The PTFE seal must be renewed every time the fiber optics are cleaned.
5. Clean the fiber optics with a clean, soft cloth or with an appropriate solvent in an ultrasonic bath. Ensure that the clean fiber optics are not touched by fingers.
6. Then place the flow cell back and ensure that the new PTFE seal does not interrupt the light path.
7. Next, tighten the threaded ring with the hexagonal spanner in such a manner that damage to the lens is avoided..

Result The fiber optics have been cleaned and put back into the flow cell.

Replacing the flow cell

UV light will cause the flow cells to become blind with time (solarization), making them no longer suitable for use. KNAUER recommends exchanging the flow cell after about 6000 operating hours.

A list of the flow cells that can be used can be found in the chapter "Available flow cells for the Smartline detector 2520".

Legend

- ① Inlet of the flow cell
- ② Outlet of the flow cell
- ③ Knurled-head screws
- ④ Cover plate
- ⑤ Carriage

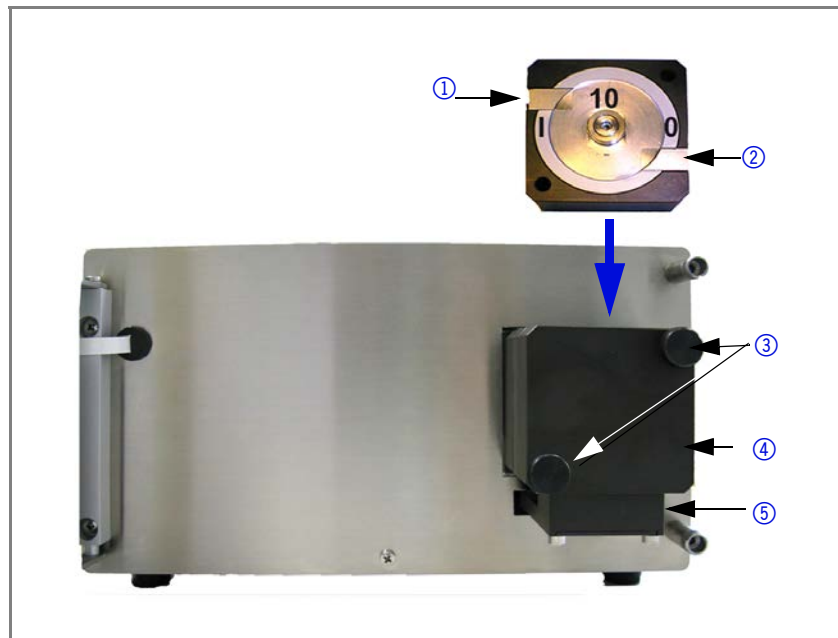



Fig. 15 Replacing the flow cell

Prerequisite The device is switched off and the power cable has been unplugged.

- Procedure** The following steps are recommended for disassembling the flow cell:
1. Switch off the device and pull the power plug.
 2. Open the device door.
 3. Remove capillaries at the inlet (①) and outlet (②) of the flow cell.
 4. Unscrew the knurled-head screws (③) of the cover plate.
Hold the flow cell securely with your hand during this procedure.
 5. Pull out the carriage of the flow cell (⑤) towards the front.
 6. Lift the flow cell up and out.
 7. Insert new flow cell from above into the carriage. Continue to hold the flow cell securely.
 8. Push the carriage back into the detector.
 9. Screw the knurled-head screws back into the cover plate (④) and tighten.
- Result** Flow cell has been replaced.

LAN

In case no connection between the computer and the devices can be established via LAN, go through the following steps. Check after each step if the problem is solved. If the problem cannot be located, call the Technical Support.

<p>1. Check the status of the LAN connection in the Windows taskbar:</p> <ul style="list-style-type: none"> ▪  Connected ▪  Connection not established <p>If no connection was established, test the following:</p> <ul style="list-style-type: none"> ▪ Is the router switched on? ▪ Is the patch cable connected correctly to the router and the computer? 	<input type="checkbox"/>
<p>2. Check the router settings:</p> <ul style="list-style-type: none"> ▪ Is the router set to DHCP server? ▪ Is the IP address range sufficient for all the connected devices? 	<input type="checkbox"/>
<p>3. Check all connections:</p> <ul style="list-style-type: none"> ▪ Is the patch cable connected to the LAN ports and not the WAN port? ▪ Are all cable connections between devices and router correct? ▪ Are the cables plugged in tightly? 	<input type="checkbox"/>

4. If the router is integrated into a company network, pull out the patch cable from the WAN port. ▪ Can the devices communicate with the computer, even though the router is disconnected from the company network?	<input type="checkbox"/>
5. In case you own a Control Unit, check the settings in the menu <i>Setup > Network</i> . ▪ Is <i>LAN-DHCP</i> set for controlling? ▪ Did the device receive an IP address?	<input type="checkbox"/>
6. Turn off all devices, router, and computer. Firstly, turn on the router and secondly turn on the devices and the computer. ▪ Has this been successful?	<input type="checkbox"/>
7. Replace the patch cable to the device which no connection could be established with. ▪ Has this been successful?	<input type="checkbox"/>
8. Ensure that the IP port of the device corresponds to the IP port set in the chromatography software.	<input type="checkbox"/>

Cleaning and caring for the device



CAUTION!

Intruding liquids can cause damage to the device!

Place solvent bottles next to the device or in a solvent tray.

Moisten the cleaning cloth only slightly.

All smooth surfaces of the device can be cleaned with a mild, commercially available cleaning solution, or with isopropanol.

Disposal

	Hand in old devices or disassembled old components at a certified waste facility, where they will be disposed of properly.
AVV marking in Germany	According to the German "Abfallverzeichnisverordnung" (AVV) (January, 2001), old devices manufactured by KNAUER are marked as waste electrical and electronic equipment: 160214
WEEE registration	KNAUER as a company is registered by the WEEE number DE 34642789 in the German "Elektroaltgeräteregister" (EAR). The number belongs to category 8. All distributors and importers are responsible for the disposal of old devices, as defined by the WEEE directive . End-users can send their old devices manufactured by KNAUER back to the distributor, the importer, or the company free of charge, but would be charged for the disposal.
Solvents and other operating materials	All solvents and other operating materials must be collected separately and disposed of properly. All wetted components of a device, e. g. flow cells of detectors or pump heads and pressure sensors for pumps, have to be flushed with isopropanol first and water afterwards before being maintained, disassembled or disposed.

Storage

Ambient storage conditions for the device

Temperature range: 4 – 40 °C; 39.2 – 104 °F

Humidity: below 90% noncondensing

System messages and troubleshooting

The system messages are sorted alphabetically:

System message	Solution
5-phase motor init failed	Switch the device off and on again. Check cable connection. If the system message appears again, notify KNAUER Technical Support.
At least one wavelength must be valid	Check whether at least one channel is on. Check that the entered the wavelengths are in the permissible range (190 nm to 750 nm).
Calibration failed	Switch the device off and on again. Check whether lamps, motor and filter are functioning correctly. If the system message appears again, notify KNAUER Technical Support. Restart calibration at the device or in the chromatography software.
Cannot delete active program/link	First pause link, then delete program.
Cannot edit program from the running link	First pause link, then edit data using chromatography software.
Cannot execute the command during calibration	Wait until calibration is finished before entering command.
Cannot initialize LAN	Check cables and connections in local area network.
Cannot operate an uncalibrated instrument	Switch the device off and on again. Wait until calibration is completed.
Cannot operate with an empty link	Create a link.
Cannot proceed: D2 lamp heating.	Wait until D2 lamp has preheated.
Cannot proceed: lamps are off.	Test whether the lamps have been switched on.
Cannot read data from FRAM	Switch the device off and on again. If the system message appears again, notify KNAUER Technical Support.

System message	Solution
Cannot read RTC	Switch the device off and on again. If the system message appears again, notify KNAUER Technical Support.
Cannot set acquisition parameters	Modify the entry.
Cannot start time table	Edit the data by means of the chromatography software.
Cannot write data on FRAM	Switch the device off and on again. If the system message appears again, notify KNAUER Technical Support.
CRC failed	Switch the device off and on again. If the system message appears again, notify KNAUER Technical Support.
D2 Lamp read failure Ignition counter	If the system message appears again, notify KNAUER Technical Support. The lamp has to be replaced.
D2 Lamp read Ignition counter	If the system message appears again, notify KNAUER Technical Support. The lamp has to be replaced.
D2 Lamp read lamp lifetime	If the system message appears again, notify KNAUER Technical Support. The lamp has to be replaced.
D2-Lamp does not start!	Switch off lamp and turn it on again. If the system message appears again, notify KNAUER Technical Support. The lamp unit has to be replaced.
Data acquisition active	No entries are possible. First stop acquiring measurement data, afterwards you can make a new entry.
Error input activated	Check the external devices and cable connections.
Error programming flash	Switch the device off and on again. If the system message appears again, notify KNAUER Technical Support.
Filter move error	Switch the device off and on again. If the system message appears again, notify KNAUER Technical Support.
I2C failed for lamp(s)	Switch the device off and on again. If the system message appears again, notify KNAUER Technical Support.

System message	Solution
I2C failed for panel	Switch the device off and on again. If the system message appears again, notify KNAUER Technical Support.
I2C Init failed	Switch the device off and on again. If the system message appears again, notify KNAUER Technical Support.
I2C operation failed	Switch the device off and on again. If the system message appears again, notify KNAUER Technical Support.
Instrument remote controlled	This entry is not executable. Quit software program.
Insufficient access	Change the entry.
Invalid command	Check the cable connections. Change the entry.
Invalid parameter(s)	Check the validity of the parameters.
Invalid time in time table	Correct the time entry.
Invalid time table index	Change the entry in the program line.
Link is loaded	First unload the link then change the link or delete it.
Link is running	Wait until the link has been executed, then change the link or delete it.
Memory error	Switch the device off and on again. If the system message appears again, notify KNAUER Technical Support.
No link available	Create a link and edit it.
No link available Pls edit link first	Create a link and edit it.
No time table to start	Edit the data by means of the chromatography software.
Not enough space to store link	Check the detector. Check the number of program lines. A maximum of 99 program lines are possible.
Not enough space to store program	Check the detector. Check the number of program lines. A maximum of 99 program lines are possible.
Not supported	Change the entry.

System message	Solution
Program does not exist	Create a program.
Program is running.	Quit program or wait until program has been completed.
This link is used in Wake up	First quit or delete wakeup program (wu = Wake Up), then edit or delete link.
This program is used in a link	First pause or delete link, then edit or delete data by means of the chromatography software.
This program is used in Wake up	First quit or delete wakeup program (wu = Wake Up), then edit or delete data by means of the chromatography software.
Time already exists	Correct the time entry.
Time table is not active	The device is in <i>Standalone mode</i> , no program is running. If you try to quit a non-existent program sequence, this message appears.
Time table is not loaded	First load the program, then start the program.
Time table line is empty	Edit the program line.
Too many lines in program	Check the number of program lines. A maximum of 99 program lines are possible.
Wrong Line number	Change the entry in the program line.

Technical data

Ambient conditions

Temperature range	4 – 40 °C, 39.2 – 104 °F
Humidity	below 90% noncondensing

Smartline detector 2520



Detector type	Variable single wavelength UV/VIS detector Variable single wavelength UV/VIS detector with fiber optic connectors
Detection channels	1
Light source	Deuterium (D ₂) lamp with integrated GLP chip
Wavelength range	190-750 nm
Spectral bandwidth	11 nm at H α line (FWHM)
Wavelength accuracy	± 2.5 nm
Wavelength precision	0.3 nm (ASTM E275-93)
Noise	± 1.5 x 10 ⁻⁵ AU at 254 nm ± 2.0 x 10 ⁻⁵ AU at 254 nm (fiber optics version) (ASTM E1657-98)
Drift	3.0 x 10 ⁻⁵ AU/h at 254 nm 4.0 x 10 ⁻⁴ AU/h at 254 nm (fiber optics version) (ASTM E1657-98)
Linearity	>2.0 AU at 270 nm (ASTM E1657-98)
Time constants	0.1 / 0.2 / 0.5 / 1.0 / 2.0 / 5.0 / 10.0 s
Integration time	Automatic
Maximum data rate	50 Hz (LAN, Analog) 10 Hz (RS-232)
Input	Error (IN), Start (IN), Autozero, 0-10 V Analog IN
Output	Events 1-3, +5 V, 24 V valve
Analog output	1 x 0 - 5 V scalable, 16 bit, offset adjustable

Control	Digital: RS-232, LAN-DHCP, remote connector Analog: wavelength control Manual: front panel
Programming	Timed: wavelength, events, fraction valve, links, wake up (program, link); 19 programs, 99 program lines
GLP function	Detailed report including lamp recognition, operating hours, lamp operating hours, number of lamp ignitions
Display	LCD
Power supply	100–240 V, 50–60 Hz, 75 W
Dimensions	226 x 135 x 410 mm (width x height x depth)
Weight	4.8 kg 4.9 kg (fiber optics version)
Protection	IP 20
Height above sea level	maximum 2000 meters

Delivery program

Devices and accessories

Name	Order number
Smartline UV/VIS detector 2520, without flow cell	A5150XA
Smartline UV/VIS detector 2520 Fiber Optics Version, without flow cell	A5151XA
User manual (English)	V5160A
Power supply cable 230 V	M1479
RS-232 cable (null modem cable)	M1922
Integrator cables	M1588
Connector strip, 12-pin	M1971
Stylus (micro lever pusher)	M1246
Flat ribbon cables	A1467
LAN network cable (Ethernet patch cable CAT5e)	A5255

Re-order

Name	Order number
Complete accessory package of the UV detector	F5150
Deuterium lamp for UV detector	A5193
Power supply cable	M1642
RS-232 cable (null modem cable)	M1922
Connector strip, 12-pin	M1971
Flat ribbon cable (10-pin, 1.5 m)	A1467
Integrator cable (2 x RCA)	M1588
Integrator cable (1 x RCA, 1 x labor plug)	G1023

Available Flow Cells

Most flow cells are also available equipped with fiber optical connectors for the use with the fiber optics version of the detector.

Analytical Flow Cells

Technical data		Order number
Path length Connection Inner diameter Volume Material Max. flow rate Max. pressure	10 mm 1/16" 1.1 mm 10 µl Stainless steel with heat exchanger 20 ml/min 300 bar	A4061XB
Path length Connection Inner diameter Volume Material Max. flow rate Max. pressure	10 mm 1/16" 1.1 mm 10 µl Stainless steel with heat exchanger 20 ml/min 300 bar	A4061 A4074 (fiber optics version)
Path length Connection Inner diameter Volume Material Max. flow rate Max. pressure	3 mm 1/16" 1.0 mm 2 µl Stainless steel 50 ml/min 300 bar	A4042 A4044 (fiber optics version)
Path length Connection Inner diameter Volume Material Max. flow rate Max. pressure	3 mm 1/16" 1.0 mm 2 µl PEEK 50 ml/min 30 bar	A4045 A4047 (fiber optics version)

Preparative Flow Cells

Technical data		Order number
Path length Connection Inner diameter Volume Material Max. flow rate Max. pressure	0.5 / 1.25 / 2 mm 1/8" 2.3 mm 1.7 / 4.3 / 6.8 µl Stainless steel 1000 ml/min 200 bar	A4066 A4078 (fiber optics version)
Path length Connection Inner diameter Volume Material Max. flow rate Max. pressure	0.5 / 1.25 / 2 mm 1/8" 2.3 mm 1.7 / 4.3 / 6.8 µl PEEK 1000 ml/min 100 bar	A4067 A4079 (fiber optics version)
Path length Connection Inner diameter Volume Material Max. flow rate Max. pressure	0.5 / 1.25 / 2 mm 1/4" 4.0 mm 1.7 / 4.3 / 6.8 µl Stainless steel 10000 ml/min 200 bar	A4068 A4081 (fiber optics version)
Path length Connection Inner diameter Volume Material Max. flow rate Max. pressure	0.5 / 1.25 / 2 mm 1/4" 4.0 mm 1.7/4.3/6.8 µl Stainless steel 10000 ml/min 200 bar	A4068-2
Path length Connection Inner diameter Volume Material Max. flow rate Max. pressure	0.5 mm 1/16" 0.8 mm 3 µl Stainless steel 250 ml/min 200 bar	A4069 A4089 (fiber optics version)
Path length Connection Inner diameter Volume Material Max. flow rate Max. pressure	0.5 mm 1/16" 0.8 mm 3 µl PEEK 250 ml/min 100 bar	A4095 A4096 (fiber optics version)

Fiber Optics Preparative Flow Cells

Technical data		Order number
Path length Capillary connection Material Max. pressure	10 mm 1/2" with TRI-Clamp PEEK and fused silica 10 bar	A4154-1
Path length Capillary connection Material Max. pressure	7 mm 3/8" with TRI-Clamp PEEK and fused silica 10 bar	A4152-1
Path length Capillary connection Material Max. pressure	0.5/1.25/2 mm 1/2" with TRI-Clamp Stainless steel and fused silica 80 bar	A4154
Path length Capillary connection Material Max. pressure	0.5/1.25/2 mm 3/4" with TRI-Clamp Stainless steel and fused silica 80 bar	A4155
Path length Capillary connection Material Max. pressure	0.5/1.25/2 mm 3/8" with TRI-Clamp Stainless steel and fused silica 80 bar	A4152
Path length Capillary connection Material Max. pressure	0.5/1.25/2 mm 1/4" with TRI-Clamp Stainless steel and fused silica 80 bar	A4153

Test Cells

Technical data		Order number
Test cell	normal	A4123 A4125 (fiber optics version)
Test cell	holmium oxide filter	A4126 A4128 (fiber optics version)
Test cell	filter stray light	A4146 A4148 (fiber optics version)

Flow cell replacement parts

- For analytical flow cells

Name	Order number
Lens for A4061V2 flow cell	N0077
Lens for A4061 flow cell	N0001
Compression part	P2633
Compression bushing	P2644
PTFE seal	M1302

- For preparative flow cells

Name	Order number
Fiber optics (quartz glass rod)	N0076
Compression bushing	P2644
PEEK spacer	P2645
Stainless steel cover	P2646
PTFE seal ring	P7003

Legal information

Warranty Conditions

The factory warranty for the device is valid for 12 months after the date of dispatch. All warranty claims shall expire in the event that any unauthorized changes are made to the device.

During the warranty period, any components with material or design-related defects will be replaced or repaired by the manufacturer free of charge.

This warranty excludes the following:

- Accidental or willful damage
- Damage or errors caused by third parties that are not contractually related to the manufacturer at the time the damage occurs
- Wear parts, fuses, glass parts, columns, light sources, cuvettes and other optical components
- Damage caused by negligence or improper operation of the device and damage caused by clogged capillary
- Packaging and transport damage

In the event of device malfunctions, directly contact the manufacturer.

Wissenschaftliche Gerätebau
Dr. Ing. Herbert Knauer GmbH
Hegauer Weg 38
14163 Berlin, Germany
Phone: +49 30 809727-111
Telefax: +49 30 8015010
e-mail: info@knauer.net
Internet: www.knauer.net

Transport Damage

The packaging of our devices provides the best possible protection against transport damage. Check the devices for signs of transport damage. In case you notice any damage, contact the Technical Support and the forwarder company within three workdays.

HPLC Glossary

In the following chapter you find abbreviations and terminology that is used in HPLC.

Term	Definition
Absorption	A substance retaining light of certain wave-lengths when being shone at.
Adsorption	The stationary phase attracting the molecules of separated substances.
Analytical	Qualitative analysis of samples in HPLC (see: preparative)
Backflushing	Flushing of columns and pre-columns by reversing the flow direction. This enables strongly retarding substances to be separated.
Calibration	Process for correcting measuring values by the value that a measuring device deviates from the standard.
Capillary	Thin metal or PEEK pipe that connects the components and devices inside of an HPLC system.
Carrier material	Solid particles which carry the stationary phase (packing material).
Chromatogram	The record of a detector signal, depending on the flow volume of the mobile phase or time.
Column	The pipe with two end fittings which is permeable for solvent. The pipe is filled with packing material.
Correction factor	Factor that arithmetically corrects device-related deviations from measuring values.
Dead volume	Volume of capillary and system components between mixer, injector and column as well as between column and detector.
Degasser	Degasser module for fluids
Detector	Device measuring the composition or the quantity of a substance
Flow cell	Measuring cell
GLP	Quality assurance system for laboratories (Good Laboratory Practice)
Gradient	Time-dependent composition of solvent (mobile phase) on low-pressure or high-pressure side of system

Term	Definition
Ground	Protective measure for electro-conductive housing parts
HPLC	High Pressure Liquid Chromatography (HPLC)
isocratic	Mode of sample separation where the composition of a solvent remains constant
Luer-Lock cannula	A standardized connector between syringes and cannulas
Mobile phase	Flowing agent that transports the substances to be separated or isolated through the column (solvent).
Packing material	Solid particles which carry the stationary phase (carrier material).
Peak	The deflection of a detector for an analyte in a chromatogram.
pH	Measure for the acidic or alkaline character of an aqueous solution.
pH electrode	pH sensor
Preparative	Isolating the maximum amount of a substance in a short amount of time in a required purity.
Retention time	The time required from injection of a substance until the maximum concentration of a substance becomes visible.
Sample	A mixture of different components which are to be separated via chromatography. The components are moved by the mobile phase and dissolved from the column.
Sample loop	A loop which is separate from a chromatographic system and which the sample is injected to. After a switch is actuated, the solvent flow passes the loop and the sample is flushed onto the column.
Solvent	Flowing agent that transports the substances to be separated or isolated through the column (mobile phase)
Stationary phase	The stationary substance in a chromatographic system on which the substance to be separated settles. It is the liquid or the liquid film on the surface of the packing material.

Table of Figures

Fig. 1:	Front of device with door open and analytical flow cell	20
Fig. 2:	Connect the connector strip with the cable	23
Fig. 3:	Terminal strip Event and remote control	24
Fig. 4:	Cabling system LAN	28
Fig. 5:	Structure of the Setup menu	35
Fig. 6:	Structure of the GLP menu	38
Fig. 7:	Creating a program	40
Fig. 8:	Running a program	41
Fig. 9:	Changing a program	42
Fig. 10:	Deleting a program	43
Fig. 11:	Creating a wakeup program	44
Fig. 12:	Creating a link	45
Fig. 13:	Executing a link	46
Fig. 14:	Deleting a link	47
Fig. 15:	Replacing the flow cell	51

Index

A

abbreviations 67
Absorption 67
Additives 7
Adsorption 67
Ambient conditions 54
analytical 67
automatic configuration 6
AVV marking 54

B

Backflushing 67

C

Calibration 67
Capillary 67
Carrier material 67
changing a program 42
changing the optical path length 21
Checklist before initial operation 19
Chromatogram 67
Chromatography Software 26
Cleaning and caring for the device 53
Cleaning the fiber optics 50
Cleaning the lens 49
Column 67
Connecting the detector to other devices 23
Connecting to a local area network (LAN) 27
connector strip 23
controlling the detector 30
controlling the GLP menu 37
controlling the link menu 44
controlling the main menu 31
controlling the program menu 39
controlling the set up menu 33
Correction factor 67
creating a link 45
Creating a program 43
creating a program 40

D

Dead volume 67
Declaration of Conformity 76
Decontamination 12
Degasser 8, 67
deleting a link 47
deleting a program 42

Delivery program 61
Detector 67
Device Overview 16
Disposal 54

E

electrical connections 23
Eluents 7
error messages, see system messages 55
executing a link 45

F

Features 9
Fiber optics 72
Flow cell 67
 Analytical 62
 Types 62
Flow cell replacement parts 65

G

Glossary 67
GLP 67
GLP menu 37
Gradient 67
Ground 68

H

HPLC 6, 68
HPLC Glossary 67

I

Inspecting the flow cell 75
Installation 14
Installation of the flow cell 19
installation site 14
Intended use 6
Isocratic 68

L

Labels 13
Laboratory use 6
LAN 27
 connectivity problems 52
 port 29
 router 28
 settings 27
 setup 27
LAN - Troubleshooting 52
Leak 11
Legal information 66

Local network 6
Luer-lock cannula 68

M

maintenance 48
Maintenance contract 48
manual entry of control signals 25
Markings 13
Mobile phase 68
Modifiers 7

O

Order numbers,
see delivery program 61
overview of buttons 17

P

Packaging 14
Packing material 68
Peak 68
PEEK 7
pH 68
pH electrode 68
Port (LAN) 29
Power connection 15
Power supply 11, 15
 power cable 11
 power strip 11
preparative 68
Professional group 10
Program menu 39
Purging the flow cell 49

R

Rear View 18
Replacing the flow cell 51
Replacing the flow cell
on the fiber optics version 72
Retention time 68
Router (LAN) 28
running a program 41

S

Safety 10
Safety equipment 10
Salts 7
Sample 68
Sample loop 68
selecting the GLP menu 32
selecting the Link menu 32
selecting the Program menu 32
selecting the Setup menu 32

selection of the wavelength 31
Setup menu 34
Solvent 68
 flammability 11
 line 11
 self-ignition point 11
 toxicity 11
 tray 11
startup 19
Stationary phase 68
Storage 54
Storing a flow cell 75
Switching the detector on 30
Symbols 13
System messages 55

T

Technical data 59
Technical Support 48
terminal strip
 event and remote control 24
Test Cells 65
Transport 14
Transport damage 66
Troubleshooting 55

W

WAKE UP program 43
Warranty 66

Annex

Replacing the flow cell on the fiber optics version of 2520

UV light will cause the optical fibers to become blind with time (solarization), making them no longer suitable for use.

The details of the following are described:

- Removing the flow cell
- Installing the flow cell
- Reordering spare parts

Practical tip! Observe the following regarding the UV optical fibers:

- Do not touch the tip of the UV optical fiber with your fingers.
- Move the optical fiber carefully without using pressure or bending it.

- Tools**
- Isopropanol
 - Cotton swab
 - Filler caps/closures for the flow cell

Duration ▪ Approx. 25 min.

Level of difficulty ▪ Level 3 (from 1 to 7, very easy to very difficult)

Inserting the flow cell

- Prerequisites**
- The device has been switched off.



WARNING!

Irritation of retina through UV light! Concentrated UV light can leak out from the flow cell or the fiber optic connectors.

Switch off the device and pull the power plug.

- Note:** Do not touch the tip of an optical fiber with your fingers, as this could falsify the measurement.

Inserting the flow cell

Procedure	Figure
<p>1. Remove the caps (①, ②, ③) of the flow cell and fiber optics.</p>	
<p>2. Tighten the fittings (④, ⑤) of the fiber optics to the flow cell by hand until finger-tight.</p>	

Inserting the flow cell

Procedure	Figure
<ol style="list-style-type: none"> 3. Open the door of the detector and pull the fiber optics through the holes (⑥) in the door. 4. Tighten the fittings (⑦) of the fiber optics to the detector by hand until finger-tight. 5. Close the door of the detector. 6. Mount the flow cell in a suitable position. 	

Purging the flow cell

This process is described in the manual on page 48.

Removing the flow cell**Prerequisites**

- The flow cell has been flushed.
- The device has been switched off.

Removing the flow cell

Procedure	Figure
<ol style="list-style-type: none"> 1. Loosen the fitting (①, ②) of the fiber optics to the flow cell by hand. 	

Removing the flow cell

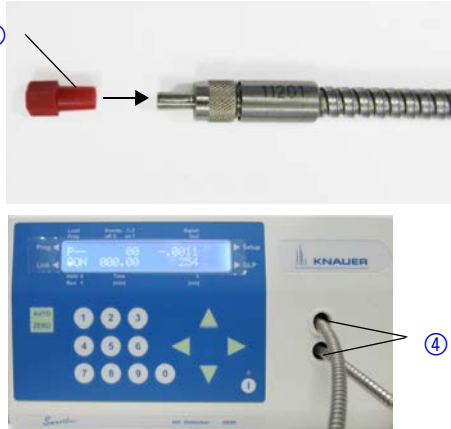
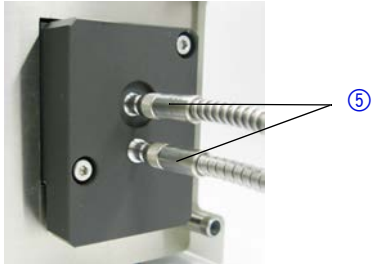
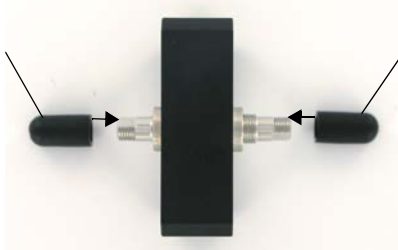
Procedure	Figure
<p>2. Seal the fiber optics endings with caps (③).</p> <p>3. Open the door of the instrument.</p> <p>4. Pull the fiber optics through the holes (④) in the door.</p>	
<p>5. Loosen the fiber optics (⑤) of the flow cell by hand.</p> <p>6. Seal the other fiber optics endings with caps.</p>	
<p>7. Seal the fiber optics connectors of the flow cell with caps (⑥, ⑦) and store securely.</p>	

Storing a flow cell

Prerequisite The flow cell has been flushed.

Fill the flow cell with isopropanol and close with filler caps. This will protect the flow cell from germs.

Inspecting the flow cell

OQ test With the replaced flow cell, run the comprehensive function test (operation qualification test) of the device in the chromatography software.

Practical tip! The integration time may not exceed 100 ms and is dependent upon the type of flow cell as well as the length, radius and age of the optical fibers.

Declaration of Conformity

Manufacturer name and address	Wissenschaftliche Gerätebau Dr. Ing. Herbert KNAUER GmbH Hegauer Weg 38 14163 Berlin, Germany
Smartline Detector 2520	Product number(s): E4317XA (with deuterium lamp), E4318XA (with fiber optics) Complies with the following requirements and product specifications:
Europe	<ul style="list-style-type: none">▪ DIRECTIVE 2006/42/EC OF THE EUROPEAN PARLIAMENT AND OF THE COUNCIL of 17 May 2006 on machinery, and amending Directive 95/16/EC (recast)▪ IEC 60799 (June 1998) Electrical accessories - Cord sets and interconnection cord sets▪ IEC 61010-1 (2010 + Corrigendum: 2011) Safety requirements for electrical equipment for measurement, control and laboratory use<ul style="list-style-type: none">▪ IEC 61010-2-081 (2001 + A1:2003) Safety requirements for electrical equipment for measurement, control and laboratory use - Part 2-081: Particular requirements for automatic and semi-automatic laboratory equipment for analysis and other purposes▪ IEC 61010-2-010 (2003) Safety requirements for electrical equipment for measurement, control, and laboratory use - Part 2-010: Particular requirements for laboratory equipment for the heating of materials▪ Low voltage directive (2006/95/EC)▪ IEC 61000-3-2 (2005 + A1:2008 + A2:2009) Electromagnetic compatibility (EMC) Part 3-2<ul style="list-style-type: none">▪ EMC standard (2004/108/EC)▪ IEC 61326-1 (2012) Electrical equipment for measurement, control and laboratory use – EMC requirements – Part 1: General requirements▪ Directives for an environmentally sound use of electrical and electronic equipment<ul style="list-style-type: none">▪ RoHS directives 2002/95/EC (2003) and 2011/65/EU on the restriction of the use of certain hazardous substances in electrical and electronic equipment▪ WEEE directive 2002/96/EC (2003) and 2012/19/EU on waste electrical and electronic equipment

The device was tested with a typical configuration.

Berlin, 2014-08-13



Alexandra Knauer (CEO and owner)

The mark of conformity has been applied to the rear panel of the device.



© Wissenschaftliche Gerätebau
Dr. Ing. Herbert Knauer GmbH
All rights reserved.
Technical data are subject to change without notice. Please check our
website for latest updates and changes.
Translation of the original German edition of this manual, version 1.2
Last manual update: 2014-08-13
Printed in Germany on environmentally friendly paper from sustaina-
ble forests.

® ChromGate und ClarityChrom
are registered trademarks of
Wissenschaftliche Gerätebau
Dr. Ing. Herbert Knauer GmbH

▶ See up-to-date manuals online:
www.knauer.net/downloads

www.knauer.net

HPLC · SMB · Osmometry

Wissenschaftliche Gerätebau
Dr. Ing. Herbert Knauer GmbH
Hegauer Weg 38
14163 Berlin, Germany

Phone: +49 30 809727-0
Telefax: +49 30 8015010
E-Mail: info@knauer.net
Internet: www.knauer.net



© KNAUER 2013 V5160A/0.05/10.13/Koe