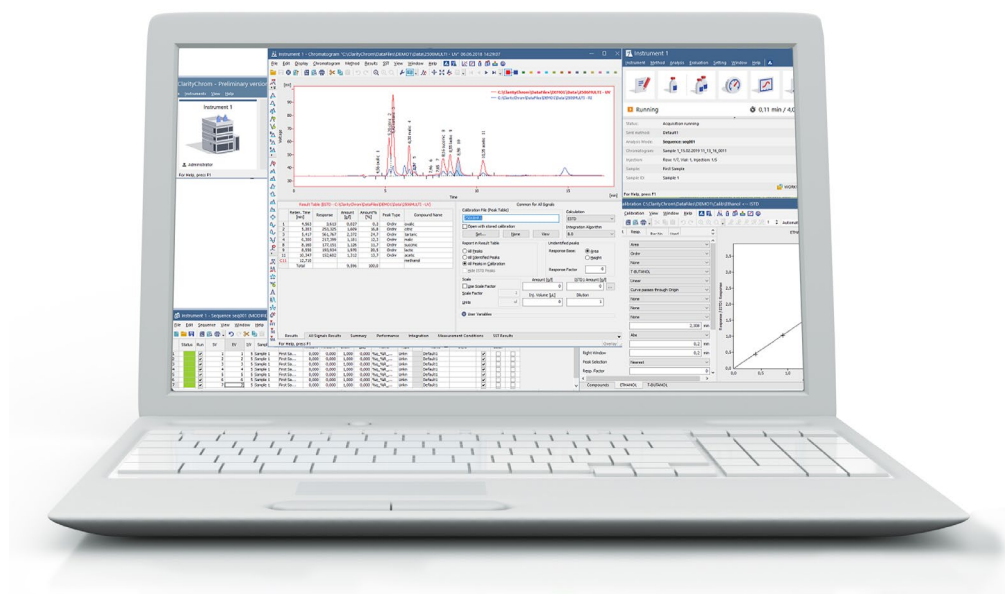


Science Together



# ClarityChrom®

Version 8.5  
Software instructions



Document no. V1670

# SOFTWARE



**Note:** For your own safety, read the instructions and observe the warnings and safety information on the device and in the instructions. Keep the instructions for future reference.



**Note:** In case you require this instruction in another language, please submit your request including the corresponding document number via e-mail or fax to KNAUER.

**Support:** Do you have questions about the installation or the operation of your instrument or software?

**International Support:**

Contact your local KNAUER partner for support:

[www.knauer.net/en/Support/Distributors-worldwide](http://www.knauer.net/en/Support/Distributors-worldwide)

**Support in Germany**

(Austria & Switzerland on case-to-case basis):

Phone: +49 30 809727-111 (workdays 9-17h CET)

Fax : +49 30 8015010

Email: [support@knauer.net](mailto:support@knauer.net)

**Publisher:** KNAUER Wissenschaftliche Geräte GmbH

Hegauer Weg 38

14163 Berlin

Germany

Phone: +49 30 809727-0

Fax: +49 30 8015010

Internet: [www.knauer.net](http://www.knauer.net)

E-Mail: [info@knauer.net](mailto:info@knauer.net)

**Version information:** Document number: V1670

Version number: 7.3

Release date: 2021/06/16

Original edition

The information in this document is subject to change without prior notice. For the latest version of the instructions, visit our website: [www.knauer.net/library](http://www.knauer.net/library).



**Copyright:** This document contains confidential information and may not be reproduced without written consent of KNAUER Wissenschaftliche Geräte GmbH.

© KNAUER Wissenschaftliche Geräte GmbH 2021

All rights reserved.

---

# Table of contents

<b>1. Product information</b>	<b>1</b>
1.1 Intended use	1
1.2 Supported instruments	2
<b>2. Key features</b>	<b>5</b>
2.1 Computer and operating system requirements	7
<b>3. Installation</b>	<b>8</b>
3.1 Scope of delivery	8
3.2 Software installation	8
3.3 Software upgrade	15
<b>4. Program structure and control</b>	<b>16</b>
4.1 ClarityChrom® main window	16
4.2 The instrument window	17
4.3 The chromatogram window	19
4.4 The calibration window	20
4.5 The sequence window	21
4.5.1 Active sequence:	21
4.6 Method setup	22
<b>5. First analyses</b>	<b>23</b>
5.1 Program start	23
5.1.1 Signal recording	23
5.1.2 Measurement and evaluation parameters	23
5.1.3 Analysis process	24
5.1.4 Analysis recording	24
5.1.5 Chromatogram display and evaluation	25
5.1.6 Calibration	26
<b>6. Mobile Control with ClarityChrom®</b>	<b>26</b>
<b>7. Configuration - systems and devices</b>	<b>27</b>
7.1 Configuration - device communication port	28
7.2 Connections for device control from PC via LAN	29
7.2.1 Configuring the LAN settings	29
7.2.2 Connecting the cables	30
7.2.3 Configuring the router	30
7.2.4 Integrating the LAN into a company network	30

---

7.2.5	Troubleshooting LAN	31
7.3	Configuration by downloading from the device	31
7.4	Configuration - KNAUER pumps	32
7.5	Configuration - KNAUER detectors	39
7.5.1	Configuration - KNAUER RI detectors	39
7.5.2	Configuration - KNAUER UV detectors	41
7.5.3	Configuration - KNAUER UV detectors with PDA functionality	44
7.5.4	Configuration - KNAUER PDA detectors	47
7.5.5	Configuration - Spectrofluorometric Detector RF-10AxI, RF-20A/Axs	50
7.5.6	Configuration - Conductivity Monitor Smartline 2900, AZURA® CM 2.1S	53
7.5.7	Configuration - virtual detector	54
7.6	Configuration - KNAUER interfaces	55
7.6.1	Configuration - KNAUER interface channels	59
7.6.2	Detector connections	62
7.7	Configuration - AZURA® Assistants ASM 2.1L / ASM 2.2L	63
7.7.1	Configuration rules	63
7.8	Configuration - autosamplers	67
7.9	Configuration - column thermostat	69
7.10	Configuration - switching valves	71
7.11	Configuration - Fraction collectors	74
7.11.1	Configuration - general settings of fraction collectors	74
7.11.2	Configuration - Smartline 3050 fraction collector	76
7.11.3	Configuration - KNAUER MultiValve fraction collector	78
7.11.4	Configuration - Foxy R1 / R2 Fraction Collectors	81
7.11.5	Configuration - Labocol Vario 4000 / 4000 Plus	82
7.11.6	Configuration - Other fraction collectors	84
7.12	Configuration - completing instruments	85
7.13	Configuration - instrument type	85
7.14	Configuration - device (start input)	85
7.15	Configuration - units setup	86
7.16	Configuration - method sending	87
<b>8.</b>	<b>Setup - systems and instruments</b>	<b>89</b>
8.1	Autosampler	92
8.1.1	Mode, time and temperature	94
8.1.2	Inputs and outputs	97
8.1.3	Mix methods	98
8.1.4	System settings	99
8.1.5	Tray	101
8.2	LC Gradient	102

---

---

8.3	LC .....	104
8.4	Measurement .....	107
8.5	Acquisition, Detector Method .....	108
8.5.1	Acquisition, RI Detector Method .....	109
8.5.2	Acquisition, UV detector method .....	112
8.5.3	Channel depending settings .....	114
8.5.4	Acquisition spectrofluorometric detector RF-10AxI/20A/20Axs .....	116
8.5.5	Acquisition conductivity monitor AZURA® CM 2.1S and Smartline S 2900 ..	116
8.5.6	Channel dependent settings – User defined detector .....	118
8.5.7	Channel dependent settings – Virtual detector .....	118
8.6	Assistants ASM 2.1L / ASM 2.2L Setup .....	122
8.7	Setup switching valves .....	123
8.8	PDA, Detector method .....	125
8.8.1	PDA, Scan .....	125
8.9	PDA Method .....	126
8.10	Thermostat (column ovens) .....	126
8.11	Integration .....	128
8.12	Calculation .....	128
<b>9.</b>	<b>Setup and programming fraction collectors .....</b>	<b>129</b>
9.1	Fraction collection program (FC settings) .....	130
9.2	Editing of fraction collection programs .....	133
<b>10.</b>	<b>Device Monitor .....</b>	<b>136</b>
10.1	Device Monitor – Pumps .....	137
10.2	Device Monitor – Auxiliary pump .....	139
10.3	Device Monitor – KNAUER RI detectors .....	139
10.4	Device Monitor – KNAUER UV Detectors .....	141
10.5	Device Monitor – KNAUER PDA Detectors .....	141
10.6	Device Monitor – Virtual detector .....	145
10.7	Device Monitor – Assistant ASM 2.1L / ASM 2.2L .....	145
10.8	Device Monitor – autosamplers .....	146
10.9	Device Monitor – column oven .....	147
10.10	Device Monitor – KNAUER Switching Valves .....	149
10.11	Device Monitor – fraction collectors .....	149

# 1. Product information



**Note:** Lost or stolen hardware keys (dongles) will not be replaced. If the dongle is lost, the license for using the software is lost.

## 1.1 Intended use



**Note:** Only use the device for applications that fall within the range of the intended use. Otherwise, the protective and safety equipment of the device could fail.

The chromatographic station ClarityChrom® is an effective tool for the acquisition, processing and evaluation of data from any as well as for the controlling of KNAUER HPLC systems. Additionally, further devices and systems with a digital interface are supported. Via an A/D converter, data can be acquired from any gas or liquid chromatograph. In the maximum configuration it is possible to measure on and control up to four chromatographs simultaneously, depending on their configuration.

The station is equipped with support for automatic co-operation with chromatographs and autosamplers.

ClarityChrom® offers the possibility to work under fulfillment of the requirements of directive 21 CFR Part 11 of the FDA.



Beside the built-in fraction options, KNAUER offers a fraction collectors Add-on for ClarityChrom®. This Add-on allows for controlling several fraction collectors and using special fractionation algorithms. Chapters and sections of this manual which refer only to the preparative option from KNAUER are indicated by the marginal icon of the KNAUER Prepline system.

## 1.2 Supported instruments



**Note:** The supported functionality depends on the firmware version or communication interface.

ClarityChrom® currently supports the following KNAUER instruments:

Device type	Name
<b>Detectors</b>	AZURA® DAD 6.1L
	AZURA® DAD 2.1L
	AZURA® MWD 2.1L
	AZURA® RID 2.1L / RID 2.1L HighFlow
	AZURA® UV Detector UVD 2.1L
	AZURA® UV Detector UVD 2.1S
	AZURA® Conductivity Monitor CM 2.1S
	AZURA® Electrochemical Detector ECD 2.1 <sup>1</sup>
	PLATINblue PDA-1
	PLATINblue MW-1
	Smartline UV Detector 200
	Smartline UV Detector 2500
	Smartline UV Detector 2520
	Smartline UV Detector 2550
	Smartline UV Detector 2600
	Smartline RI Detector 2300
	Smartline RI Detector 2400
	Smartline PDA Detector 2850
	Smartline PDA Detector 2800
	Smartline Conductivity Monitor 2900
	WellChrom Detector K-2000/2001
	WellChrom Detector K-2500/2501
	WellChrom Detector K-2600
	WellChrom Detector K-2700
	WellChrom Detector K-2800
	WellChrom Detector K-2300/2301
	WellChrom Detector K-2400/2401
	Shimadzu Spectrofluorometric Detector RF-10AxI / RF-20A

<sup>1</sup> Supported as Antec Decade Elite; refer to the separate manual on ClarityChrom® installation medium.

Device type	Name
<b>Pumps</b>	AZURA® Pump P 6.1L (isocratic, LPG, HPG, p-max mode, no constant pressure mode)
	AZURA® Pump P 2.1L (isocratic, LPG, HPG, no isobar mode)
	AZURA® Pump P 2.1S/4.1S (isocratic, HPG)
	PLATINblue Pump P-1 (isocratic, LPG, HPG)
	Smartline Pump 1050 (isocratic, LPG, HPG)
	Smartline Pump 1000 (isocratic, LPG, HPG)
	Smartline Pump 100 (isocratic, HPG)
	Smartline Pump 1800 (isocratic, LPG, HPG)
	WellChrom Pump K-1800 (isocratic, LPG, HPG)
	WellChrom Pump K-120 (isocratic, HPG)
	WellChrom Pump K-501 (isocratic, HPG)
	WellChrom Pump K-1000 (isocratic, LPG, HPG)
	WellChrom Pump K-1001(isocratic, LPG, HPG)
<b>Assistant</b>	AZURA® Assistant ASM 2.1L
	AZURA® Assistant ASM 2.2L
<b>Column Thermostat</b>	Column Thermostat CT 2.1
	PLATINblue T-1
	Smartline 4050
	JetStream
<b>Interfaces (A/D converter)</b>	Smartline Manager 5000 / 5050 (Interface module)
	IF2 / IFU 2.1 / IFU2.1 LAN
	KNAUER HPLC Box 96
<b>Autosampler</b>	AZURA® Autosampler AS 6.1L
	Smartline AS 3800 (Spark Marathon)
	Autosampler 3900 (Spark MIDAS)
	AS 3950
	Knauer Optimas
	PLATINblue AS-1
<b>Valves</b>	AZURA® VU 4.1
	AZURA® V 2.1S
	Smartline Valves
	WellChrom Valves





Device type	Name
<b>Fraction Collectors</b>	Smartline FC 3050
	KNAUER Multi Valve FC
	KNAUER Virtual FC
	ISCO Foxy R1
	ISCO Foxy R2
	ISCO Foxy Jr.
	Buechi C660
LABOCOL Vario 4000/Plus	
.....	
<b>Others</b>	Bronkhorst Mini-Coriflow Flowmeter
.....	

---

## 2. Key features

- **Measuring**  
Simultaneous data acquisition from up to four independent chromatographs. One chromatograph can acquire data from up to 12 detectors. Only two full-equipped systems per computer are recommended.
- **Integration**  
There is extensive possibility to modify chromatograms. The chromatogram can be changed by entering global parameters or interactively, through direct graphic modification of the baseline.
- **Overlay**  
Simultaneously displays a virtually unlimited number of chromatograms and their mathematical modification; for example, mutual deductions or derivations of any order.
- **Calibration**  
Internal and external standard calculation methods, calibration of groups of peaks and reference peaks method for better identification.
- **Wide range of supported instruments**  
Control modules in ClarityChrom® allow users to control various instruments in their lab. See our growing list of supported instruments, V1677, on KNAUER webpage.
- **Extensions completing your workflow**  
ClarityChrom® Extensions integrates your workflow into one application. GPC calculations, PDA data processing, gas or detailed hydrocarbon analyses according to selected norms and even more.
- **Automated measuring support**  
Sequence tables for any set of samples with or without an autosampler can be created.
- **Postrun**  
Automatically displays, prints, exports and starts other programs after the completion of a measurement.
- **Summary result tables**  
Display and print of selected results from all simultaneously displayed chromatograms.
- **User settings**  
User selects parameters for peak display and the specification for axes, including color from an extensive array of color settings. Text labels and lines, either as part of the area or anchored to a chromatogram, may also be inserted.
- **Export**  
Optional exportation of all results, with or without the chromatogram, in various formats, into a file or clipboard is supported.
- **Import**  
This functionality allows importing chromatograms or mathematical curves, which have been saved in text or AIA formats, from other programs.
- **LIMS**  
ClarityChrom® offers connectivity with LIMS both for sample submission and result output. This can be done via convenient ASCII transfers.

- **Method and calibration history**  
Each chromatogram can easily be displayed under the same conditions as when it was printed, exported or saved.
- **Column performance**  
Calculation of peaks in terms of symmetry, efficiency, resolution; all by several methods (tangent, moments, etc.).
- **Batch**  
Automatically batch processes, displays, exports or prints any number of chromatograms.
- **User calculations**  
Users can define custom calculations in the result and summary tables. Using the integrated editor you can create your own columns from original columns and individual mathematical functions.
- **User accounts**  
Sets up access rights and passwords (including their parameters e.g., minimum length, validity, etc.). Each user can define its own station appearance.
- **Audit trail**  
Records selected events and operations into a special file. Records selected operations directly into a chromatogram.
- **Electronic signature**  
Each chromatogram can be signed electronically. Signature selection is based on the username or the signature certificate.
- **Networked solution**  
ClarityChrom® chromatography station files can be accessed from networked computers using ClarityChrom® offline software. This enables the offline evaluation of chromatograms, development of new methods and printing reports.
- **Language localizations available**  
At the moment, there are French, German, Russian, Spanish and Chinese localizations available in single installation package. Switch to your preferred language anytime. Some device-dependent menus are only in English.
- **Fraction collection**  
Time- or signal-triggered fractionation. The KNAUER FRC module also offers the support of fraction collectors from different manufacturers and KNAUER valves for fractionation. In addition, solvent recycling, manual and mass-triggered fractionation are supported, as well as a rack view with details about each collected fraction and direct links to the matching chromatograms.
- **LC/GC/AS/MS control**  
Integrated Add-on modules for controlling selected types of chromatographs, autosamplers and mass spectrometers.
- **Free demo or trial version available**  
The demo version allows checking the workflow in the software or learning chromatogram calculation or calibration using the demo chromatograms. It does not allow for device control or data acquisition or to open self-acquired chromatograms but runs for an unlimited time.

The trial version runs for 30 days or 100 starts of the software with all options including device control and data acquisition. While the demo version can be downloaded from the KNAUER webpage, the trial version requires a license dongle.

## 2.1 Computer and operating system requirements

The ClarityChrom® workstation runs on Windows 10, Windows 8, Windows 7 SP1; all 32- and 64-bit, and in any language version.

Architecture	Minimum requirements
<b>Operating system</b>	Windows 10/8.1/7
<b>CPU</b>	Pentium 2000 MHz
<b>RAM</b>	4 GB
<b>Graphics</b>	For a single system, an „onboard“ solution (chipset or graphics processor) is sufficient. If more than one system has to be controlled, a separate graphics board is recommended.
<b>Free disc space</b>	80 GB for installation and data storage. The program uses approx. 1 GB of disc space. The chromatogram file size of PDAs ranges between 2 and 5 MB, for MS data the range is 3-6 MB. An SSD instead of a HDD is highly recommended.
<b>Interfaces and PC slots</b>	1 x USB for the licence dongle. Interfaces for connecting the devices, type and number depending on the supported interfaces (LAN, serial, USB), serial interfaces can be retrofitted with corresponding adapters. Some adapters require a special PC slot; drivers for those cards may not be available for newer Windows versions.
<b>Optical drive</b>	DVD-ROM drive for the installation
<b>Monitor</b>	Minimum 1680 × 768, 64 K colors (16 bit - high color); recommended 1280 × 1024 or 1680 × 1050, 64 K colors (16 bit - high color)

## 3. Installation

The installation procedures of both software packages, the analytical and the preparative one, are identical.



**Note:** Lost or stolen hardware keys (dongles) will not be replaced. If the dongle is lost, the license for using the software is lost.

### 3.1 Scope of delivery

Verify that the package is complete according to the packing list.

- ClarityChrom® DVD
- USB hardware key
- ClarityChrom® Certificate with user Code
- Safeguard dongle protection
- Instruction sheet for the installation of ClarityChrom®

### 3.2 Software installation



**Note:** The installation has to be performed under a local administrator account. If Windows has found updates to be installed, first install the Windows updates and reboot the computer before you install ClarityChrom®.

Installing ClarityChrom® is very simple. Firstly, please start Windows - if it is already running, close all the user programs currently open.

During installation, it is highly recommended to disable the real-time scanner of an installed anti-virus software.



**Note:** Do not insert your USB licence dongle into the PC slot before the ClarityChrom® software is installed.

Depending on the configuration, Windows may ask you during installation if you trust the manufacturer and want to continue the installation. Always confirm with „Yes“. Otherwise it cannot be guaranteed that the installation is complete and the software works as described.

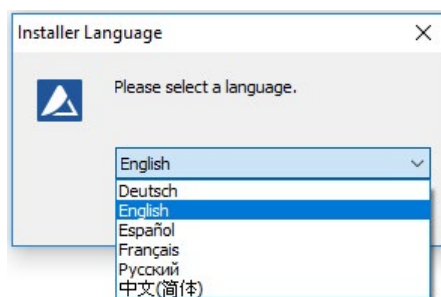
Insert the ClarityChrom® DVD into the DVD drive. After a period of about 30 s, the installation menu will appear.



**Fig. 1:** Installation, main menu

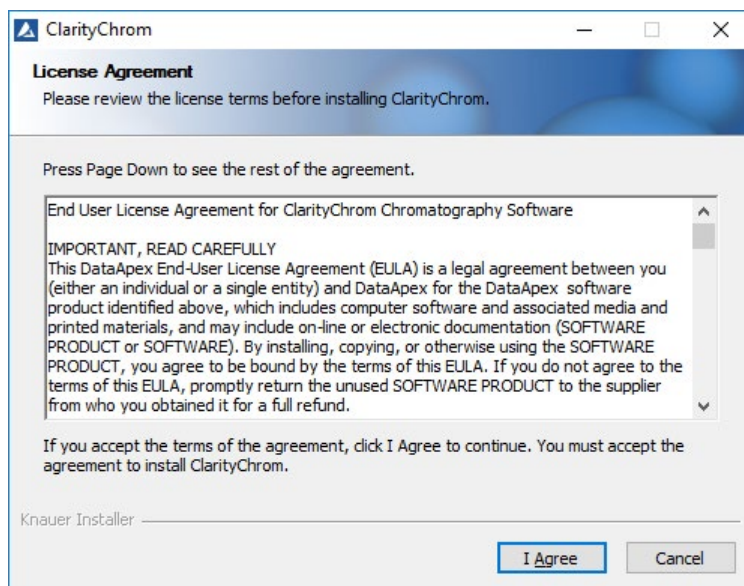
In case your DVD drive has no AutoPlay, please execute the file CDInstaller on the ClarityChrom® DVD via your file manager, e. g. Windows explorer. You will be guided through the installation. By clicking *NEXT*> you go to the next window. By clicking <*BACK* you go back to the previous window. At any time, you can interrupt the installation by clicking on *CANCEL*.

To install ClarityChrom®, click on *INSTALL* ClarityChrom Software. The first window of the installation routine is opened. Select the language. You can change the language in the software later as well.



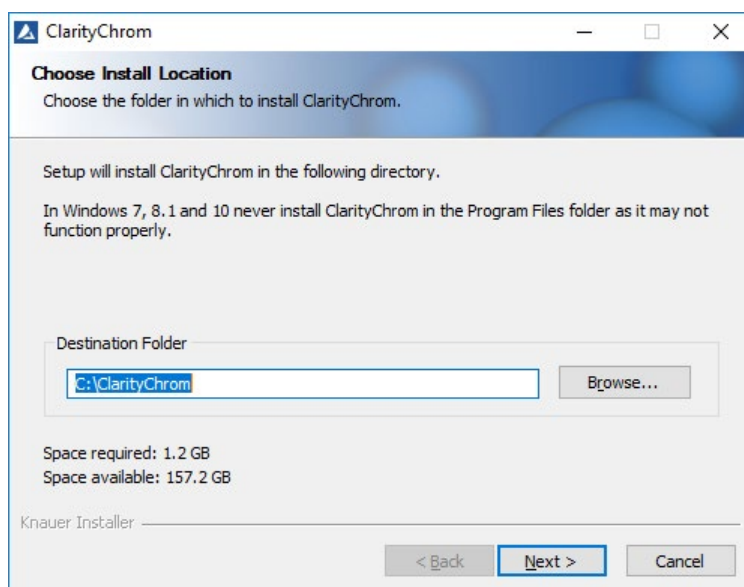
**Fig. 2:** Installation, language

The next window displays the license agreement of the software.



**Fig. 3:** Installation, license agreement

The license agreement must be accepted with a click on *I AGREE*. If you do not agree with the license conditions, you are not allowed to install the software. The next window displays the destination folder for the software installation.



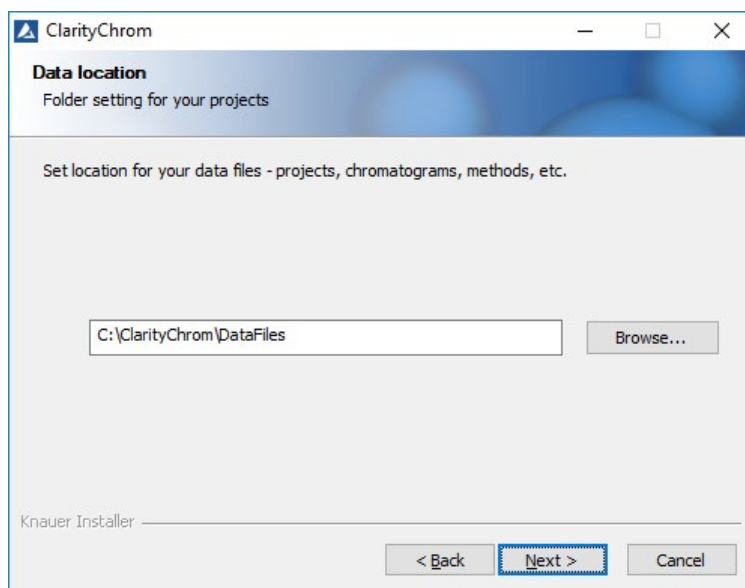
**Fig. 4:** Installation, selecting the destination folder

ClarityChrom® suggests the destination folder `C:\CLARITYCHROM`. Accept this path by clicking *NEXT*. If you want to set a different destination folder, click on *BROWSE* and select the path in the field *DESTINATION FOLDER*. All program files, examples, and help files will be saved there.



**Note:** If you are installing the software on Windows Vista or higher, do not use any subfolder in `C:\PROGRAM FILES`. Windows protects the Program Files folder and does not allow to change any installed file. Due to this protection, e.g. the configuration cannot be saved.

The next window displays the folder where the software should store the files. It is recommended to use the suggested path.

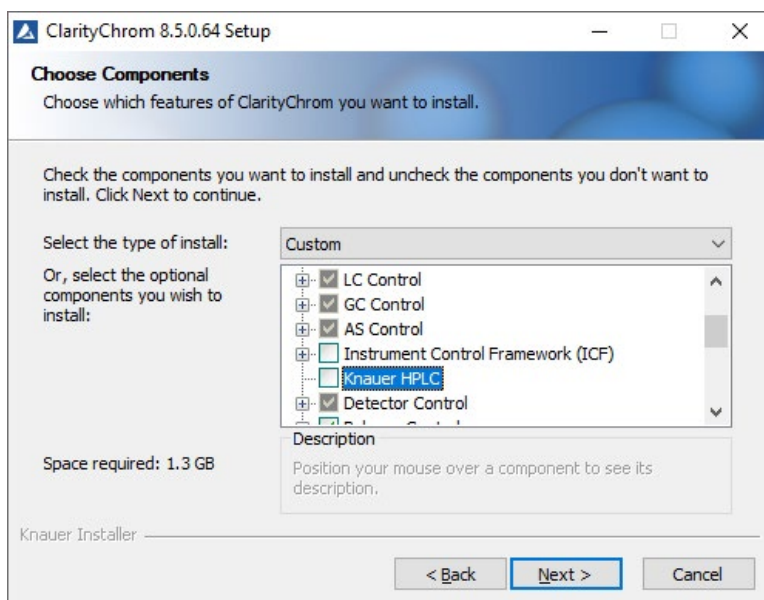


**Fig. 5:** Installation, choose data folder

Select the path where you want to store your data. If you would like to share the data in the network, you can select a network path. Make sure the folder is shared to allow other users to access the data.



**Note:** If you choose a network place, the access to network must be available at every time.



**Fig. 6:** Installation, choose program components

Deselect the check box *KNAUER HPLC*. The included Knauer drivers are outdated. The latest Knauer HPLC drivers, available on the installation medium, must be installed separately.



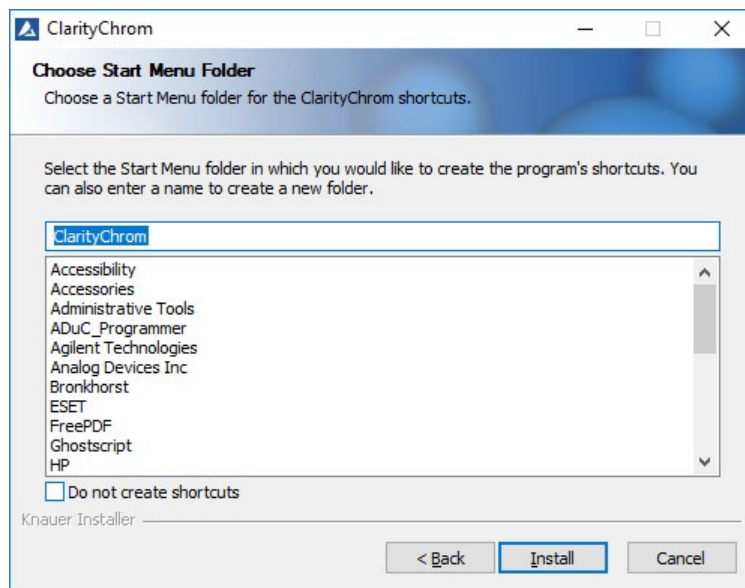


**Note:** In case you forgot to deselect the installation of the Knauer HPLC drivers, the drivers must be uninstalled after ClarityChrom® installation is finished. In the Windows control panel select the entry *CLARITYCHROM - C:\PROGRAM FILES (X86)\KNAUER\CLARITYCHROM* and press *UNINSTALL*. If uninstalled, install the latest driver from the installation medium.



**Note:** You shouldn't install the Agilent ICF drivers if you do not plan to control such a device. The Agilent ICF could make the computer system instable and could cause software crashes.

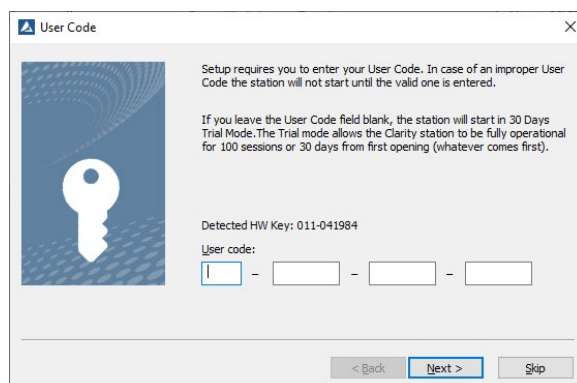
The next window *CHOOSE START MENU FOLDER* suggests the start menu folder names ClarityChrom. You can select another name. The name is independent of the path for the program files.



**Fig. 7:** Installation, start menu

If installation is running, as a part of the ClarityChrom® installation Microsoft visual C++ redistributable will be installed. Do not cancel this installation. It is required to run ClarityChrom® properly later on.

Enter the user code of your license dongle. You find the user code on the ClarityChrom® certificate in the software packing.



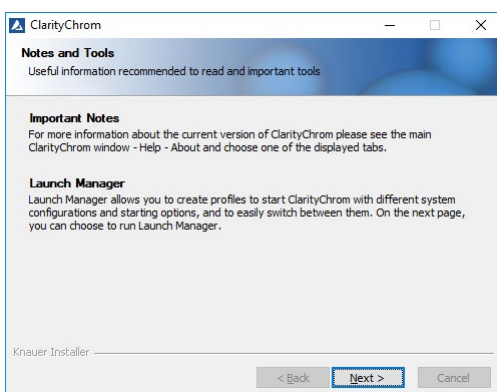
**Fig. 8:** Installation, user code

The installer may ask you to install different drivers, as for the USB license dongle and Data Apex A/D converters. You must allow the installer to install the drivers.



**Fig. 9:** Installation, Windows security window

The *NOTES AND TOOLS* window shows some additional information.



**Fig. 10:** Notes and tools

Click *NEXT* to proceed with the installation.



**Fig. 11:** Installation complete, reboot now

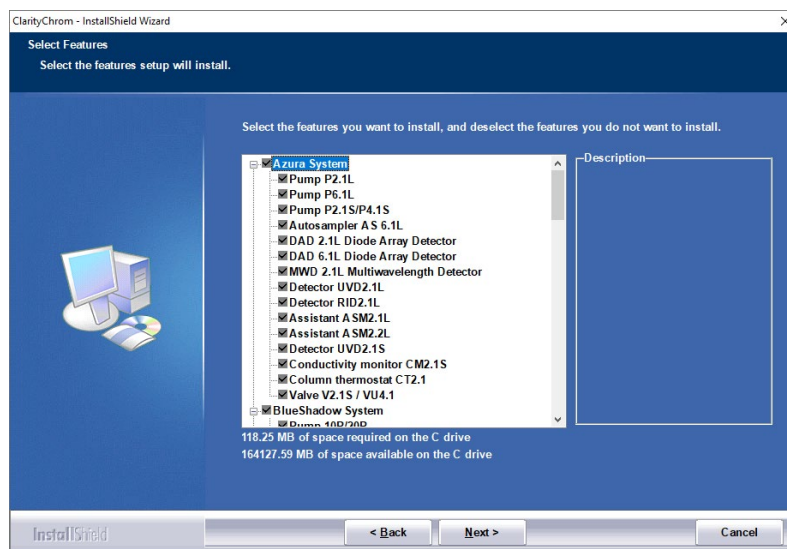
Click *FINISH* to complete the installation.

Install the KNAUER HPLC drivers. If you did not deselect the KNAUER HPLC drivers in the ClarityChrom® installation dialog, uninstall them from the Windows control panel.



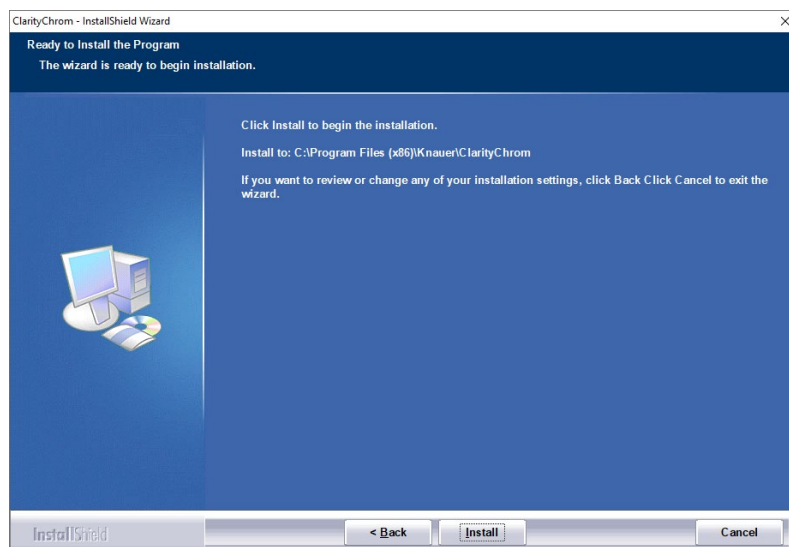
**Fig. 12:** Installation, main menu

Click on *INSTALL LATEST KNAUER DRIVERS* for starting the KNAUER driver installation. On the welcome screen, click *NEXT* to proceed.



**Fig. 13:** KNAUER driver installation, select features

The next screen shows for which modules the drivers will be installed. You cannot deselect a module.



**Fig. 14:** KNAUER driver installation, ready to install

**Next steps** The driver installation folder is shown:

- Click *INSTALL* button to install the KNAUER drivers.
- If the installation is finished, click the *FINISH* button to end the installation procedure.
- Connect your ClarityChrom® dongle to the computer.

**Result** ClarityChrom® software is ready to run.

### 3.3 Software upgrade

Upgrades are full versions. Before the upgrade can be installed, the installed software has to be uninstalled completely. We also recommend to remove the former ClarityChrom® installation folder to avoid problems with eventually existing files from the former installation. Before you remove the ClarityChrom® installation folder, store all you old data, as chromatograms, methods etc., in a safe place.

Use the installation instruction enclosed with the software.

As from version 6, ClarityChrom® uses a new data format for chromatograms. This format is not compatible with the format that has been used by former versions of ClarityChrom® (up to version 5). The new ClarityChrom® can convert chromatogram files from former versions and then open it. The converted files cannot be opened anymore by former ClarityChrom® versions. We recommend to make a backup of all chromatograms, acquired by former ClarityChrom® versions, before you open it in the new ClarityChrom®.

## 4. Program structure and control

This chapter gives you a brief introduction to the main principles of ClarityChrom®.



**Note:** For more detailed information refer to the reference and user manuals on the delivered DVD.

The ClarityChrom® station has a hierarchical structure. After startup, the main ClarityChrom® window will be displayed containing the symbols of the connected systems. After clicking on the chromatograph image and entering a user name, the instrument window will be displayed. This window is used for the data acquisition and manipulation of the connected chromatography system.



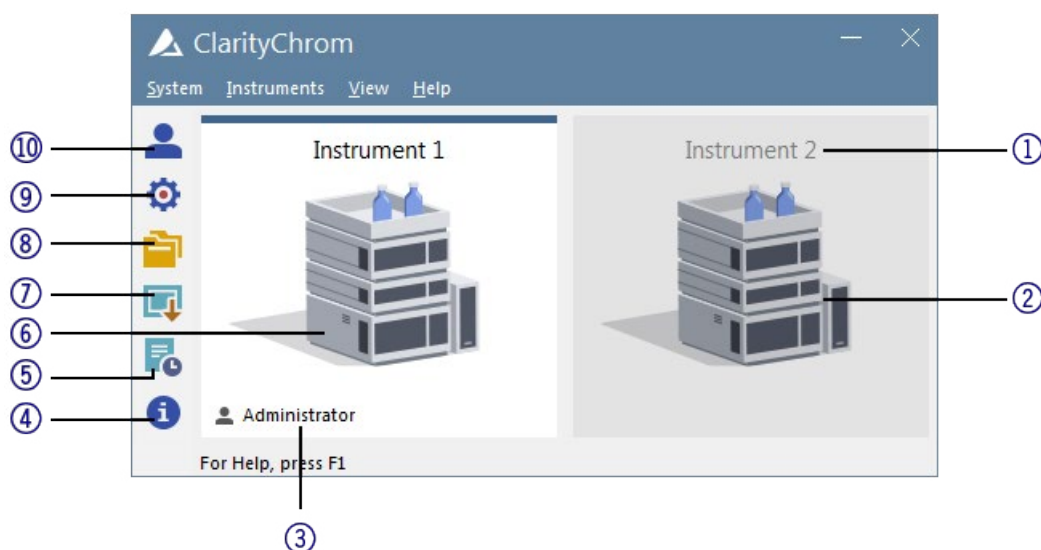
**Note:** The ClarityChrom® station works with systems that are called "instruments". All detectors that are connected to the same instrument will share a common time base.

### 4.1 ClarityChrom® main window

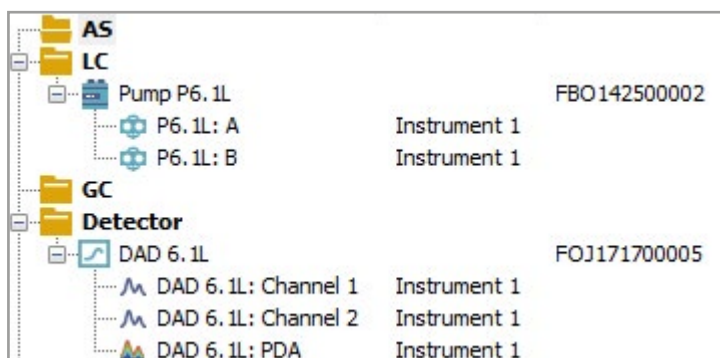
The ClarityChrom® main window is designed to set the station's configuration, selecting access rights and basic directories for data storage.

#### Legend


- |                                 |                                     |
|---------------------------------|-------------------------------------|
| ① Instrument name               | ⑥ Symbol of an activated system     |
| ② Symbol of a closed instrument | ⑦ Digital outputs                   |
| ③ User name                     | ⑧ Directories                       |
| ④ Info                          | ⑨ System configuration dialog       |
| ⑤ Audit trail                   | ⑩ User login dialog (User accounts) |




**Fig. 15:** ClarityChrom® main window



**Fig. 16:** System configuration dialog

The system configuration dialog (opened by the  icon or the menu sequence *SYSTEM · CONFIGURATION*) serves to specify the number of connected systems, their names, their corresponding instrument symbols and the type of the directly controlled devices.

The user login dialog (opened by the  icon or the menu sequence *SYSTEM · USER ACCOUNTS*) serves to administrate user names and passwords as well as specifying the respective individual rights for operation types (file access, modification of calibrations, integration parameters, etc.). Each user can adjust the appearance of the station.

## 4.2 The instrument window

The Instrument window measures and evaluates an analysis from a selected chromatography system. The window is displayed by clicking on the symbol of the relevant chromatography system in the main ClarityChrom® window. Depending on the number and type of configured devices being used, up to four independent instrument windows can be displayed simultaneously.



**Note:** The ClarityChrom® station must be set with as many instruments as you want to measure independent analyses.

Each instrument window contains an information table, status line and scheme of data processing. The different software modules, as method setup, sequence table or chromatogram window, appear in an own window and are shown as an own program in the Windows task bar.

Windows are distinguished by line color in the scheme and by the instrument name in the window header.

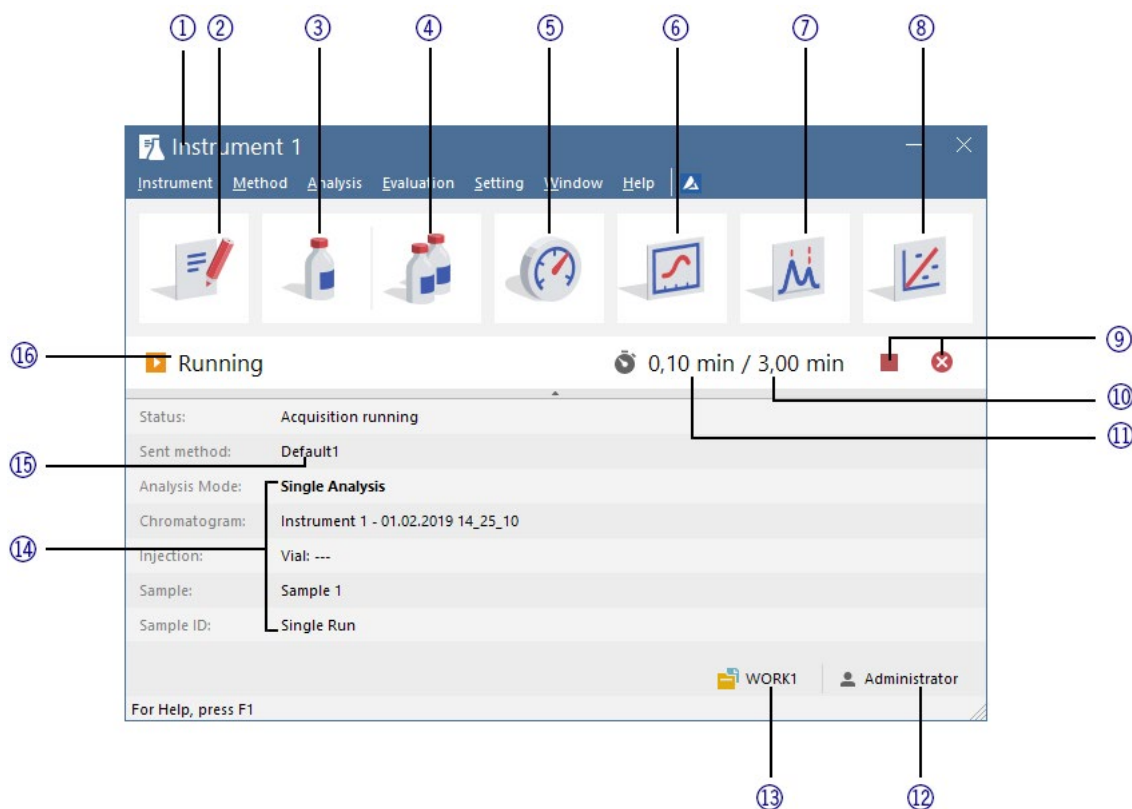
All dialogs that enable the performance of actions that may be required on a given instrument can easily be displayed from the instrument window by clicking the corresponding icons in the scheme or using commands from the menu.



**Note:** Sometimes it might happen that you cannot open any other window or the station will not react to your commands. This happens when working with what is known as, "modal windows". A modal window is a window that, while opened, forbids work to be performed in any other window, particularly windows which are used to select files, set parameters, etc.

**Legend**

- |  |  |
|--|--|
| ① Instrument name                              | ⑨ Button for single run, start sequence, stop run, abort |
| ② Method setup                                 | ⑩ Total run time   |
| ③ Single analysis start/stop (SINGLE ANALYSIS) | ⑪ Run time of current run (TIME)                         |
| ④ Sequence window (SEQUENCE)                   | ⑫ User name  |
| ⑤ Device status display and direct control     | ⑬ Project name   |
| ⑥ Data acquisition window (DATA ACQUISITION)   | ⑭ Information table                                      |
| ⑦ Chromatogram window (CHROMATOGRAM WINDOW)    | ⑮ Method name  |
| ⑧ Calibration window (CALIBRATION WINDOW)      | ⑯ Status display   |



**Fig. 17: Instrument window**



## 4.3 The chromatogram window



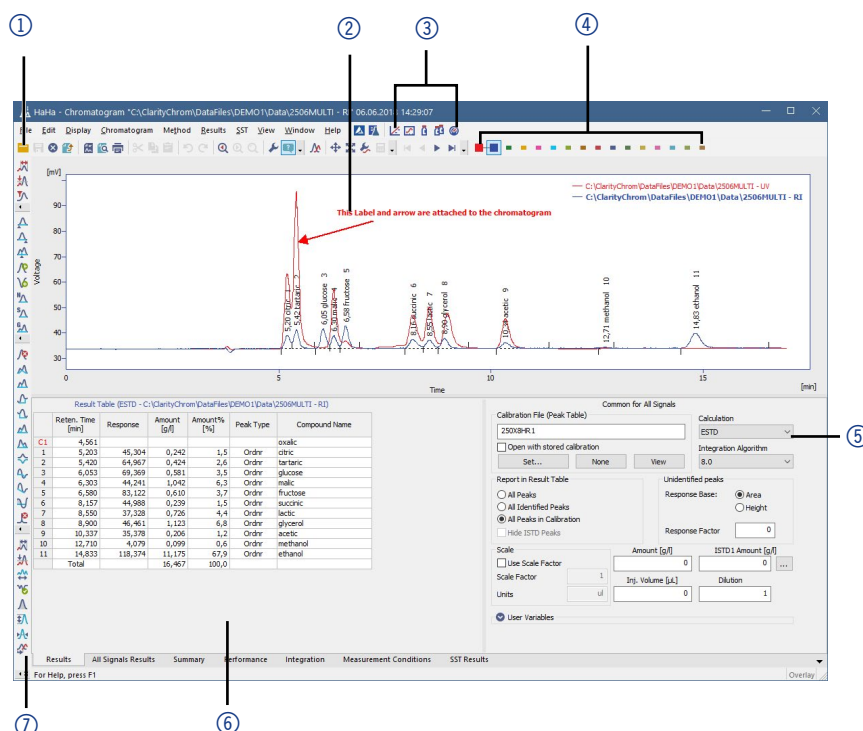
**Fig. 18:** Button for opening the chromatogram window  
(CHROMATOGRAM WINDOW)

The *CHROMATOGRAM WINDOW* window is the central window (opened by clicking the  icon) for displaying, modifying and evaluating chromatograms. Use the  icon to open one of the chromatograms.

The results table for a selected chromatogram can be found in the *RESULTS* tab. If it is not automatically displayed, click on the label of the *RESULTS* tab in the bottom-left corner of the window or use the *RESULTS · RESULT TABLE* command.

### Legend

- ① Chromatogram selection
- ② User legend
- ③ Switching to other windows
- ④ Multiple detectors/chromatograms
- ⑤ Selecting the calculation method
- ⑥ Results table
- ⑦ Chromatogram modification



**Fig. 19:** Chromatogram window



## 4.4 The calibration window



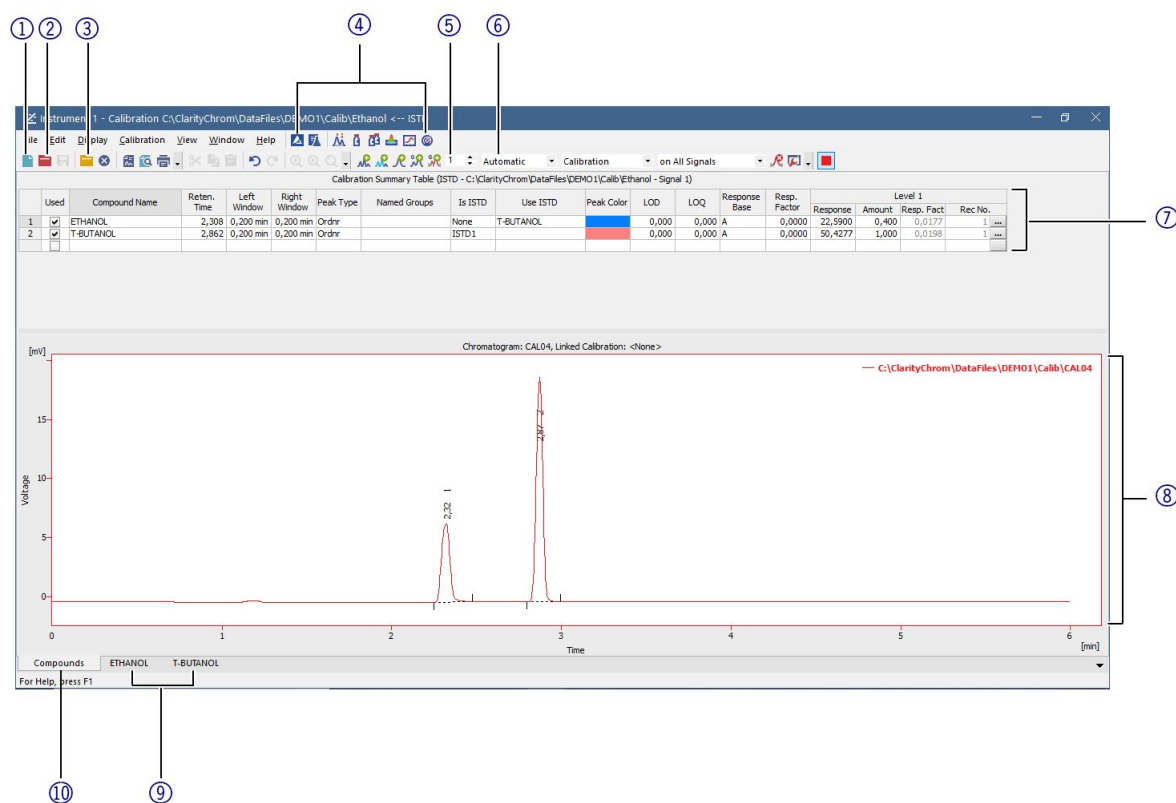
**Fig. 20:** Button for opening the calibration window (*CALIBRATION WINDOW*)

The Calibration window is used for creating, modifying and displaying calibration curves.

The global calibration table and calibration standard chromatogram are located in the *COMPOUNDS* tab.

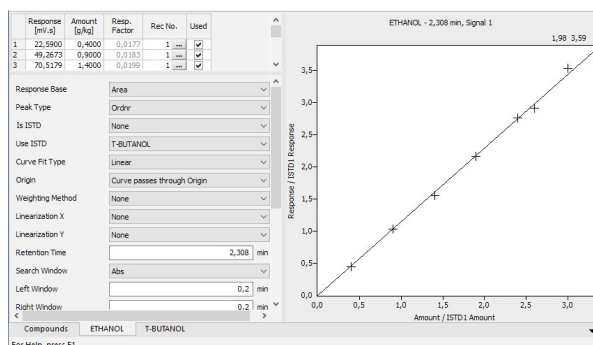
### Legend

- |                                       |  |
|---------------------------------------|--|
| ① New calibration                     | ⑦ Global calibration table               |
| ② Open calibration                    | ⑧ Name of the calibration                |
| ③ Open standard                       | ⑨ Calibration data of the compound       |
| ④ Link to other ClarityChrom® windows | ⑩ Global calibration table and standards |
| ⑤ Level selection                     |  |
| ⑥ Type selection                      |  |



**Fig. 21:** Calibration window

Switch to the tab with the name of the compound to display its calibration curve.



**Fig. 22:** Calibration curve window

## 4.5 The sequence window



**Fig. 23:** Button for opening the sequence window (*SEQUENCE*)

The sequence window is used to define the sequential measurement of multiple samples.

Measurements are done individually in the table by row. Each row can define the way multiple samples are measured using the same method for multiple samples and/or by taking multiple injections of one sample.

Status	Run	SV	EV	I/V	Sample ID	Sample	Sample Amount	ISTD1 Amount	Sample Dilut.	Inj. Vol. [µL]	File Name	Sample Type	Lvl	Method Name	Report Style	Open	Open Calib.	Print
<input checked="" type="checkbox"/>	1	1	1	1	blank		0,000	0,000	1,000	2,000	Blank	Blank	1	Ethanol in blood	Calibration	<input checked="" type="checkbox"/>	<input checked="" type="checkbox"/>	<input checked="" type="checkbox"/>
<input checked="" type="checkbox"/>	2	2	2	1	std1	0,4	0,000	0,000	1,000	2,000	Cal204	Standar	1	Ethanol in blood	Calibration	<input checked="" type="checkbox"/>	<input checked="" type="checkbox"/>	<input checked="" type="checkbox"/>
<input checked="" type="checkbox"/>	3	3	3	1	std2	0,8	0,000	0,000	1,000	2,000	Cal209	Standar	2	Ethanol in blood	Calibration	<input checked="" type="checkbox"/>	<input checked="" type="checkbox"/>	<input checked="" type="checkbox"/>
<input checked="" type="checkbox"/>	4	4	4	1	std3	1,4	0,000	0,000	1,000	2,000	Cal214	Standar	3	Ethanol in blood	Calibration	<input checked="" type="checkbox"/>	<input checked="" type="checkbox"/>	<input checked="" type="checkbox"/>
<input checked="" type="checkbox"/>	5	5	5	1	std4	1,9	0,000	0,000	1,000	2,000	Cal219	Standar	4	Ethanol in blood	Calibration	<input checked="" type="checkbox"/>	<input checked="" type="checkbox"/>	<input checked="" type="checkbox"/>
<input checked="" type="checkbox"/>	6	6	6	1	std5	2,4	0,000	0,000	1,000	2,000	Cal224	Standar	5	Ethanol in blood	Calibration	<input checked="" type="checkbox"/>	<input checked="" type="checkbox"/>	<input checked="" type="checkbox"/>
<input checked="" type="checkbox"/>	7	7	7	1	std5	2,6	0,000	0,000	1,000	2,000	Cal226	Standar	6	Ethanol in blood	Calibration	<input checked="" type="checkbox"/>	<input checked="" type="checkbox"/>	<input checked="" type="checkbox"/>
<input checked="" type="checkbox"/>	8	8	8	1	0442		0,000	0,000	1,000	2,000	Pers01A	Unknown		Ethanol in blood	Chromatogram	<input checked="" type="checkbox"/>	<input checked="" type="checkbox"/>	<input checked="" type="checkbox"/>
<input checked="" type="checkbox"/>	9	9	9	1	0445		0,000	0,000	1,000	2,000	Pers01B	Unknown		Ethanol in blood	Chromatogram	<input checked="" type="checkbox"/>	<input checked="" type="checkbox"/>	<input checked="" type="checkbox"/>

**Fig. 24:** Sequence window

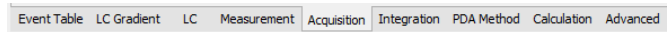
Both an active and a passive operation are possible. An active sequence means that the station controls both the startup and duration of individual analyses. If an autosampler is integrated into the system, use an active sequence. In a passive sequence, they are controlled in stand-alone mode by the chromatography system or the autosampler.

### 4.5.1 Active sequence:

- increases the reliability of mutual synchronization between ClarityChrom®, the autosampler and the chromatography system.
- is required when controlling selected autosamplers through the AS control module.
- requires the interconnection of a control signal from the ClarityChrom® station to the autosampler.

## 4.6 Method setup

The parameters for determining and describing the conditions for measuring and evaluating are set in the method setup dialog. These settings are saved in the template method file.



**Fig. 25: Method setup dialog tabs**

The method setup is accessible from the instrument window by click on the method setup icon.



**Fig. 26: Method icon**

The setup for the KNAUER devices is described in chapter 8.

## 5. First analyses

This chapter illustrates an exemplary model analysis that is designed to help demonstrate basic practical work procedures with the ClarityChrom® station. Naturally however, this model does not address all of the stations capabilities.

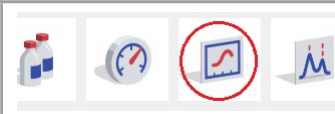
### 5.1 Program start

One of the ClarityChrom® station's key advantages is its ability to measure immediately without having to make any lengthy preparation or settings. The only requirement is that your system is already configured.

- Click the desktop icon or select *START · (PROGRAMS) · CLARITYCHROM · CLARITYCHROM CHROMATOGRAPHY STATION* to start the program.
- Click on the image of the HPLC system or on the login button to open the instrument window.

You can immediately run an analysis measurement by clicking *SINGLE ANALYSIS*, send method if no method is already send and then *RUN* in the instrument window. However, in this procedure, we will first explain certain functions before moving on to the measurement.

#### 5.1.1 Signal recording




Process	Figure
<ol style="list-style-type: none"> <li>1. Click on the data acquisition window to display the current signal from detectors and check for drift and noise.</li> <li>2. Close the window by clicking <i>x</i> or by clicking <i>FILE · EXIT</i>.</li> </ol>	

#### 5.1.2 Measurement and evaluation parameters

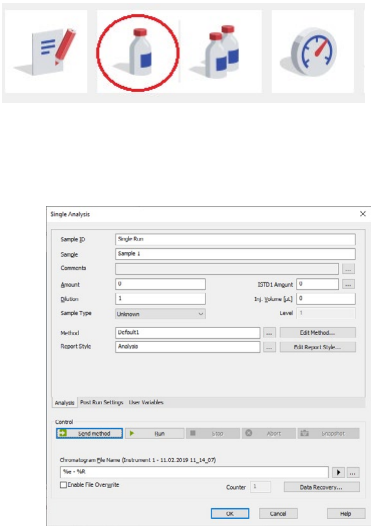
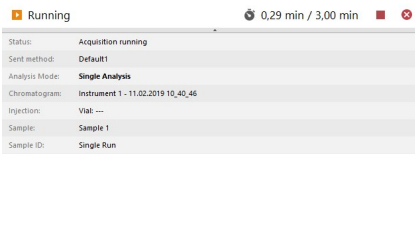
Certain parameters (voltage range, sampling rate etc.) must be set prior to measurement.






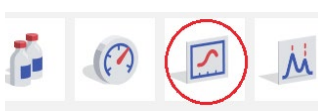
**Note:** Making changes during measurement would yield invalid results. Therefore the parameters are blocked during the ongoing analysis.

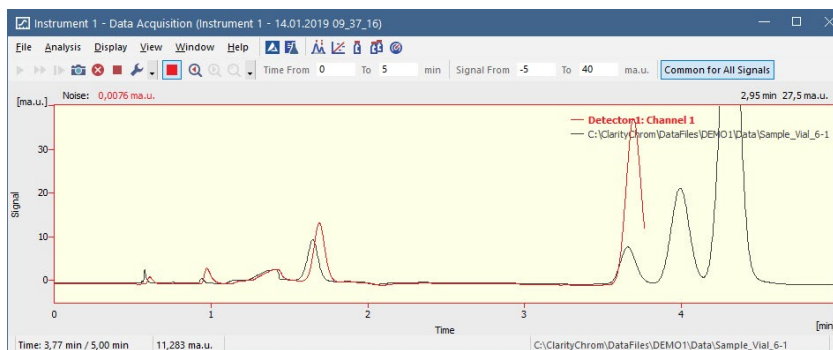
Process	Figure
<ol style="list-style-type: none"> <li>1. A click on the method setup icon will open the method setup dialog.</li> <li>2. A new method can be created by clicking on the new method icon  or open an existing method by click on the open icon  .</li> </ol>	

### 5.1.3 Analysis process

Process	Figure
<p>1. Click on <i>SINGLE ANALYSIS</i> to open the single analysis dialog and enter the title of the analysis.</p>	 <p><b>Fig. 27: Single analysis dialog</b></p>
<p>2. Run the analysis using the <i>RUN</i> command. During the run, the current measurement time and the <i>RUNNING</i> inscription will be displayed in the instrument window in the status bar below the scheme. The <i>RUN</i> button will be active, if the method is already sent to the instrument</p>	

### 5.1.4 Analysis recording

Process	Figure
<p>1. Click on the data acquisition window to display the analysis procedure again.</p> <p>2. Left click the mouse button and drag to select the area to be magnified, then release the button. The original display can be returned by clicking the  icon or by double-clicking the left mouse button within the graph area. To change to the previous zoom press . To change to the next zoom press .</p>	



**Fig. 28:** Data acquisition window

Data acquisition can be controlled using following icons:



The measured chromatogram can be compared to an already completed chromatogram, e.g. solvent, calibration standard, etc.

There are two ways to do this:

1. The *FILE · SET BACKGROUND CHROMATOGRAM* command selects, which chromatogram is to be displayed in the background.
2. The *FILE · SHOW SUBTRACTION CHROMATOGRAM* command displays the automatically subtracted chromatogram defined in the method setup - Measurement dialog.



**Note:** The chromatogram in the background will only be displayed during data acquisition.

### 5.1.5 Chromatogram display and evaluation

Process	Figure
<p>1. The completed analysis will automatically be displayed in the chromatogram window if „<i>OPEN CHROMATOGRAM WINDOWS</i>“ is selected at the post run settings for single analysis.</p>	
<p>2. Every saved chromatogram can be selected and opened by clicking <i>OPEN CHROMATOGRAM</i> in the chromatogram window.</p>	
<p>3. Just as in the window for signal monitoring, any section of the chromatogram can be zoomed to by left clicking, dragging to select the area and then releasing the mouse button.</p>	

### 5.1.6 Calibration



**Fig. 29:** Button for opening the calibration window

The creation and use of calibration curves is an extensive part of the ClarityChrom® station. Calibration curves created from calibration standards are saved in separate calibration files. Each file can contain a virtually unlimited number of curves, which then can be calibrated at up to twenty concentration levels.

Calibrated results are obtained by creating calibration curves and saving them in a calibration file. Subsequently, a calibration file is linked to a chromatogram, and the required type of calculation (external or internal standard) is set.

## 6. Mobile Control with ClarityChrom®

The monitor mode in Mobile Control is no longer supported by technical reasons.



**Note:** Make sure that Mobile Control is closed before you start ClarityChrom®.

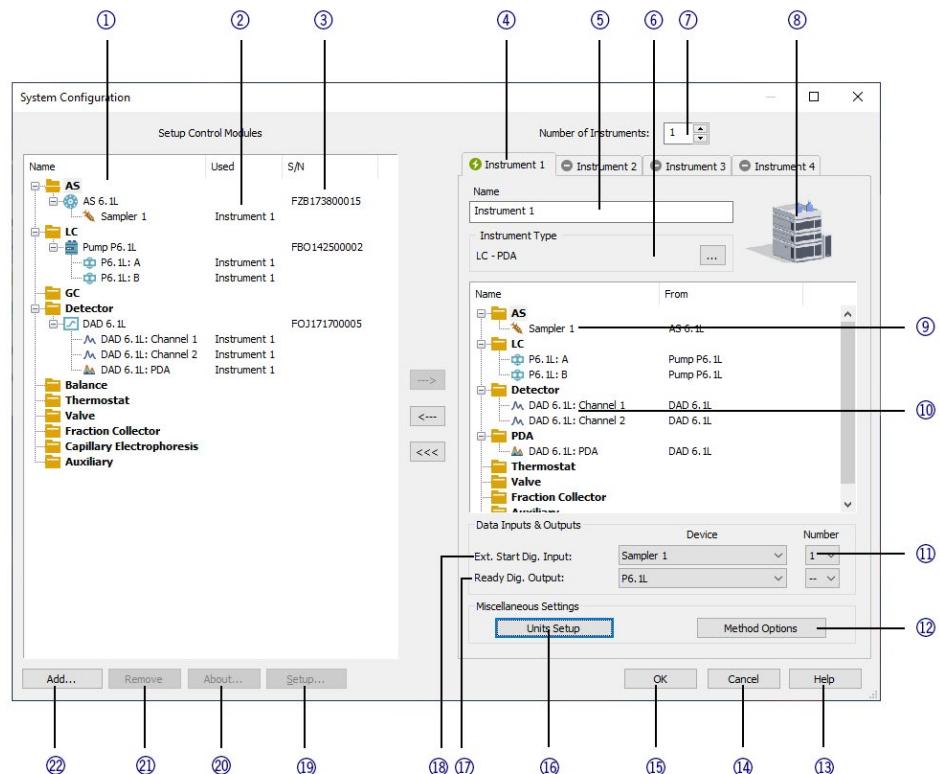
## 7. Configuration – systems and devices

For a detailed description of the configuration, refer to chapter 1.1.3 - Configuration of the enclosed „Clarity Reference guide“. The setup and configuration must be performed in different steps.

First, all necessary devices have to be configured. The devices appear on the left panel („Setup Control Modules“) of the System Configuration window.

### Legend

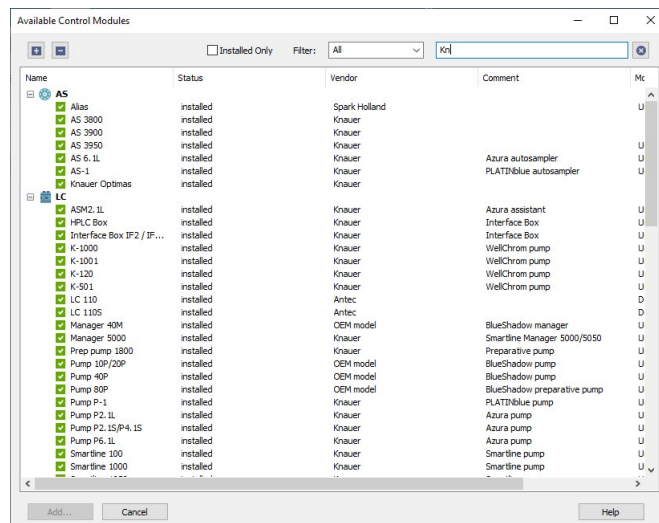
- |  |   |
|--|---|
| ① Configured devices   | ⑫ <i>METHOD SENDING OPTIONS</i>                                   |
| ② Instrument number after the device has been assigned.          | ⑬ Help ( <i>HELP</i> )  |
| ③ Device serial number   | ⑭ Cancel configuration ( <i>CANCEL</i> )                          |
| ④ Instrument tab   | ⑮ Save configuration ( <i>OK</i> )                                |
| ⑤ Instrument name ( <i>NAME</i> )                                | ⑯ <i>UNITS SETUP</i>  |
| ⑥ Instrument type ( <i>INSTRUMENT TYPE</i> )                     | ⑰ Ready output device ( <i>READY OUTPUT</i> )                     |
| ⑦ Number of instruments ( <i>NUMBER OF INSTRUMENTS</i> )         | ⑱ Start input device ( <i>EXT. START DIG. INPUT</i> )             |
| ⑧ Image for instrument   | ⑲ Device setup ( <i>SETUP..</i> )                                 |
| ⑨ Device name ( <i>INTEGRATION</i> )                             | ⑳ Information about device and driver versions ( <i>ABOUT..</i> ) |
| ⑩ Device section assigned to the selected instrument             | ㉑ Remove device ( <i>REMOVE</i> )                                 |
| ⑪ Number of the digital device input or output ( <i>NUMBER</i> ) | ㉒ Add device ( <i>ADD..</i> )                                     |



**Fig. 30:** System configuration window



For this purpose, click on *ADD* to open the list of available control modules. The modules are arranged in groups which can be displayed separately. For example, for an HPLC system you need the pump out of the LC group and a detector out of the detector group. Each device must be configured separately.



**Fig. 31:** Lists of available control modules filtered by "All - Kn(auer)"

Double click on the desired module or select it and click on *ADD...* to open the corresponding configuration window. The configuration window and its corresponding options are described along with the configuration dialogs of each device further down.

Complete the configuration dialog and click on *OK* to return to the system configuration window.

For each device a serial number must be entered, otherwise the configuration dialog cannot be finished. The *FILTER* allows you to limit the view to certain devices. As an example, selecting the filter *ALL* and entering Knauer („Kn“ is sufficient) will limit the view to those devices for which KNAUER is tagged as the device or driver manufacturer. Alternatively, the device name or a part of a name can be entered, e.g. 2.1L, to show only those devices whose name contains.

## 7.1 Configuration - device communication port

Some of the devices have two communication ports on the rear panel for controlling the device by the computer. One is an RS-232 port, also called serial or COM port; the other is an ethernet port, also called LAN (Local Area Network). Beside the KNAUER valve drives, for all the devices the desired communication port must be defined in the device. The functionality may be limited when choosing the serial port. Please pay attention to the notes in the section on device configuration further down.

Device drivers of devices with a serial port only support one baud rate for the ClarityChrom® workstation. Please pay attention to the notes in the section on device configuration further down.

Many devices, which have a LAN interface, have the possibility to choose if the device obtains its IP address from an DHCP server (LAN DHCP), e.g. a router, or if the device obtains a fixed IP address (LAN manual). The choice between these two options depends on your network configuration.

Although the KNAUER detector Smartline 2600 has an additional USB or LAN port, this port is not functional; the device has to be controlled via the serial interface.

Please pay attention to the corresponding notes in this manual and refer to the device's manual for more information on how the desired communication port must be configured. Please note, that for some devices the functionality depends on the selected communication port.

## 7.2 Connections for device control from PC via LAN



**Note:** HPLC devices made by KNAUER work only with IP addresses which are assigned via IPv4. IPv6 is not supported.



**Note:** KNAUER devices require IP port 10001 to be opened in security software, as antivirus software or firewall. The autosamplers AS 3950 and AZURA® AS 6.1L additionally use IP ports 80, 2101 and 2362.

This section describes how to set up an HPLC system in a local area network (LAN) and how a network administrator can integrate this LAN into your company network. The description applies to the operating system Windows and all conventional routers.



**Note:** To set up a LAN, we recommend to use a router. That means the following steps are required:

- Process**
1. On the computer, go to the control panel and check the LAN properties.
  2. Hook up the router to the devices and the computer.
  3. On the computer, configure the router to set up the network.
  4. Install the chromatography software from the data storage device.
  5. Switch on the device and run the chromatography software.

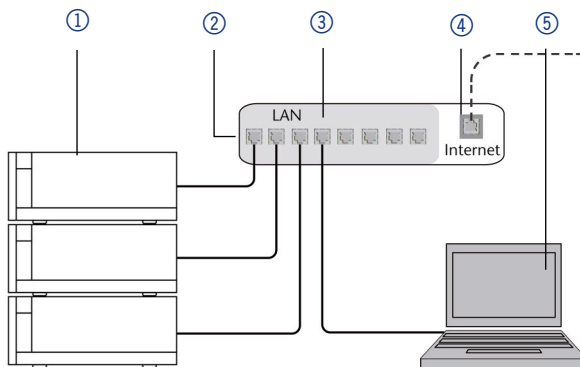
### 7.2.1 Configuring the LAN settings

**Prerequisite** The LAN uses only one server (which is normally the router) from that the devices automatically receive their IP address.

- In Windows, power saving, hibernation, standby, and screen saver must be deactivated.
  - In case you use an USB-to-COM box, the option *ALLOW THE COMPUTER TO TURN OFF THE DEVICE TO SAVE POWER* in the device manager must be deactivated for all USB hosts.
  - Windows 7 and higher: For the network adapter, the option *ALLOW THE COMPUTER TO TURN OFF THIS DEVICE TO SAVE POWER* in the device manager must be deactivated.
1. Run *CONTROL PANEL > NETWORK AND SHARING CENTER*.
  2. Double-click on *LAN CONNECTION*.
  3. Click on the button *PROPERTIES*.
  4. Select *INTERNET PROTOCOL VERSION 4 (TCP/IPv4)*.
  5. Click on the button *PROPERTIES*.
  6. Check the settings in the tab *GENERAL*. The correct settings for the DHCP client are:
    - a) Obtain IP address automatically
    - b) Obtain DNS server address automatically
  7. Click on the button *OK*.

## 7.2.2 Connecting the cables

A router ③ has several LAN ports ② and one WAN port ④ that can be used to integrate the LAN into a wide area network (WAN), e.g. a company network or the Internet. In contrast, the LAN ports serve to set up a network from devices ① and a computer ⑤. To avoid interference, we recommend operating the HPLC system separately from the company network.



You will find patch cables for each device and the router in the accessories kit. To connect the router to a WAN, an additional patch cable is required, which is not supplied within the scope of delivery.

**Prerequisite** ■ The computer has been switched off.

■ There is a patch cable for each device and the computer.

- Process**
1. Use the patch cable to connect the router and the computer. Repeat this step to connect all devices.
  2. Use the power supply to connect the router to the mains power system.

## 7.2.3 Configuring the router

The router is preset at the factory. You will find a label at the bottom side of the router, on which IP address, user name, and password are printed. These informations help to open the router configuration.

**Prerequisite** 1. To open the router configuration, start your Internet browser and enter the IP address (not for all routers).

2. Enter user name and password.

3. Configure the router as DHCP server.

4. In the router configuration, check the IP address range and make changes if necessary.

**Result** Once the router has assigned IP addresses to all devices, the chromatography software can be used to remotely control the system.

## 7.2.4 Integrating the LAN into a company network

A network administrator can integrate the LAN into your company network. In this case you use the WAN port of the router.



**Prerequisite** There is a patch cable for the connection.

- Process**
1. Check that the IP address range of the router and of the company network do not overlap.
  2. In case of an overlap, change the IP address range of the router.
  3. Use the patch cable to connect the router WAN port to the company network.
  4. Restart all devices, including the computer.

## 7.2.5 Troubleshooting LAN

Go through the following steps, in case no connection between the computer and the devices can be established. Check after each step if the problem is solved. If the problem cannot be located, call the Technical Support.


1. Check the status of the LAN connection in the Windows task bar:


-  Connected
-  Connection not established

If no connection was established, test the following:

- Is the router switched on?
- Is the patch cable connected correctly to the router and the computer?
2. Check the router settings:
  - Is the router set to DHCP server?
  - Is the IP address range sufficient for all the connected devices?
3. Check all connections:
  - Are the patch cable connected to the LAN ports and not the WAN port?
  - Are all cable connections between devices and router correct?
  - Are the cables plugged in tightly?
4. If the router is integrated into a company network, pull out the patch cable from the WAN port.
  - Can the devices communicate with the computer, even though the router is disconnected from the company network?
5. Turn off all devices, router, and computer. Firstly, switch on the router and wait until its self-test is finished. Secondly, switch on the devices and the computer.
  - Has this been successful?
6. Replace the patch cable to the device with that no connection could be established.
  - Has this been successful?
7. Make sure that the IP port of the device matches the port in the chromatography software.

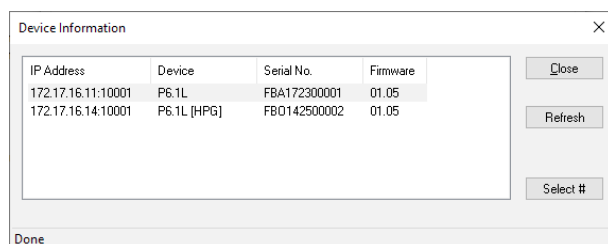
## 7.3 Configuration by downloading from the device

For nearly all KNAUER devices the configuration can be read-out and transferred (download) into the configuration window using the  button.

This proceeding is highly recommended to avoid typos and other problems, while a device is configured manually. Select the used interface and click on  . In this window all connected devices from the same model type will be listed. If the device is connected via RS-232, normally just one device will be displayed; via LAN several devices may be shown.

As an example, in an HPG system consisting of 2 pumps P6.1L, which are both controlled via LAN, both pumps are displayed. Select the device you want to add and click on *SELECT #* to read out the configuration data of the selected device and download the information into the configuration window. Please note that devices have to be named differently in the configuration.

If you use two devices of the same model, at least one device name has to be changed because the default name is identical for both devices.



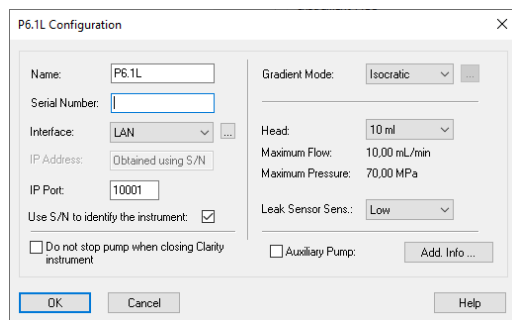
**Fig. 32:** Device information window with 2 pumps model P 6.1L

## 7.4 Configuration - KNAUER pumps

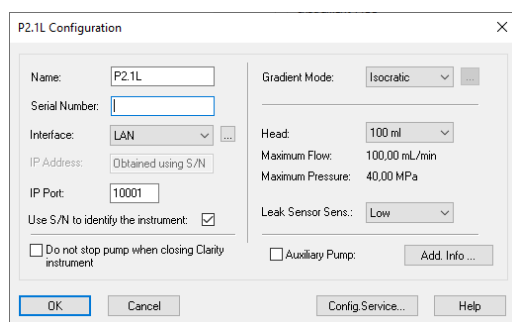
The following KNAUER pumps are supported by ClarityChrom®:

- AZURA® P 6.1L and P 2.1L
- AZURA® P 2.1S/P 4.1S
- PLATINblue P-1
- Smartline Pumps S 1050, S 1000, S 100, Preparative Pump 1800
- WellChrom Pumps K-1800, K-1001/ K-1000, K-501, and K-120.

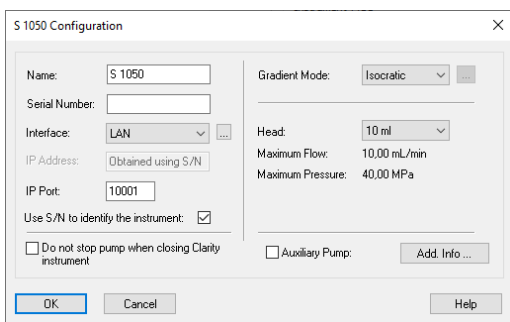
Note that during the setup of the pump, the interface over which the device should be controlled is selected. The interface should match the interface defined in the software. Please pay attention to the device-specific notes below. In ClarityChrom® the isobar mode of the pump P 2.1L and the constant pressure mode of the pump P 6.1L are not supported.



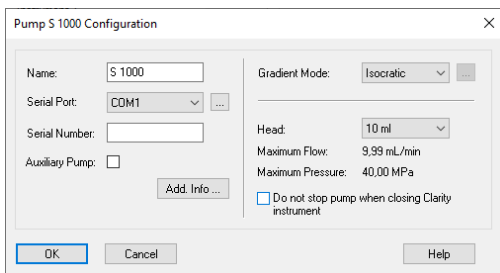
**Fig. 33:** Configuration window of the pump P 6.1L



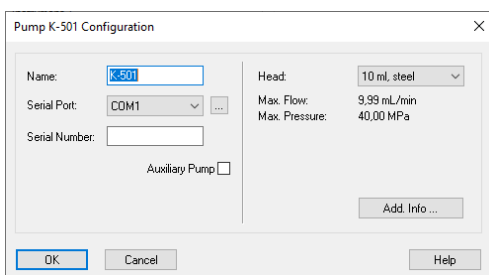
**Fig. 34:** Configuration window of the pump P 2.1L



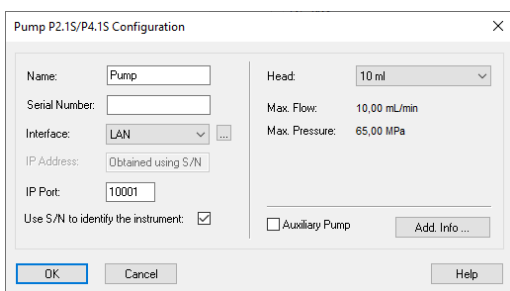
**Fig. 35:** Configuration window of the pump S 1050, P-1



**Fig. 36:** Configuration window of the pumps S 1000, K-1001/K-1000, 1800



**Fig. 37:** Configuration window of the pumps K-501/K-120



**Fig. 38:** Configuration window of the pump S 100, P 2.1S/ P4.1S



**Note:** To drive pumps in serial mode, the appropriate settings have to be made in the pump menu (i.e. on the pump itself). Follow the hints in the section „Serial Port“.

**Configuration**

**NAME:** The default pump name will be suggested automatically by selecting the pump type. Enter a descriptive name for the KNAUER interface device. This name will appear on the LC tab when the instrument setup or status windows are displayed.



**Note:** Use a name which is unique within the instrument (configuration). It is not allowed to configure two devices in an instrument with the same name, e.g. 2 x "S 1000" for a binary HPG system.

**Configuration** *SERIAL PORT*: From the drop-down list, select the serial port on your PC where your pump is connected.



**Note:** For error-free operation of the binary KNAUER net, every device should be connected to an own COM port. However, connecting two pumps to the same COM port using the y-cable may result in communication problems.




**Note:** If the pumps S 1050, P-1 should be controlled by RS-232, in the pump's own setup the *INTERFACE* must be set to *RS232 115200*.

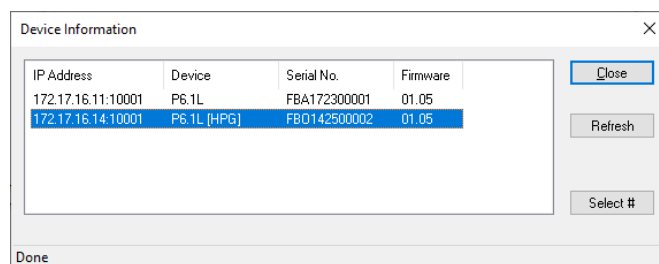


**Note:** The pumps K-1000, K-1001, S 1000 and K-1800 (preparative pump 1800) only are controlled with ClarityChrom® if the pump's internal communication in the menu option *CONTROL* is set to *NET BAUD RATE 9600*.



**Note:** To control a pump K-501, the menu option *CONTROL* must be set to *EXT:RS232* in the pump's internal setup. The firmware version must be v. 1.23 or higher.

Click the  button to get a list of the devices connected to the selected interface. If one or more devices have been found, click on a device and on the *SELECT #* button. The corresponding configuration information, e.g. the serial number, are read out by the device.




**Fig. 39:** Device information dialog

Click on *REFRESH* to update the list, e.g. if a connected and switched-on device has not been found.

Click on *SELECT #* to select a device. The serial number as well as any additional information for the selected device will then be automatically entered into the configuration dialog. In this case you must not enter the configuration data manually.

When complete, click *CLOSE* to exit the dialog and return to the system configuration window.

*INTERFACE* (only valid for pumps P 2.1L, P 6.1L, P-1, S 1050, S 100, P 2.1S/P 4.1S, 10P/20P)

*INTERFACE: [...]*: Click the  button to get a list of all devices (pumps, detectors, etc.) which can be accessed via the selected interface (Fig. 32 on page 32). Select a device and click on *SELECT #* to confirm. The device information window allows for the configuration information to be read directly from the connected instruments.

The Smartline pumps S 1050 and P-1 as well as the micro pumps support two types of communication interfaces: RS-232 and LAN (Local Area Network). The settings for these interfaces are different:

The image shows two side-by-side screenshots of a software configuration window. The left screenshot shows the 'Interface' dropdown set to 'RS-232', 'COM Port' set to 'COM3', and 'Baud Rate' set to '115200'. The right screenshot shows the 'Interface' dropdown set to 'LAN', 'IP Address' set to 'Obtained using S/N', 'IP Port' set to '10001', and the checkbox 'Use S/N to identify the instrument' checked.

**Fig. 40: Interface settings**

**Interface RS-232** *COM PORT:* From the drop-down list, select the serial port (COM port) on your PC where your pump is connected. For the pumps S 1000, K-1000/1001, and 1800 the COM port is labeled Network. This has to do with drivers. Network 1 equals COM 1 etc. By clicking on the  button, the software automatically recognizes the connected and switched-on device. This procedure is recommended. For the pump K-1001, follow the hints above concerning the firmware version: If the pump has a firmware version < 5.x (e.g. 4.01), it has to be configured as K-1000. The pumps P 2.1L and P 6.1L can only be accessed via LAN and the RS-232 option is not provided.

**Interface: LAN** *IP ADDRESS:* If the option *USE S/N TO IDENTIFY THE INSTRUMENT* is activated, this input field is grayed out. If you click on the  button, the software recognizes the connected and switched-on device automatically. This procedure is recommended. If you plan to use the device with a static IP address, the device can still be recognized by its serial number. If you want to set a static IP address, deactivate the option *USE S/N TO IDENTIFY THE INSTRUMENT*. Afterwards, the IP address input field is active. Please note that the static IP address has to be set in the pump itself as well. For detailed information refer to the pump's user manual. Please note that the pumps AZURA® P 2.1S, P 4.1S, and S 100 only support the allocation of IP addresses via DHCP; allocation of a static IP address is not possible.

*IP PORT:* The set IP port 10001 should not be changed. Otherwise, communication with the pump is not possible. The port 10001 is also set in the pump's setup. If it is necessary to use a different IP port, the IP port has to be changed in the device as well as in the software.

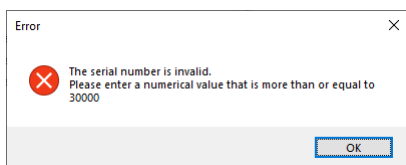
*USE S/N TO IDENTIFY THE INSTRUMENT:* This option is activated by default.




**Note:** We recommend the use of the option *USE S/N TO IDENTIFY THE INSTRUMENT* to obtain the IP address automatically, especially if a DHCP server (e.g. a router) is used. We highly recommend using the S/N and not the IP address to identify the instrument because devices may automatically receive a new IP address when reset. If a static IP address is used, the device can be recognized also by the serial number.


*SERIAL NUMBER:* Otherwise type in the serial number of the pump you are using. The serial number of network controlled pumps is used for the device identification and addressing during serial communications. Therefore, the serial number should match the serial number of the defined pump. Many pumps can be read out with the  button. That way the serial number and all necessary configuration settings are transferred. In this case, the serial number does not have to be entered manually.





**Fig. 41:** Error message for an invalid serial number

*GRADIENT MODE:* If the configuration information from the pump have been transferred using the  button, the correct gradient mode for the pumps P 6.1L, P 2.1L, P-1, S 1050, S 1000, Preparative Pump 1800, K-1001, or K-1000 is selected as set in the pump. Otherwise, select the desired gradient mode from the drop-down list. Note that the gradient mode also must be set correctly in the setup of the pump (pumps P 6.1L, P-1, S 1050, S 1000, Preparative Pump 1800, K-1001, and K-1000).

The gradient mode of the pump P 2.1L can be configured by the  button. This is not recommended; reading out the pump transfers all necessary information to the software. In case of a hardware change (e.g. adding the LPG module to a former isocratic pump) it might be necessary.



**Note:** If a configuration change for pump P 2.1L is required, note that for the configuration of the ternary LPG block, 3 solvents must be configured. For the binary LPG block, 2 solvents must be configured in the software. Configuration of the wrong LPG module may damage the LPG valves. After opening the configured ClarityChrom® instrument, the information of the gradient mode will be sent to the pump.

The P 6.1L pump cannot be combined to an HPG system (neither with a second P 6.1L nor with other pumps), but has to be equipped as a binary gradient pump. Thus, only the gradient mode *HPG* instead of *HPG A - HPG D* can be selected. Additionally, the pump is equipped with 2 solvent selection valves (SSV). The pump then provides the HPG components A and B (or A1/A2 and B1/B2 in case of an SSV) internally.

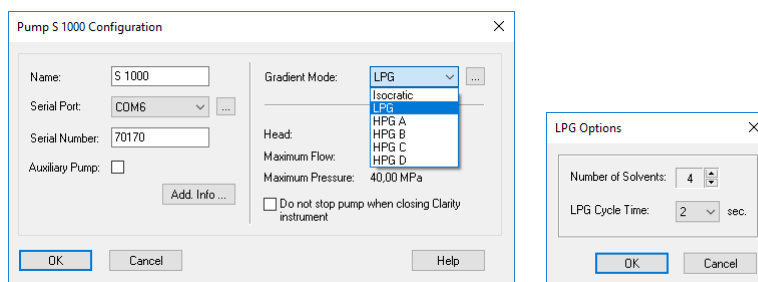
If more than one solvent pump is added in an instrument, they are recognized as HPG pumps automatically and can be programmed in the method only with a common table.



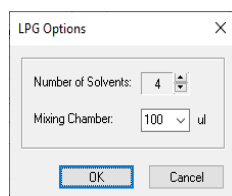
**Note:** HPG pump A has to be configured first and pump B afterwards. Otherwise, the configuration cannot be saved.

Only one LPG pump can be operated in one system.

Only after the LPG mode has been activated, a second menu can be accessed, in which the number of solvent components and the settings for the LPG cycle time (the time in which the LPG valves of the programmed channels are each accessed once) are set.



**Fig. 42:** Selection options for gradient modes



**Fig. 43:** LPG options P 6.1L



**Note:** To configure an HPG system correctly, you must add the HPG pumps to your instrument in the correct order.

Add HPG pump A first, then HPG pump B, etc. The pumps have to be added in this order in the selected system as well. If a gradient system has not been configured as described above, after clicking *OK* to store the configuration you are prompted to delete the configured pumps from the system and to reinstall in the correct order.

**Gradient Mode** When configuring an LPG system, the number of components and the LPG cycle time (LPG Cycle Time) can be determined. Click the button to open the respective dialogue.

*NUMBER OF SOLVENTS:* Select the number of appropriated solvent components from the drop-down list (only valid for LPG pumps). While deploying the method, the maximum number of components (channels) at your disposal, is the number configured. Do not select a number less than the maximum number of channels in configuration; in case of P 2.1L this may damage the LPG valves. You can reduce the number of components during the method.

*LPG CYCLE TIME:* Set desired LPG cycle time for the configured pump.

The appropriate LPG cycle time depends on the different parts of the components, the flow and the mixing chamber. The longer the appropriated time, the better the depiction of the very small parts of a component. But equally, the volume of the solvent „packages“ increases, which requires a larger mixing chamber volume. A larger mixing chamber volume also extends the time until a new gradient is introduced into the column. The goal is to achieve the best compromise possible for the separation task at hand.

*MIXING CHAMBER:* In case of a pump P 6.1L, instead of the LPG cycle time, the volume of the mixing chamber must be set correctly (50, 100, 200, or 350 µl). The pump uses this information to calculate the optimal LPG cycle time. If a wrong mixing chamber is selected, the calculation of the LPG cycles and, therefore, the gradient might be not correct.



**Note:** In ClarityChrom®, the isobar mode of the pump P 2.1L and the constant pressure mode of the pump P 6.1L are not supported. The P-max mode of the pump P 6.1L is supported.

Click on *OK* to close the dialogue and to return to the configuration window.



**Note:** For the pump P 2.1L you can set the gradient mode to Isocratic, LPG or HPG A, B, C or D. This information will be transferred to the pump after opening the instrument and established the communication. In case of an LPG pump, make sure the correct number of available solvent components (channels) is selected (either 2 or 3, depending of the LPG module), otherwise to LPG valves might be damaged.

**HEAD:** The correct pump head is selected after reading-out the pump, otherwise select the mounted pump head from the drop-down list.

PLATINblue P-1

S 100 / P2.1S/P4.1S

Preparative Pump 1800, P 2.1L

WellChrom K-1001/K-1000, K-501/K-120

AZURA® P 6.1L

**Fig. 44: Available pump heads**

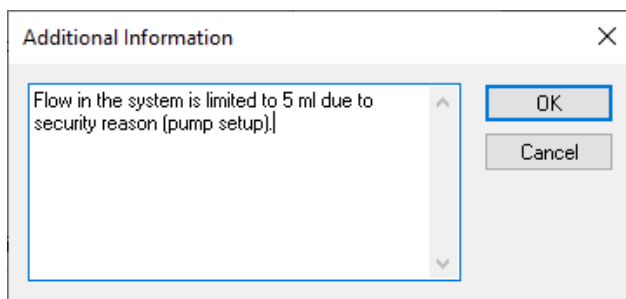
The selected pump head has to comply with the pump head which is mounted and configured in the pump. If the pump has been read out with the button, the pump head configured in the pump is set automatically. After you have chosen the pump head, the related information about material, the maximum flow and the maximum pressure is displayed automatically.

**AUXILIARY PUMP:** Activate this option to configure the pump as an auxiliary pump, e.g. for the injection of large sample volumes. Then the pump can be programmed separately in the method. Only pumps which are configured as isocratic or LPG, can be marked set as an **AUXILIARY PUMP**. All pumps which have not been configured as an **AUXILIARY PUMP** are automatically configured as **SOLVENT PUMPS**. If more than one solvent pump is added in an instrument, they are recognized as HPG pumps automatically and can be programmed in the method only with a common table.

**DO NOT STOP PUMP WHEN CLOSING CLARITY INSTRUMENT:** If this option is activated, the flow is not set to 0 if the software is exited. The pump(s) continue to run with the flow that has last been set in the software. If it is required to run the pump continuously, e.g. if a buffer is used, check this box. The pump display continues to indicate that the device is accessed by the software.

**LEAK SENSOR SENS. (P 6.1L and P 2.1L only):** Select the leak sensor sensitivity in accordance with your requirements. The choices are *OFF*, *LOW*, *MEDIUM* or *HIGH*.

**ADD. INFO:** After clicking on the *ADD. INFO...* button, you can enter additional information about the pump.



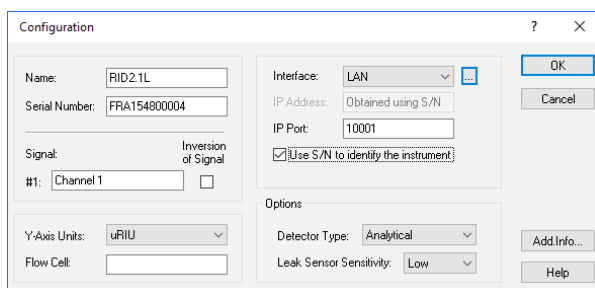
**Fig.45:** Additional information box

Enter additional information or comments to be printed out when you print the instrument configuration.

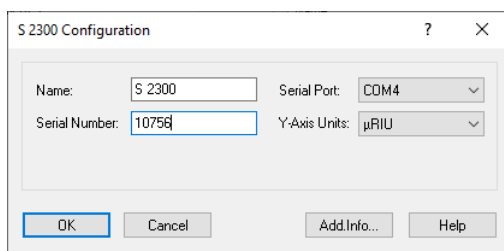
## 7.5 Configuration - KNAUER detectors

### 7.5.1 Configuration - KNAUER RI detectors

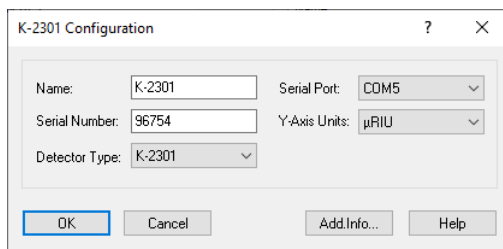
Several KNAUER RI detectors are supported. The configuration windows and procedures are nearly identical.



**Fig.46:** RID 2.1L Configuration window



**Fig.47:** S 2300 Configuration window



**Fig.48:** K-2301 Configuration window

*NAME*: The default detector name will be suggested automatically by selecting the detector type. Enter a descriptive name for the KNAUER interface device. This name will appear on the valves tab when the instrument setup or status windows is displayed.



**Note:** Use a name which is unique within the instrument (configuration). It is not allowed to configure two devices in an instrument with the same name.

*SERIAL NUMBER*: Type in the serial number of the detector you are using.

*[CHN.NAME] #1* (RID 2.1L only): You can enter a descriptive name for the channel.

*INVERSION OF SIGNAL [CHN. #1]* (RID 2.1L only): Check the *INVERSION OF SIGNAL* box to invert the data for the acquisition channel. This can be a helpful option to avoid negative peaks.

*SERIAL PORT*: From the drop-down list, select the serial port on your PC where your detector is connected.

*Y-AXIS UNITS*: Select the type of units to be displayed on the y-axis of your chromatogram from the drop-down list. For the RI detectors, the only choice is  $\mu$ RIU.

## Interface LAN

*IP ADDRESS* (RID 2.1L only): It will not be shown in the IP address field if the option *USE S/N TO IDENTIFY THE INSTRUMENT* is enabled. If you click on the button, the software recognizes the connected and switched-on device automatically. This procedure is recommended. If you plan to use the device with a static IP address, the device can still be recognized by its serial number. If you want to set a static IP address, deactivate the option *USE S/N TO IDENTIFY THE INSTRUMENT*. Afterwards, the IP address input field is active. Please note that the static IP address has to be set in the device itself as well. For detailed information, refer to the device's user manual.

*IP PORT*: The IP port number used for communication can be entered here. Please use only port 10001 for KNAUER devices.

*USE S/N TO IDENTIFY THE INSTRUMENT*: This option is activated by default.



**Note:** We highly recommend using the S/N and not the IP address to identify the instrument because devices may automatically receive a new IP address when reset. If a static IP address is used, the device can be recognized also by the serial number.

*DETECTOR TYPE* (WellChrom RI detectors only): Select the type of the detector you want to configure from the drop-down list. You can choose between: K-2300, K-2301, K-2400, and K-2401. Please note that the detectors K-2000 and K-2500 use the serial port only for data acquisition.

*LEAK SENSOR SENS.* (RID 2.1L only): Select the leak sensor sensitivity in accordance with your requirements. The choices are *OFF*, *LOW*, *MEDIUM* or *HIGH*.

*ADD. INFO.*: After clicking on the *ADD. INFO...* button, you can enter additional information about the detector.

When complete, click *OK* to close the window. The *OK* button for closing the configuration window is active only after a serial number has been entered.

## 7.5.2 Configuration - KNAUER UV detectors

The supported KNAUER UV detectors are:

- AZURA® MWD 2.1L, UVD 2.1L and UVD 2.1S
- WellChrom K-2000, K-2001, K-2500, K-2501
- Smartline 200, 2500, and 2520

The UV detectors with PDA or scanning functionality (K-2600, S 2550, and S 2600) are described separately. Please note that the detectors K-2000 and K-2500 only support the data acquisition via serial port. Wavelength control is not supported. The configuration windows and procedures of the other detectors are identically in each series.

**Fig. 49:** MWD 2.1L configuration window

**Fig. 50:** UVD 2.1L configuration window

**Fig. 51:** S 2520 configuration window

**Fig. 52:** UVD 2.1S configuration window

**Fig. 53:** S 2500 configuration window

**Fig. 54:** K-2501 configuration window

**NAME:** The default detector name will be suggested automatically by selecting the detector type. Enter a descriptive name for the KNAUER interface device. This name will appear on the valves tab when the instrument setup or status windows are displayed.



**Note:** Use a name which is unique within the instrument (configuration). It is not allowed to configure two devices in an instrument with the same name.

**SERIAL NUMBER:** Type in the serial number of the detector you are using.

**CHANNELS** (MWD 2.1L only): Select the number of the channels (1-8) to be used for data acquisition. Use the small arrow keys to select or deselect channels. The number of channels cannot be changed, if the detector was already added to an instrument. If you want to change the number of channels, first remove the device from the instrument. If changes are made, add the detector again to the mentioned instrument. At least one channel has to be selected. Channels 5 to 8 are only available via *MORE*.

**MORE...** (MWD 2.1L only): You can enter a name for channels 1 to 8.

**[CHN.NAME] #1...#4** (MWD 2.1L only): You can enter a descriptive name for every channel used.

*INVERSION OF SIGNAL [CHN. #1...#8]* (MWD 2.1L only): Check the *INVERSION OF SIGNAL* box to invert the data for the acquisition channel. This can be a helpful option if you use a strongly absorbing solvent and your target substance results in a negative peak.

*SERIAL PORT* (all detectors except MWD 2.1L, UVD 2.1L, UVD 2.1S, S 2520): From the drop-down list, select the serial port on your PC where your detector is connected.

#### Interface RS-232 (UVD 2.1S, S 2520 only)

*COM PORT*: From the drop-down list, select the serial port on your PC where your detector is connected. For the mentioned detectors the maximum data rate, using a serial communication port, is 10 Hz.



**Note:** For the detector S 2520, using the serial port limits the data acquisition rate of the detector to a maximum of 10 Hz.

To use the maximum data rate of 80 Hz, communication over LAN must be selected as the interface. For the detector S 2550, please refer to „Configuration - KNAUER UV detectors with PDA functionality“ on page 44.



**Note:** For the detector UVD 2.1S, using the serial port limits the data acquisition rate of the detector to a maximum of 10 Hz. To use the maximum data rate of 50 Hz, communication over LAN must be selected as the interface.

#### Interface LAN (Only MWD 2.1L, UVD 2.1L, UVD 2.1S, S 2520; necessary for data rates > 10 Hz)

*IP ADDRESS*: It will not be shown in the IP address field if the option *USE S/N TO IDENTIFY THE INSTRUMENT* is enabled. If you click on the  button, the software recognizes the connected and switched-on device automatically. This procedure is recommended. If you plan to use the device with a static IP address, the device can still be recognized by its serial number.

If you want to set a static IP address, deactivate the option *USE S/N TO IDENTIFY THE INSTRUMENT*. Afterwards, the IP address input field is active. Please note that the static IP address has to be set in the device itself as well. For detailed information, refer to the device's user manual.

*IP PORT*: The IP Port number used for communication can be entered here. Please use only port 10001 for KNAUER devices.

*USE S/N TO IDENTIFY THE INSTRUMENT*: This option is activated by default.



**Note:** We highly recommend using the S/N and not the IP address to identify the instrument because devices may automatically receive a new IP address when reset. If a static IP address is used, the device can be recognized also by the serial number.

*D2 LAMP / HALOGEN LAMP* (UVD 2.1L, S 2520 only): Select the build-in lamp. These detectors can only be equipped with one lamp.

*SHUTTER CONTROL*: This option is activated by default. If this option is chosen, the detector will open the shutter only before the run to protect the fiber optics. Additionally, the detector determines the optimal integration time for generating data points. Additionally the dark current will be measured and subtract it from all measured spectra. It is strongly recommended to leave this option enabled at all times.

*LEAK SENSOR SENS.* (MWD 2.1L, UVD 2.1L only): Select the leak sensor sensitivity in accordance with your requirements. The choices are *OFF*, *LOW*, *MEDIUM* or *HIGH*.



**Y-AXIS UNITS:** Select the type of units to be displayed on the y-axis of your chromatogram from the drop-down list. For the UV and diode array detectors the choices are AU (Absorption Units), mAU (0.001 AU) or  $\mu$ AU (0.000001 AU).

**FLOW CELL:** Enter a description for the flow cell you are using with your UV detector. The description will be printed out when you print the instrument configuration.

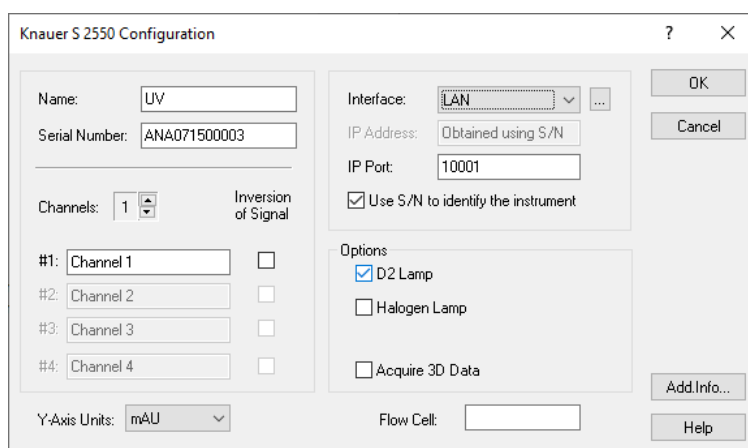
**DETECTOR TYPE (WellChrom series only):** Select the type of the detector you want to configure from the drop-down list. You can choose between K-2000, K-2001, K-2500, and K-2501. Please note that the detectors K-2000 and K-2500 use the serial port only for data acquisition.

**ADD. INFO:** After clicking on the **ADD. INFO...** button, you can enter additional information about the detector.

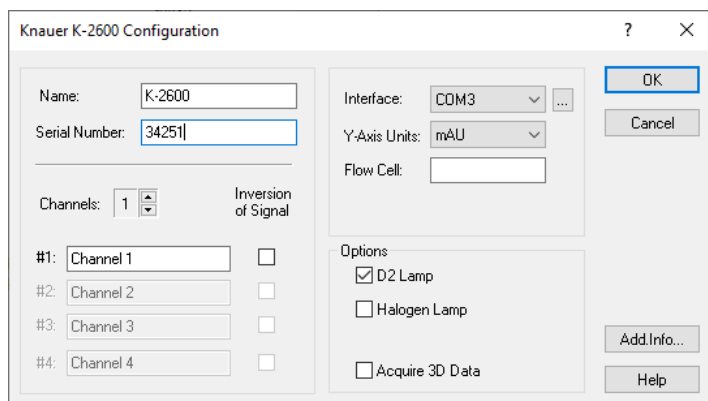
When complete, click **OK** to close the window. The **OK** button for closing the configuration window is active only after a serial number has been entered.

### 7.5.3 Configuration - KNAUER UV detectors with PDA functionality

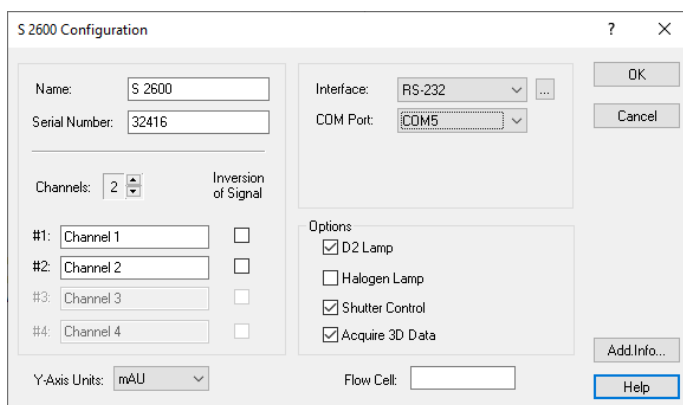
UV detectors with PDA functionality are K-2600, S 2550, and S 2600. For a system (instrument), up to two detectors with activated 3D functionality are permitted.



**Fig. 55:** S 2550 configuration window



**Fig. 56:** K-2600 configuration window




**Fig. 57:** S 2600 configuration window

**NAME:** The default detector name will be suggested automatically by selecting the detector type. Enter a descriptive name for the KNAUER interface device. This name will appear on the valves tab when the instrument setup or status windows are displayed.



**Note:** Use a name which is unique within the instrument (configuration). It is not allowed to configure two devices in an instrument with the same name.

**SERIAL NUMBER:** If the connected and switched-on device is read out with the  button, the serial number is read out and filled in automatically. Otherwise type in the serial number of the pump you are using. If the serial number is not entered correctly, communication problems with the detector are likely to occur.

**CHANNELS:** Select the number of the channels (1-4) to be used for data acquisition. If you want to acquire data from the detector S 2550 with a data rate of 10 Hz or higher (max. 80 Hz), only select one channel. In this case, it has to be connected via LAN.

The number of channels cannot be changed if the detector has already been added to an instrument. If you want to change the number of channels, first remove the device from the instrument. If changes are made, add the detector again to the mentioned instrument.

**[CHN.NAME] #1...#4:** You can enter a descriptive name for every channel used.

**INVERSION OF SIGNAL [CHN. #1...#4]:** Check the **INVERSION OF SIGNAL** box to invert the data for the acquisition channel. This can be a helpful option if you use a strongly absorbing solvent and your target substance results in a negative peak.

**Y-AXIS UNITS:** Select the type of units to be displayed on the y-axis of your chromatogram from the drop-down list. For diode array detectors, only mAU (0.001 AU) is possible.

### Interface RS-232 (only S 2550, S 2600)

**COM PORT:** From the drop-down list, select the serial port on your PC where your detector is connected. For the S 2550, the maximum data rate for one channel, using serial communication, is 10 Hz.



**Note:** When using the serial port and activating more than one channel, the data acquisition rate of the S 2550 detector is limited to a maximum of 10 Hz. Higher data rates of up to 80 Hz are only possible when using a LAN connection and one activated channel.



**Note:** In order to be accessed with ClarityChrom®, the detector S 2600 must be set to *RS232 BINARY BAUD RATE 115200* in its own setup menu under *CONTROL*. Please note that the serial cable must not be longer than 2 m.

## Interface LAN (S 2550 only, required for data rates higher 10 Hz)

**IP ADDRESS:** If the option *USE S/N TO IDENTIFY THE INSTRUMENT* is activated, this input field is grayed out. If you click on the  button, the software recognizes the connected and switched-on device automatically. This procedure is recommended. If you plan to use the device with a static IP address, the device can still be recognized by its serial number. If you want to set a static IP address, deactivate the option *USE S/N TO IDENTIFY THE INSTRUMENT*. Afterwards, the IP Address input field is active. Please note that the static IP address has to be set in the device itself as well. For detailed information, refer to the device's user manual.

**IP PORT:** The IP port number used for communication can be entered here. Please use only port 10001 for KNAUER devices.

**USE S/N TO IDENTIFY THE INSTRUMENT:** This option is activated by default.



**Note:** We recommend the use of the option *USE S/N TO IDENTIFY THE INSTRUMENT* to obtain the IP address automatically, especially if a DHCP server (e.g. a router) is used. We highly recommend using the S/N and not the IP address to identify the instrument because devices may automatically receive a new IP address when reset. If a static IP address is used, the device can be recognized also by the serial number.

**INTERFACE (only K-2600):** From the drop-down list, select the serial port on your PC where your detector is connected. The *OK* button for closing the configuration window is active only after a serial number has been entered.

**INTERFACE: [...]:** Click the  button to get a list of all devices of the selected type, connected to the selected interface. Select a device and click on *SELECT #* to confirm. The corresponding configuration information, e.g. the serial number, are read out by the device. For the detector S 2600 a window with information is displayed which are necessary for a correct data transmission. Click *ACCEPT* to transfer this information. If the configuration data has been read out as described above, it does not have to be entered manually.

**D2 LAMP:** Check this box if the detector is equipped with a D2 lamp.

**HALOGEN LAMP:** Check this box if the detector is equipped with a halogen lamp. Only the detector S 2550 can be equipped with both lamps. In this case, the serial number does not have to be entered manually.

**FLOW CELL:** Here you can enter a description for the flow cell you are using with your UV detector. The description will be printed out when you print the device configuration.

**SHUTTER CONTROL (only S 2600):** This option is activated by default. If this option is chosen, the detector will open the shutter only before the run to protect the fiber optics. Additionally, the detector determines the optimal integration time for generating data points. Additionally the dark current will be measured and subtract it from all measured spectra. It is strongly recommended to leave this option enabled at all times.

**ACQUIRE 3D DATA:** Check the *ACQUIRE 3D DATA* option to utilize the full spectral functionality of these detectors. If the *ACQUIRE 3D DATA* option is selected, you will need additional PDA license option to be able to work with the spectral data. If this option is not selected, the detector will be used as a multi-channel detector. Please note that the detectors S 2550 and K-2600 cannot perform a permanent scan. The scan must be programmed time-based.

*ADD. INFO:* After clicking on the *ADD. INFO...* button, you can enter additional information about the detector.



**Note:** If a PDA detector is used, for the appropriate instrument the PDA option must be enabled in the instrument type settings. Only then the detector can be added to the instrument.

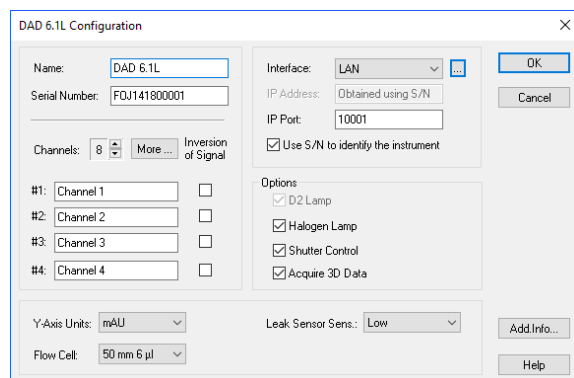
When complete, click *OK* to close the window.

## 7.5.4 Configuration - KNAUER PDA detectors

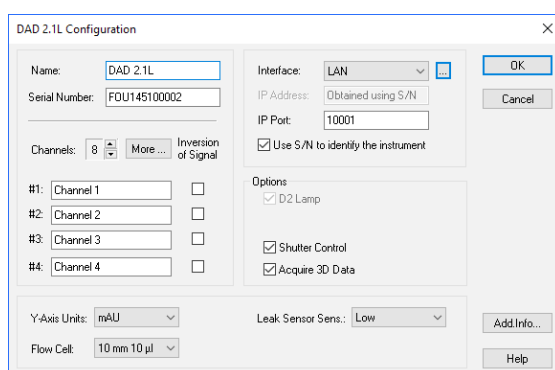
Supported KNAUER detectors are:

- PDA detectors AZURA® DAD 6.1L and AZURA® DAD 2.1L,
- PLATINblue PDA-1
- Smartline 2850 and 2800
- WellChrom K-2800 and K-2700

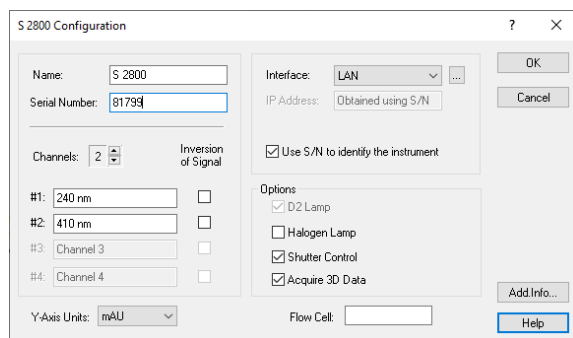
For a system (instrument), up to two detectors with activated 3D functionality are permitted. Please note that the PCI interface card for the detectors K-2800 and K-2700 only runs under a 32 bit version of Windows up to Windows 7.



**Fig. 58:** DAD 6.1L configuration window



**Fig. 59:** DAD 2.1L configuration window



**Fig. 60:** S 2800 configuration window

**NAME:** The default detector name will be suggested automatically by selecting the detector type. Enter a descriptive name for the KNAUER interface device. This name will appear on the valves tab when the instrument setup or status windows are displayed.



**Note:** Use a name which is unique within the instrument (configuration). It is not allowed to configure two devices in an instrument with the same name, e.g. 2x "UV" for two UV detectors.

**SERIAL NUMBER:** Type in the serial number of the detector you are using.

**CHANNELS:** Select the number of the channels to be used for data acquisition. Use the small arrow keys to select or deselect channels. At least one channel has to be selected. The PDA-1 supports up to 6 channels and the DAD 6.1L and DAD 2.1L support up to 8 channels. Channels 5 and 8 are only available via *MORE*.

The number of channels cannot be changed, if the detector was already added to an instrument. If you want to change the number of channels, first remove the device from the instrument. If changes are made, add the detector again to the mentioned instrument.


**MORE...** (PDA-1, DAD 6.1L, DAD 2.1L only): You can enter a name for channels 1 to 8.

**[CHN.NAME] #1...#8]:** You can enter a descriptive name for every channel used.

**INVERSION OF SIGNAL [CHN. #1...#8]:** Check the *INVERSION OF SIGNAL* box to invert the data for the acquisition channel. This can be a helpful option if you use a strongly absorbing solvent and your target substance results in a negative peak.

**INTERFACE:** PDA detectors can be accessed via Ethernet (LAN). The detectors K-2800 and K-2700 need a special box which converts the serial output of the detector to Ethernet. By default, both detectors (K-2800 and K-2700) are accessed via a card which has to be installed into a free PCI slot of the computer. If the PCI interface card is used and installed correctly, it is found automatically. No additional input is necessary. Please note that the PCI interface card for the detectors K-2800 and K-2700 only runs under a 32 bit version of Windows up to Windows 7.

### Interface LAN

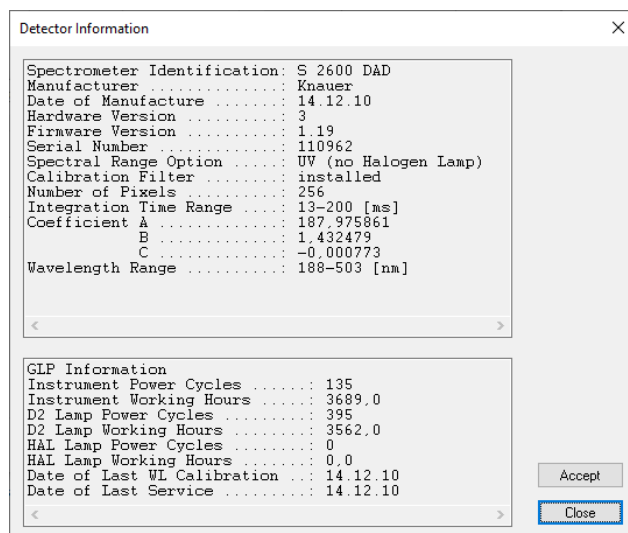
**IP ADDRESS:** If the option *USE S/N TO IDENTIFY THE INSTRUMENT* is activated, this input field is grayed out. If you click on the  button, the software recognizes the connected and switched-on device automatically. This procedure is recommended. If you plan to use the device with a static IP address, the device can still be recognized by its serial number. If you want to set a static IP address, deactivate the option *USE S/N TO IDENTIFY THE INSTRUMENT*. Afterwards, the IP Address input field is active. Please note that the static IP address has to be set in the device itself as well. For detailed information, refer to the device's user manual.

*USE S/N TO IDENTIFY THE INSTRUMENT*: This option is activated by default.



**Note:** We recommend the use of the option *USE S/N TO IDENTIFY THE INSTRUMENT* to obtain the IP address automatically, especially if a DHCP server (e.g. a router) is used. We highly recommend using the S/N and not the IP address to identify the instrument because devices may automatically receive a new IP address when reset. If a static IP address is used, the device can be recognized also by the serial number.

*INTERFACE: [...]*: Click the  button to read out the corresponding configuration information directly from the device. Press the *ACCEPT* button to use the read configuration settings in the detector configuration window.



**Fig. 61:** Spectrometer information window



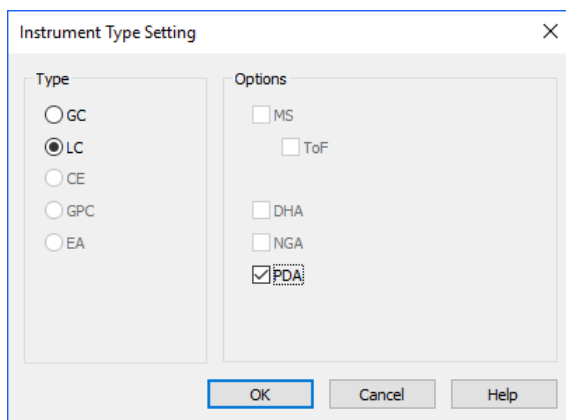
**Note:** The PDA detectors S 2850, S 2800 and K-2800 must download their firmware from the computer after every restart. This happens either by clicking the  button or if the instrument is started/opened. During the firmware download and the initialization, the LED flashes. This is normal behaviour and does not indicate a device error. The firmware download also switch on the detector lamp(s). If only the device will be switched on, the lamp(s) will not start.

*D2 LAMP*: Check this box if the detector is equipped with a D2 lamp.

*HALOGEN LAMP*: Check this box if the detector is equipped with a halogen lamp.

*SHUTTER CONTROL*: This option is activated by default. If this option is chosen, the detector will open the shutter only before the run to protect the fiber optics. Additionally, the detector determines the optimal integration time for generating data points. Also the dark current will be measured and subtract it from all measured spectra. It is strongly recommended to leave this option enabled.

*ACQUIRE 3D DATA*: Check the *ACQUIRE 3D DATA* option to utilize the full spectral functionality of this detector. If the *ACQUIRE 3D DATA* option is selected, you will need additional PDA license option to be able to work with the spectral data. If this option is not selected, the detector will be used as a multi-channel detector. For each system (instrument) only one detector with activated 3D functionality is permitted. If the *ACQUIRE 3D DATA* functionality is activated, *SYSTEM CONFIGURATION · INSTRUMENT TYP · LC-PDA* has to be selected in the window (see Fig. 62 on page 50).



**Fig. 62:** PDA detector, device type



**Note:** If a PDA detector is used, for the appropriate instrument the PDA option must be enabled in the instrument type settings. Then the detector can be added to the instrument.

**Y-AXIS UNITS:** Select the type of units to be displayed on the y-axis of your chromatogram from the drop-down list. The choices are AU (Absorption Units), mAU (0.001 AU) or  $\mu$ AU (0.000001 AU).

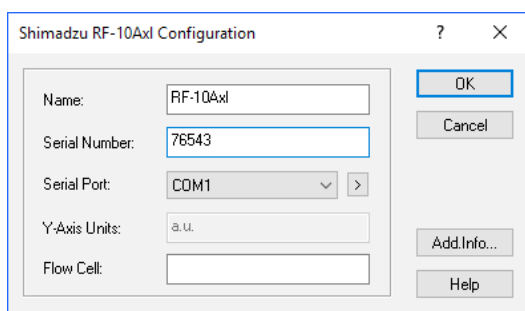
**FLOW CELL:** Enter a description for the flow cell you are using with your UV detector. The description will be printed out when you print the instrument configuration. The options for the DAD 6.1L and DAD 2.1L are 3 mm 2  $\mu$ l, 10 mm 2  $\mu$ l, 10 mm 10  $\mu$ l, 50 mm 6  $\mu$ l, test cell and fiber optics.

**LEAK SENSOR SENS. (AZURA® DAD 6.1L, DAD 2.1L only):** The sensitivity of the leak sensor depends on the selected setting. Three different settings are available: *OFF* (leak sensor is switched off), *LOW* (low sensitivity), *MEDIUM* (medium sensitivity), and *HIGH* (high sensitivity).

**ADD. INFO:** After clicking on the *ADD. INFO...* button, you can enter additional information about the detector.

When complete, click *OK* to close the window. The *OK* button for closing the configuration window is active only after a serial number has been entered.

## 7.5.5 Configuration - Spectrofluorometric Detector RF-10Axl, RF-20A/Axs



**Fig. 63:** RF-10Axl configuration window



**Note:** The KNAUER drivers for the Shimadzu fluorescence detector RF-20A/Axs allows access and data acquisition via the RS-232 interface. As of June 2014, the firmware version 0.90 is required. Other firmware versions do not work. The RF-20A/Axs is limited to the functionality for the RF-10Axl driver beside the maximum data rate (RF-20A/Axs: 5 Hz, RF-10Axl: 0.5 Hz. Further functionality is not supported. Especially the options for data acquisition on two independent channels (so called 4 channel wavelength mode) or tempering the measurement cell are not supported. Wavelength scans cannot be programmed, executed or stored in a method.



**Note:** The Shimadzu fluorescence detector RF-10Axl only allows a data acquisition rate of 0.5 Hz via RS-232. For a higher data rate, the data acquisition via analog output and an A/D converter box (e.g. a KNAUER IFU 2.1) is recommended.



**Note:** Both detectors may not work on additionally installed serial (COM) ports. It is recommended to connect it with a computer's onboard COM port.

*NAME:* The default detector name will be suggested automatically by selecting the detector type. Enter a descriptive name for the KNAUER interface device. This name will appear on the valves tab when the instrument setup or status windows are displayed.

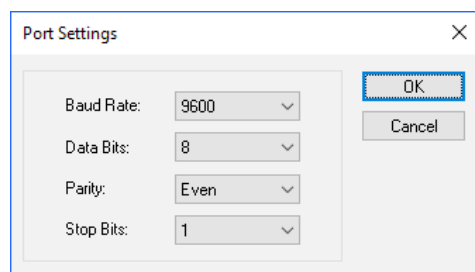


**Note:** Use a name which is unique within the instrument (configuration). It is not allowed to configure two devices in an instrument with the same name.

*SERIAL NUMBER:* Type in the serial number of the detector you are using.

*SERIAL PORT:* From the drop-down list, select the serial port on your PC where your detector is connected. The *OK* button for closing the configuration window is active only after a serial number has been entered.

*SERIAL PORT, >:* Click on > to configure the communication port.



**Fig. 64:** Serial port settings

Select the settings from the drop-down list as shown in the figure above.



**Note:** The port settings must coincide with the RS-232 parameters on the detector.

*FLOW CELL:* Enter a description for the flow cell you are using with your spectrofluorometric detector. The description will be printed out when you print the instrument configuration.

*ADD. INFO:* After clicking on the *ADD. INFO...* button, you can enter additional information about the detector.

When complete, click *OK* to close the window. The *OK* button for closing the configuration window is active only after a serial number has been entered.





**Note:** The detectors RF-10Axl and RF-20A/Axs must be switched into serial mode. Please refer the detector's manual (RF-10Axl -> pages 7-18 through 7-25) for detailed information. The detector RF-20A/Axs is set to serial mode, if KNAUER has updated the firmware to version 0.90.

### How to switch the spectrofluorometric detector into serial mode

**RF-10Axl** Repeatedly press the *FUNCTION* button on the detector until *RS232C* is displayed. Confirm with the *E* button. The display will show *CONNECT*, also confirm with *E* key. Now the device operates in serial mode and can be driven by the software. If the detector is switched off and on, it will start again in RS-232 control mode. The keypad is blocked.

To leave the serial mode, press the *SHIFT* and *CE/DEL* key at the same time. Now the keypad is accessible, but the device cannot be controlled by software.

If you press *FUNCTION* while *CONNECT* is displayed, the parameters for the serial interface integrated into the device are displayed. The COM settings here and in the software must be identical. Changes have to be confirmed by pressing *E*. To move to the next parameter, press the *FUNCTION* key on the detector.

Parameter	Value
Baud	6 (means 9600)
Data Bits	8
Parity	2 (means even parity)
Stop Bit	1

The COM settings here and in the software must be identical. If, e.g., the parity is set to 2 (even parity), the same value must be set in the detector and in the software.

If all parameters have been checked, the display shows the message *CLOSE KEY*. Press key *E* to leave the setup. To switch the device to serial control mode, please follow the steps above.

**RF-20A/Axs** Press *FUNCTION* on the detector repeatedly until the display shows *SYSTEM\_ENTER TO SELECT*. Press the *ENTER* key. Now the settings for the serial interface can be reviewed and modified if necessary. To move to the next parameter, press the *FUNCTION* key.

Parameter	Value
Baud	9600
Data Bits	8
Parity	2 (means even parity)
Stop Bit	1

The COM settings here and in the software must be identical. If, e.g., the parity is set to 2 (even parity), the same value must be set in the detector and in the software.

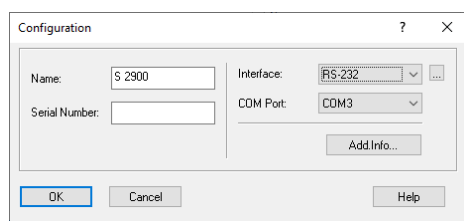
If all parameters have been checked, the display shows *RS-232C \_ ENTER TO ENABLE*. Press the *ENTER* key. The display shows *RS-232C \_ ENABLE* for about 2 seconds, then the default screen will be shown. Now the detector is in serial control mode and can be controlled by software. If the detector is switched off and on, it will start again in RS-232 control mode. During the boot process, *RS-232 CONTROL MODE* will be shown very shortly on the display. The keypad is blocked.

To leave the serial mode, simultaneously press *CE* and *DEL*. Now the keypad is accessible, but the device cannot be controlled by software.

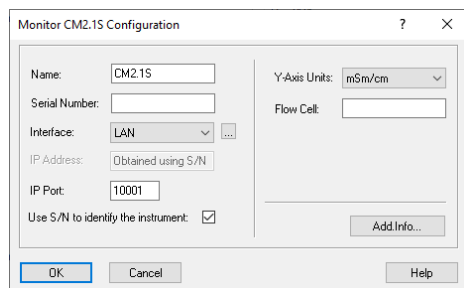


**Note:** The driver for the model RF-20A/Axs only supports the firmware version 0.90. This firmware is only available through KNAUER. The control is compatible with model RF-10Axl and will not support the advanced features of the model RF20A/Axs.

## 7.5.6 Configuration - Conductivity Monitor Smartline 2900, AZURA® CM 2.1S



**Fig. 65:** Conductivity monitor Smartline 2900



**Fig. 66:** Conductivity monitor AZURA® CM 2.1S

**Configuration** *NAME:* The default detector name will be suggested automatically by selecting the detector type. Enter a descriptive name for the KNAUER interface device. This name will appear on the valves tab when the instrument setup or status windows are displayed.




**Note:** Use a name which is unique within the instrument (configuration). It is not allowed to configure two devices in an instrument with the same name.

*SERIAL NUMBER:* Type in the serial number of the conductivity monitor you are using.

**Interface RS-232** *COM PORT:* From the drop-down list, select the serial port on your PC where your detector is connected. The serial number of the S 2900 cannot be read-out from the device.

**Interface LAN** (CM 2.1S only)

*IP ADDRESS:* It will not be shown in the IP address field if the option *USE S/N TO IDENTIFY THE INSTRUMENT* is enabled. If you click on the  button, the software recognizes the connected and switched-on device automatically. This procedure is recommended. If you plan to use the device with a static IP address, the device can still be recognized by its serial number.

*IP PORT:* The IP Port number used for communication can be entered here. Please use only port 10001 for KNAUER devices.

*USE S/N TO IDENTIFY THE INSTRUMENT:* This option is activated by default.



**Note:** We highly recommend using the S/N and not the IP address to identify the instrument because devices may automatically receive a new IP address when reset.

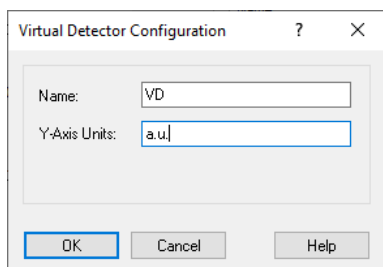
**Configuration** *Y-AXIS UNITS* (CM 2.1S only): The only available unit is mSm/cm. The values for temperature and pH are provided as *AUXILIARY TRACE*, the corresponding units are set automatically.

*FLOW CELL* (CM 2.1S only): Here you can enter a description for the flow cell you are using with your conductivity monitor. The description will be printed out when you print the device configuration.

*ADD. INFO:* After clicking on the *ADD. INFO...* button, you can enter additional information about the detector.

When complete, click *OK* to close the window. The *OK* button for closing the configuration window is active only after a serial number has been entered.

## 7.5.7 Configuration - virtual detector



**Fig. 67:** Virtual detector configuration window

A virtual detector is a „device“ which can acquire data from different sources. This way, it is possible to recreate an existing chromatogram, e.g. to adjust the fractioning. It is also possible to display the traces of 2 detectors in one chromatogram, e.g. to add them up. Because it is not a physical device, no interface can be selected for the virtual detector. During method setup, you select the source from which the data should be acquired. The virtual detector can be used for triggering (starting a method via an outside signal) as well. This feature may be needed if the used devices do not support this or if there is no triggering „event“, e.g. a sample purification.

*NAME:* Enter optionally another descriptive name for the detector. Use a name which is unique within the instrument. This name will appear on the valves tab when the instrument setup or status windows are displayed. VD (for virtual detector) is preset.



**Note:** Use a name which is unique within the instrument (configuration). It is not allowed to configure two devices in an instrument with the same name.

*Y-AXIS UNITS:* Enter the units of your signal to be displayed on the y-axis, e.g.  $\mu\text{V}$ , AU, MPa, etc.

## 7.6 Configuration - KNAUER interfaces

KNAUER offers an A/D converter, which can control devices or acquire data from devices which are not supported by the software. While the necessary hardware is integrated in the managers 5000 and 5050 in a multi-purpose device, which in addition can receive a degasser and/or an LPG block, the interface boxes IFU 2.1, IFU 2.1 LAN, IF2 and KNAUER HPLC box are designed as AD converters only.

The Manager 5000/5050, the IF2, IFU 2.1, IFU 2.1LAN or the KNAUER HPLC box have to be configured to integrate devices into the system, which are defined by the user and are not supported by ClarityChrom®. The interfaces can be found in the section LC as all pumps. Note that the analog and digital outputs of the KNAUER HPLC box are only supported for the hardware revision 3 (KNAUER serial number > 50,000).

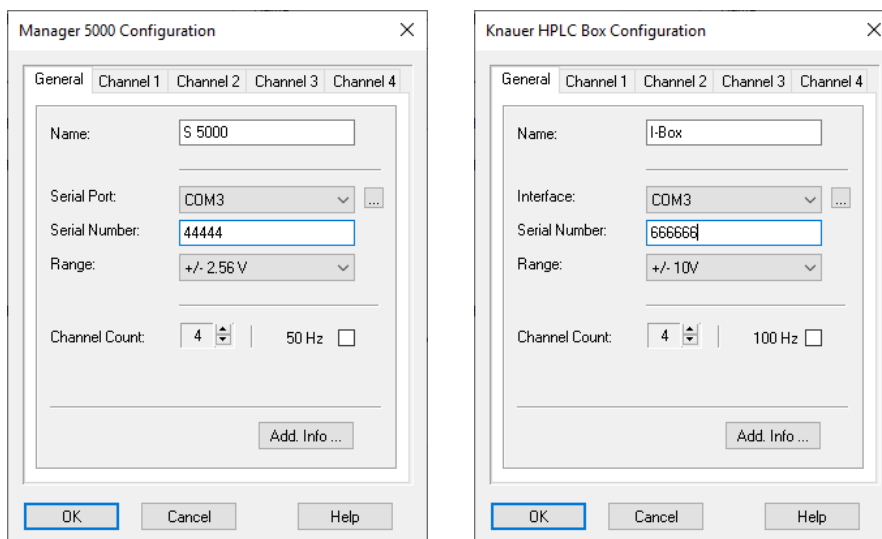
For the older version 2, only the data acquisition via analog input is supported. The digital outputs of all interface devices are not supported and cannot be programmed. The digital output will be used as the autozero output automatically if the analog input of the same channel is used for data acquisition. In the case of the KNAUER HPLC box, it is D. OUT 3.

Please refer to the manual of the A/D converter for permitted voltages. Applying excess voltage may destroy the device.

The configuration of the Manager 5000, Manager 5050, IF2, IFU 2.1 and IFU 2.1LAN is identical, the KNAUER HPLC box deviates from this procedure only at a few points. If the configuration data of the KNAUER HPLC box is being read out during the configuration, as recommended, ClarityChrom® automatically recognizes the operation mode of the box and changes the box settings if necessary.



**Note:** The Manager 5000 or 5050 can only be added, if it includes the A/D converter card. For using the LPG valves or the degassing unit the manager must not be configured.



**Fig. 68:** Configuration window Smartline Manager 5000 and IF2 KNAUER HPLC box



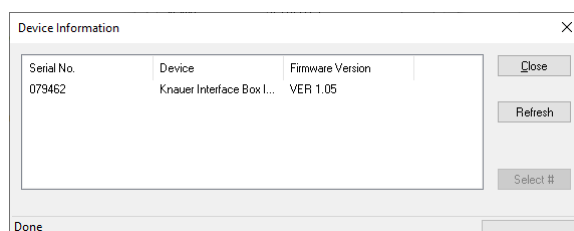
**Note:** The Manager 5050 must be configured as Manager 5000.

*NAME:* The default detector name will be suggested automatically by selecting the detector type. Enter a descriptive name for the KNAUER interface device. This name will appear on the valves tab when the instrument setup or status windows are displayed.



**Note:** Use a name which is unique within the instrument (configuration). It is not allowed to configure two devices in an instrument with the same name.

*SERIAL PORT / INTERFACE:* From the drop-down list, select the serial port on your PC where your KNAUER interface is connected. For the IFU 2.1 LAN select LAN as the interface. Click the [...] button to get a list of all devices of the selected type, connected to the selected interface. Select a device and click on *SELECT #* to confirm. The corresponding configuration information, e.g. the serial number, are read out by the device. This procedure is recommended.



**Fig. 69:** Device information window IF2/IFU 2.1

*SERIAL NUMBER:* If you have read out the device via the [...] button, as described above, the serial number has been added automatically. You can also enter the serial number manually. As the serial number on the device does not have to match the serial number which is stored in the device and has to be used for configuration, note the following:




**Note:** The Manager 5000/5050 / IF2 / IFU 2.1 interface can only store a five-digit serial number. If the serial number is higher than 99999, only the last five digits will be shown. Accordingly, the last 5 digits of the serial number may be entered during the configuration (example: 134355 → 34355 resp. ADA120112204 →

12204). If the second digit of the serial number is a zero, the zero will not be saved and the serial number will therefore only have four digits (example: 104567 → 4567 resp. ADA120102204 → 2204).



**Note:** The KNAUER HPLC box cannot store a serial number higher than 65536. If the serial number is higher, only the last four digits will be saved (72345 → 2345). This number has to be entered during the configuration.



**Note:** To avoid communication problems of interface boxes and interface modules, KNAUER recommends that the serial number be read out using the  button. In order to do so, the device has to be connected and switched-on and the right COM port has to be selected in the configuration.

**RANGE:** In the drop-down list, select the voltage range for the analog input of your detector. The following ranges are available:  $\pm 2.56$  V,  $\pm 1.28$  V,  $\pm 0.64$  V,  $\pm 0.32$  V, and  $\pm 0.16$  V. For the KNAUER HPLC box  $\pm 10$  V,  $\pm 1$  V,  $\pm 0.1$  V, and  $\pm 0.01$  V can be set. Note the measuring range of the device you want to connect. With many detectors, the analog output is set to  $\pm 1$  V. If the selected input value for the A/D converter is too low, higher measuring values are not recorded. Since the A/D converter has a resolution of 24 bit, the smallest possible step between two measuring values is  $0.3 \mu\text{V}$ , corresponding to  $\pm 2.56$  V.

**CHANNEL COUNT:** Select the number of channels in use.

**50 HZ / 100 HZ OPTION:** This option switches the KNAUER interface device from the default setting 10 Hz to a data rate of 50 Hz for the manager 5000/5050, the IF2/IFU 2.1, or 100 Hz for the KNAUER HPLC box.



**Note:** Note that enabling the high sampling rate mode will allow only working with channel 1, all other channels will be disabled then. Additionally the analog output control feature will be disabled for this channel.

**ADD. INFO:** After clicking on the **ADD. INFO...** button, you can enter additional information about the detector.

**CHANNEL # (1-4):** Subsequently, select the **CHANNEL** tab each separate configuration. The number of channel tabs corresponds to the setting in **CHANNEL COUNT**. Each channel can be configured independent from the others.

Later on, it is possible to allocate the channels to different systems (instruments). The channel number in the software corresponds to the channel number on the A/D converter.

### Channel window

**NAME:** Each channel can be named separately. These are the names that the program later uses for the channel names in the chromatograms. However, each name may be used only once per system.

**ACQUISITION:** If this option is activated, the analog input will be used for data acquisition. Simultaneously, the digital output of this channel is used as autozero output automatically. There is a one-second short circuit impulse when the chromatogram is initialized or a method is sent. The recorded chromatogram is treated in the software like the chromatogram of any other detector. It can be evaluated, used for calibrating and the results can be displayed as a report.

**AUXILIARY:** If this option is activated, the signal is recorded via analog input of the device but will not be treated like a chromatogram in the software. It cannot be evaluated and not be used for calibrating. Its results cannot be displayed. This option is meant for recording data from peripheral devices, e.g. thermometers, pressure sensor, pH measuring devices. To activate the check box **AUXILIARY**, the check box **ACQUISITION** has to be activated.

*Y-AXIS UNITS*: Here you can enter the measuring signal unit appropriate for your detector. The default unit is mV (millivolt) since the A/D converter measures voltage. If you select another unit, make sure that you enter the right conversion factor for the measuring signal to be recorded via *Y-AXIS MULTIPLIER*.

*Y-AXIS MULTIPLIER*: Here you can enter the conversion factor for the measuring signal for the actual recorded voltage. The default value is 0.001 because the software displays the recorded value in micro volt but the unit is millivolt.

*Y-AXIS OFFSET*: If the recorded signal is not 0 (zero) when the detector itself displays 0, you can correct this value via *Y-AXIS OFFSET*. Please note that the offset is multiplied with *Y-AXIS MULTIPLIER* as well. If in the default setting (*Y-AXIS UNITS*: mV and *Y-AXIS MULTIPLIER*: 0.001) a signal of -2mV is displayed and the detector itself displays a signal of 0, the signal can be offset from 2000 to 0 with *Y-AXIS OFFSET*. If the signal is 3 mV, an *Y-AXIS OFFSET* of -3000 has to be entered.

*ANALOG OUTPUT*: The analog output of an A/D converter can be used to drive those devices which are designed for it. The flow of some pumps can be controlled via the analog input, and on some detectors, the wavelength can be set via the analog input. The analog output of the manager 5000/5050 or the IF2/IFU 2.1 has a range of 0-10 Volt. The smallest possible voltage step for a 12 bit resolution is at 2.44 mv Please refer to the manual of the A/D converter for current values. To activate the analog output, click the *ANALOG OUTPUT* check box.

*MODE*: Three modes can be selected from the drop-down list: *GENERIC DEVICE*, *LC PUMP* or *DETECTOR*. If *LC PUMP* or *DETECTOR* is selected, the button *OPTIONS* is activated. This opens a menu, in which the voltages can be configured, which are later set in the method setup to drive respective devices via the analog output. In the *GENERIC DEVICE* mode, the voltage is displayed as it is programmed in the setup.

*LC PUMP*: If you want to control a pump with the analog output of the A/D converter, select the mode *LC PUMP*. In this mode, during method setup the flow instead of the voltage is retrieved when programming the analog output of the A/D converter. Click *OPTIONS* to open the options menu.

*FACTOR*: The factor enables you to program a flow rate instead of a voltage during method setup and makes the software calculate the necessary voltage autonomously. Please refer to the manual of the A/D converter for necessary information.

*MAXIMUM FLOW*: Enter the maximum flow rate that is supported by your pump. This mode prevents programming a flow rate higher than the supported flow rate during method setup.

*DETECTOR*: If you want to control the wavelength of a detector via analog control, select *DETECTOR* from the drop-down list. During method setup the wavelength instead of the voltage is retrieved when programming the analog output of the A/D converter. Click *OPTIONS* to open the options menu.

*MINIMUM WL / MAXIMUM WL*: Enter the wavelength range that is supported by your detector. This mode prevents programming a wavelength higher or lower than the supported wavelength during method setup.

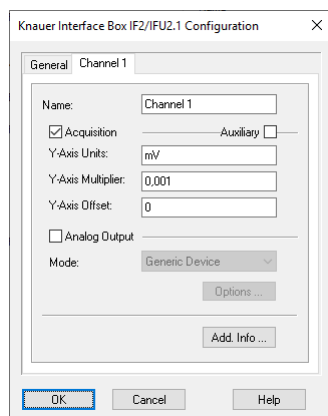
When complete, click *OK* to close the window.

If you want to use multiple channels of the A/D converter, you have to perform the configuration for each channel. Please note that analog input and the analog output cannot be used simultaneously.

When complete, click *OK* to close the window. The *OK* button for closing the configuration window is active only after a serial number has been entered.

## 7.6.1 Configuration - KNAUER interface channels

The following settings must be entered separately for each of the KNAUER interface device channels. Both Smartline Manager 5000 / IF2 and KNAUER HPLC box use the same channel configuration procedure. Every KNAUER interface device can be configured to use up to 4 channels. Note that each of these channels can be assigned to different ClarityChrom® instruments.



**Fig. 70:** Configuration window interface channels

**NAME:** Each channel can be named separately. These are the names that the program later uses for the channel names in the chromatograms. However, each name may be used only once per system.



**Note:** Use a name which is unique within ClarityChrom®. It is not allowed to configure two devices with the same name.

**ACQUISITION:** If this option is activated, the analog input will be used for data acquisition. Simultaneously, the digital output of this channel is used as autozero output automatically. There is a one-second short circuit impulse when the chromatogram is initialized or a method is sent. The recorded chromatogram is treated in the software like the chromatogram of any other detector. It can be evaluated, used for calibrating and the results can be displayed as a report.

**AUXILIARY:** If this option is activated, the signal is recorded via the analog input of the device and saved as trace in the software but will not be treated like a chromatogram in the software. It cannot be evaluated and not be used for calibrating. Its results cannot be displayed. This option is meant for recording data from peripheral devices, e.g. thermometers, pressure sensor, pH measuring devices. To activate the check box *AUXILIARY*, the check box *ACQUISITION* has to be activated.

**Y-AXIS UNITS:** Here you can enter the measuring signal unit appropriate for your detector. The default unit is mV (millivolt) since the A/D converter measures voltage. If you select another unit, make sure that you enter the right conversion factor for the measuring signal to be recorded via *Y-AXIS MULTIPLIER*.

**Y-AXIS MULTIPLIER:** Here you can enter the conversion factor for the measuring signal for the actual recorded voltage. The default value is 0.001 because the software displays the recorded value in micro volt but the unit is millivolt. The following table shows examples for the names of the y-axis (units) and the necessary conversion factors.



Y-Axis Label	Y-Axis Multiplier
Volt	0.000001
Millivolt	0,001
Microvolt	1
Other	Enter a number such that when multiplied by microvolts, gives the desired units.

For example, if you want the label to be units and each unit corresponds to 5 microvolts of signal, enter 0.2 ( $1/5 = 0.2$ ).

*Y-AXIS OFFSET*: If the recorded signal is not 0 (zero) when the detector itself displays 0, you can correct this value via *Y-AXIS OFFSET*. The offset has to be entered with the same unit that is used for the y-axis. Please note that the offset is multiplied with *Y-AXIS MULTIPLIER* as well.

$$DU = MS * Y-M + Y-O$$

DU = displayed units  
 MS = measured signal in micro volts  
 Y-M = Y-Axis Multiplier  
 Y-O = Y-Axis Offset

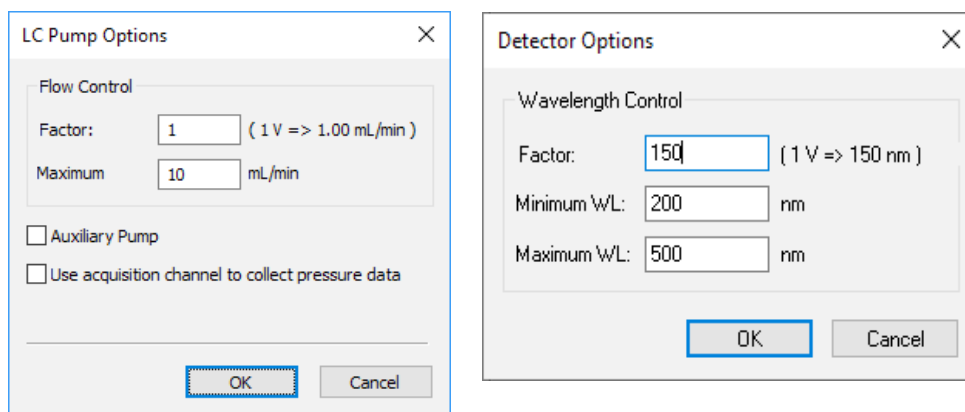
If in the default setting (*Y-AXIS UNITS*: mV and *Y-AXIS MULTIPLIER*: 0.001) a signal of -2mV is displayed and the detector itself displays a signal of 0, the signal can be offset from 2000 to 0 with *Y-AXIS OFFSET*. If the signal is 3 mV, an *Y-AXIS OFFSET* of -3000 has to be entered.

*ANALOG OUTPUT*: The analog output of an A/D converter can be used to drive those devices which are designed for it. The flow of some pumps can be controlled via the analog input, and on some detectors, the wavelength can be set via the analog input. The analog output of the manager 5000/5050 or the IF2/IFU 2.1 has a range of 0-10 Volt.

The smallest possible voltage step for a 12 bit resolution is at 2.44 mv. Please refer to the manual of the A/D converter for current values. To activate the analog output, click the *ANALOG OUTPUT* check box.

*MODE*: Three modes can be selected from the drop-down list: *GENERIC DEVICE*, *LC PUMP* or *DETECTOR*. If *LC PUMP* or *DETECTOR* is selected, the button *OPTIONS* is activated. This opens a configuration menu with settings, which simplify programming in the method setup later on.

*GENERIC DEVICE*: Default mode when using the analog output. The device is controlled by setting the analog output voltage directly based on voltage values entered by user.



**Fig. 71:** Control options for LC pump mode and detector mode

*LC PUMP:* If you want to control a pump with the analog output of the A/D converter, select the mode *LC PUMP*. During method setup the flow instead of the voltage is retrieved when programming the analog output of the A/D converter. Click *OPTIONS* to open the options menu.

*FACTOR:* The factor enables you to program a flow rate instead of a voltage during method setup and makes the software calculate the necessary voltage automatically. Please refer to the manual of the A/D converter for necessary information.

*MAXIMUM FLOW:* Enter the maximum flow rate that is supported by your pump. This mode prevents programming a flow rate higher than the supported flow rate during method setup.

*AUXILIARY PUMP:* Check this option to configure the pump as an auxiliary pump. By default the pump is configured as a part of ClarityChrom® LC gradient system. An auxiliary pump has a separate menu for programming the flow in the method setup.

*USE ACQUISITION CHANNEL TO COLLECT PRESSURE DATA:* Check this option in the case that the analog input of this channel (acquisition part) should be used to collect pressure data. In this case acquired data will be sent to ClarityChrom® as pressure data from this pump.



**Note:** In case that the pump is configured to collect pressure data, please check that the acquisition settings are configured correctly. Note that in this case pressure units are hard-coded to the current pressure units selected by the user (MPa, bar or psi).

*DETECTOR:* If you want to control the wavelength of a detector via analog control, select *DETECTOR* from the drop-down list. During method setup, the wavelength instead of the voltage is retrieved when programming the analog output of the A/D converter. Click *OPTIONS* to open the options menu.

*MINIMUM WL / MAXIMUM WL:* Enter the wavelength range that is supported by your detector. This mode prevents programming a wavelength higher or lower than the supported wavelength during method setup.

When complete, click *OK* to close the window.

If you want to use multiple channels of the A/D converter, you have to perform the configuration for each channel. Please note that analog input and the analog output cannot be used simultaneously.

When complete, click *OK* to close the window. The *OK* button for closing the configuration window is active only after a serial number has been entered.



**Note:** The different configured channels can be added to different instruments. Each channel supports an independent trigger (start) input.

## 7.6.2 Detector connections

Up to four detectors can be connected to the Manager 5000/5050, the IF2/IFU 2.1 or the KNAUER HPLC box.

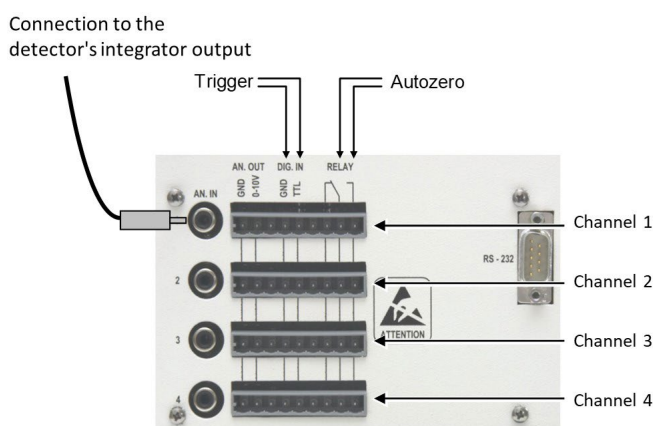
Always use a shielded twisted pair cable to connect each detector to the interface. This minimizes electrical noise. Connect the analog output lines from each detector you want to acquire data from to one of the four analog connections labeled AN.IN 1 through 4.



**Note:** It is not possible to use the cinch connector and the WAGO connector from the same channel for different instruments. They are not independent of each other.



**Note:** After powering up the A/D converter, allow 15 minutes for the electronics to stabilize before running samples that require sensitive measurements.



**Fig. 72:** Cable connections to the Manager 5000/5050 or IF2/IFU 2.1

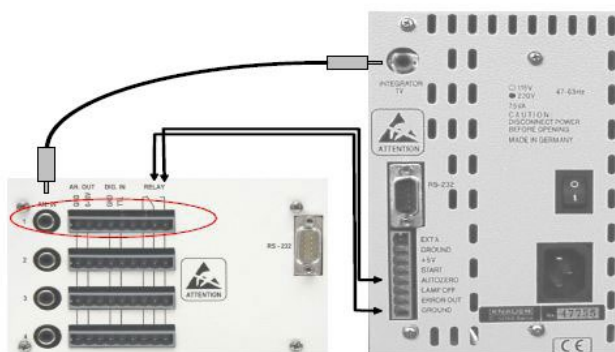
If you want your instrument to trigger the start of data acquisition or to perform an autozero, you must take care for making the trigger signal and autozero connections. Except for triggering via an autosampler and via detector. For autosamplers, a logical trigger is supported (see „Configuration - autosamplers“ on page 67). The digital inputs and outputs used for the connections are situated on WAGO connectors adjacent to the integrator inputs. Each of the WAGO connectors corresponds to one of the data acquisition channels.

### Trigger signal connection

Connect one pole of the trigger cable to one of the connectors labeled DIG. IN / TTL, and the other pole to the connector labeled DIG.IN / GROUND (digital ground). Each of the WAGO connectors corresponds to one of the data acquisition channels.

### Autozero signal connections

The autozero signal cable has to be connected to the NO relay connectors, as depicted in Fig. 73 on page 63. On powering-up, the software automatically selects the output if the analog input of the channel has been configured for data acquisition. Each of the WAGO connectors corresponds to one of the data acquisition channels.



**Fig. 73:** Wiring examples Manager 5000/IF2 and K-2501

The figure shows the connection of a detector to an interface box or the Manager 5000, using the KNAUER K-2501 detector as an example.

## 7.7 Configuration - AZURA® Assistants ASM 2.1L / ASM 2.2L

The AZURA® Assistants ASM2.1L / ASM 2.2L are modular devices that allow combining up to 3 devices (modules). The following devices can be included:

- AZURA® Pump P 2.1S, P 4.1S
- AZURA® Detector UVD 2.1S
- KNAUER valves, all positions available (ASM 2.1L only)
- Valco valves with 2, 6, 8, 10, 12, and 16 positions (ASM 2.1L only)
- KNAUER Valve Unifier VU 4.1 with all available valves (ASM 2.2 only)

### 7.7.1 Configuration rules

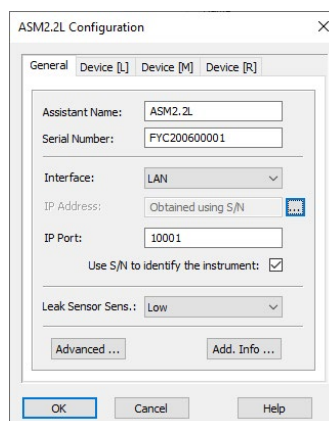
Three pumps are not supported in an assistant. Pumps cannot run in a HPG. An assistant with two pumps and one detector is not supported.

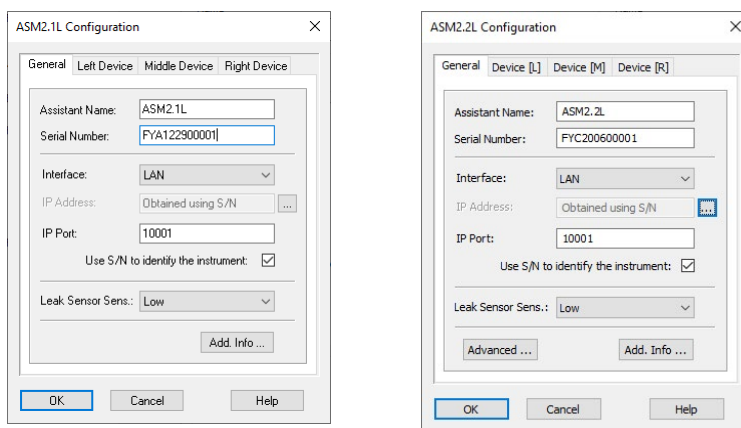
Only one UV detector can be added.

One valve drive can be used as a fraction collector if the appropriate license option is used.

Cascading fraction valves is not supported. Only one fraction valve in an assistant can be configured. This is also applicable if the valves are installed in different assistant housings or the other valves are standalone.

All the devices will be controlled by only one LAN port; a serial control via RS-232 is not implemented.





**Fig. 74:** AZURA® Assistant ASM 2.1L (left) and ASM 2.2L (right) configuration windows, tab **GENERAL**

If one of the modules shall not be used (controlled), it has to be removed from the assistant configuration. In order to do so, the *DEVICE TYPE* has to be set to *NONE* in the respective device. There is no option to disable a configured module later on in the method setup.


The configuration window has four tabs, one for general settings concerning the entire assistant (*GENERAL*) and one for each of the three device positions, *LEFT*, *MIDDLE*, and *RIGHT*.

In the window *SYSTEM CONFIGURATION*, the assistant is displayed as one device with up to three sub-devices. If the assistant is added to an instrument, all configured sub-devices are added.

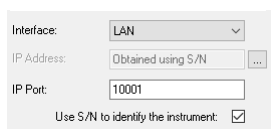
**General** *ASSISTANT NAME:* The name of the assistant appears automatically. You can enter any other descriptive name. This name will appear on the assistant tab when the method setup or device monitor windows are displayed.




**Note:** Use a name which is unique within ClarityChrom®. It is not allowed to configure two devices with the same name.

*SERIAL NUMBER:* If you have transferred the device configuration via , the serial number is already displayed in the window. Otherwise type in the serial number of the instrument.

*INTERFACE:* The assistant only supports LAN connection, only one LAN port for all 3 devices is required.



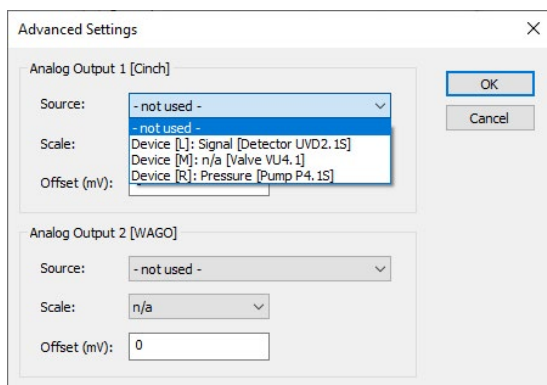
**Fig. 75:** LAN interface dialog

With the  button, the configuration of the entire assistant can be read out and transferred. You can also configure each integrated module via the corresponding tab.

*LEAK SENSOR SENSITIVITY:* Select the leak sensor sensitivity in accordance with your requirements. The choices are *OFF*, *LOW*, *MEDIUM* and *HIGH*.

*ADVANCED...* (ASM 2.2L only): After clicking the *ADVANCED...* button, you can select the source for the analog outputs. Depending on the configured modules, the


detector signal, pump pressure or a permanent 2.5 Volt signal (Valve) can be delivered. The setup allows for signal scale and offset for the detector signal or pump pressure. If the option - *NOT USED* - is selected, the analog output source will not be changed and will deliver the same signal as before. If a source is selected, it will be checked while the instrument is opened and changed if required. When the ASM 2.2L is switched off and on again, the last selected source will be used for the analog outputs. The signal is sent even if the device is not controlled by software.



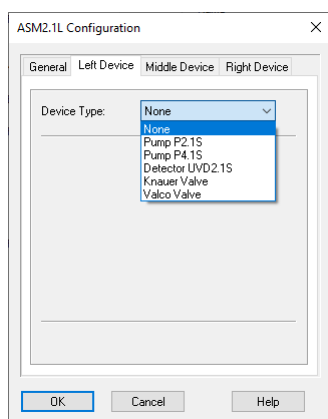
**Fig. 76:** Advanced settings

*ADD. INFO...:* After clicking on the *ADD. INFO...* button, you can enter additional information about the detector.



**Note:** If you have already transferred the configuration of the entire assistant using the  button of the *GENERAL* tab, you don't have to configure the modules of the assistant individually. This is the recommended approach. The automatic configuration eliminates the risk of a faulty configuration. Nevertheless, the manual configuration will be described below.

**Left device** Due to that for all three device positions the same devices and settings can be selected, the options will only be described for the *LEFT DEVICE* tab.



**Fig. 77:** Configuration window left device tab, device type selection

*DEVICE TYPE:* From the drop-down list, select the device that is installed on the left side of the assistant.

**Device type** *PUMP P 2.1S:* If this pump is selected, you can choose the device name (please refer to the device name section below) and the pump head (*10 ML, 50 ML*).

*PUMP P 4.1S*: If this pump is selected, you can choose the device name (please refer to the device name section below) and the pump head (*10 ML*, *50 ML*). For using an HPG, the pump heads must be identical.

*DETECTOR UVD 2.1S*: If selected, you can choose the device name (please refer to the device name section below) and the Y axis units ( $\mu$ AU, mAU, AU). The *FLOW CELL* field allows for entering information regarding the used detector flow cell.

*VALVE VU4.1* (ASM 2.2L only): If selected, you can choose the valve positions and ports, depending on the mounted valve. Please be sure to select the correct values. For a valve in the ASM 2.2L, the option *USE AS A FRACTION COLLECTOR* can be activated (only with *KNAUER FRC* option).

If selected, there are additional options: You can enter the *VIAL VOLUME* (be sure to enter the correct volume) and setup *TUBING* and *SOLVENT RECYCLING*.

Refer to the chapter „Configuration - Fraction collectors“ on page 74 for detailed information. When the option *USE AS A FRACTION COLLECTOR* is already selected for another valve in the assistant, the error message *THE FRACTION COLLECTION OPTION IS ALREADY SELECTED FOR ANOTHER VALVE* will be shown for the next valve.



**Note:** Only one valve in an ASM 2.2L can be configured as a fraction valve. Valve cascading is not supported, also not with valves from other ASM 2.2L or standalone valves.

*KNAUER VALVE (ASM 2.1L ONLY)*: If selected, you can choose the device name (refer to the device name section below) and the number of position. Be sure to select the correct number of position, if you select it manually. Positions *2*, *6*, *12*, or *16* can be selected. For a valve in the ASM 2.1L, the option *USE AS A FRACTION COLLECTOR* can be activated (only with *KNAUER FRC* option).

If selected, there are additional options: You can enter the *VIAL VOLUME* (please be sure to enter the correct volume) and setup *TUBING* and *SOLVENT RECYCLING*.


Refer to chapter „Configuration - Fraction collectors“ on page 74 for detailed information. If for another valve in the assistant the option *USE AS A FRACTION COLLECTOR* is already selected, for the next valve an error message *THE FRACTION COLLECTION OPTION IS ALREADY SELECTED FOR ANOTHER VALVE* will be shown.



**Note:** Only one valve in an ASM 2.1L can be configured as a fraction valve. Valve cascading is not supported, also not with valves from other ASM 2.1L or standalone valves.

*VALCO VALVE (ASM 2.1L only)*: If selected, you can choose the device name (please refer to the device name section below) and the number of position. Please be sure to select the correct number of position, if you select it manually. Positions *2*, *6*, *8,10*, *12*, or *16* can be selected. For a valve in the ASM 2.1L, the option *USE AS A FRACTION COLLECTOR* can be activated (only with *KNAUER FRC* option).

If selected, there are additional options: You can enter the *VIAL VOLUME* (please be sure to enter the correct volume) and setup *TUBING* and *SOLVENT RECYCLING*. Please refer to the chapter „Configuration - Fraction collectors“ on page 74 for detailed information. If for another valve in the assistant the option *USE AS A FRACTION COLLECTOR* is already selected, for the next valve an error message *THE FRACTION COLLECTION OPTION IS ALREADY SELECTED FOR ANOTHER VALVE* will be shown.

*DEVICE NAME*: The default name corresponds to the selected device type. All device names must be unique in an instrument (configuration). Therefore, enter different names for the same device types, e.g. if a high pressure gradient is used. If the configuration of the assistant has been read-out using the  button at the *GENERAL* tab, the software will name devices from the same type automatically with different names.



For valves, a letter referring to the module's position in the assistant (L,M, or R) will be added, e.g. a valve in left position will be named as "ValveL".



**Note:** Use a name which is unique within the instrument (configuration). It is not allowed to configure two devices in an instrument with the same name. This is also applicable, if more than one ASM 2.1L or ASM 2.2L have been configured. Neither the name of the assistant nor the names of the subdevices must have the same name. E.g. if in one assistant a valve is named as „ValveL“, for all other assistants no name „ValveL“ is allowed for a valve subdevice.

**Middle device** Since identical modules and settings can be selected for all three device positions in the assistant, the configuration is only described for the Left Device tab.

**Right device** Since identical modules and settings can be selected for all three device positions in the ass, the configuration is only described for the *LEFT DEVICE* tab.



**Note:** If one of the modules should not be controlled, it must be removed from the ASM 2.1L configuration. There is no option to disable a configured module later on in the method setup.

## 7.8 Configuration - autosamplers

The settings of the other Spark autosamplers are mostly comparable:

- KNAUER Smartline AS 3800
- KNAUER Smartline AS 3900
- AS 3950
- AZURA® Autosampler AS 6.1L
- Spark Marathon
- Spark Midas
- PLATINblue AS-1

The KNAUER Optimas can be controlled via serial port, while the Spark Optimas autosampler is not equipped with a serial port.

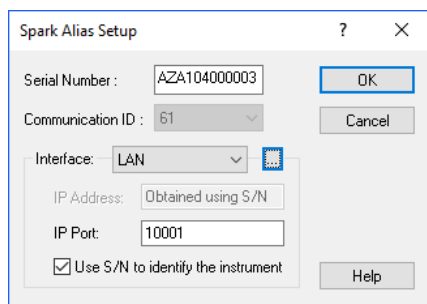
For the Autosampler 3900/KNAUER Optimas/Spark Midas and Triathlon we recommend setting the DIP switch for the serial interface into *OFF* position. This helps preventing communication problems with additionally added interfaces, e.g. a USB serial converter. We recommend accessing the autosampler 3800/Spark Marathon via on-board interface, which is directly installed on the main-board of the computer.



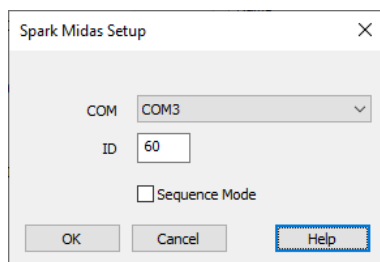
**Note:** More than one autosampler can only be controlled in a LAN network, if all of the autosamplers are running with TCP/IP protocol. AS 6.1L will be delivered with active TCP/IP, AS 3950 or AS-1 may need to be switched. Ask the KNAUER Customer Support for more information on how to switch an autosampler from UDP to TCP/IP. The autosamplers AS 3950 and AS 6.1L additionally use IP ports 80, 2101 and 2362.

The configuration windows for the Spark and KNAUER autosamplers are all practically the same.





**Fig. 78:** Configuration window for autosampler AS 6.1L and AS 3950




**Fig. 79:** Configuration window for the autosampler AS 3900 (Spark Midas) (equal to KNAUER Optimas)




**Note:** The autosampler S 3950 is either equipped with a LAN port or with a serial port.

#### Interface RS-232 (S 3950 only)

**COM PORT** From the drop-down list, select the serial port on your PC where your autosampler is connected. If you click on the  button, the software recognizes the connected and switched-on device automatically. This procedure is recommended.


#### Interface LAN (AS 6.1L / AS3950 only)

**IP ADDRESS:** If the option *USE S/N TO IDENTIFY THE INSTRUMENT* is activated, this input field is grayed out. If you click on the  button, the software recognizes the connected and switched-on device automatically. This procedure is recommended.

**USE S/N TO IDENTIFY THE INSTRUMENT:** This option is activated by default.




**Note:** We highly recommend using the S/N and not the IP address to identify the instrument because devices may automatically receive a new IP address when reset.

**INTERFACE [...]** Click the  button to get a list of all devices (pumps, detectors, etc.) which can be accessed via the selected interface. Select a device and click on *SELECT #* to confirm. The serial number is read directly from the device.

**COM (AS 6.1L / AS3950 only):** From the drop-down list, select the serial port on your PC where your autosampler is connected.

**ID / COMMUNICATION ID:** Enter or select from the drop-down list the ID number for the autosampler in use. For the autosamplers AS 6.1L and AS 3950 it is inaccessibly fixed at 61. For all other devices, the ID can be displayed on the device itself. If the ID on the device and in the software do not correspond, communication is not possible.

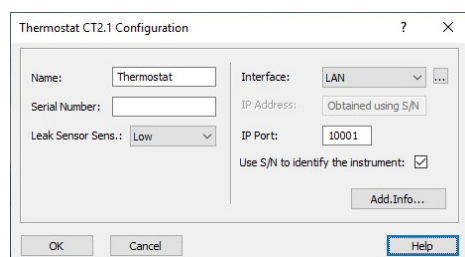
- Autosampler 3800/Spark Marathon: On the device, press keys <F> and <4>. The device display then shows "SERIAL MODE PRESS F0 TO EXIT". Press the key <PROG/END> to show the ID. Values from 1 to 19 are possible. To leave the ID display, press the key <PROG/END> again. To be able to access the autosampler via software, it has to be switched on prior to starting the instrument (login) in the ClarityChrom® and set to serial mode, as described above.
- Autosampler 3900/KNAUER Optimas/Spark Midas: On the autosampler, press the key below SERIAL on the display. This is displayed when the autosampler has been switched on. The autosampler is then in serial mode in which it can be accessed. Consecutively, press <SYSTEM>, <MENU>, and <SERIAL>. An ID between 60 and 69 is possible. To be able to access the autosampler via software, it has to be switched on prior to starting the instrument (login) in the ClarityChrom® and set to serial mode, as described above.
- Autosampler Spark Triathlon: To enter the serial mode, press the keys <MENU> and <SERIAL> on the autosampler. From there you can enter the display with the ID by clicking <SYSTEM>, <MENU>, <COMM>, and <E> (Enter). To be able to access the autosampler via software, it has to be switched on prior to starting the instrument (login) in the ClarityChrom® and set to serial mode, as described above.

*SER. NUMBER* (AS 6.1L / AS3950 only): Type in the serial number of the interface you are using. It is recommended to read out the device via . Then, the serial can be transmitted from the device.

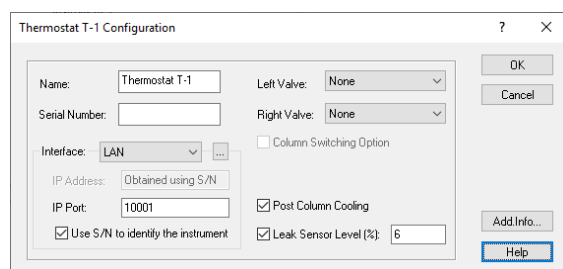
*SEQUENCE MODE* (only KNAUER Optimas / S 3800 / S 3900): The sequence mode allows advanced wash features for the autosampler. This option is not available for the autosamplers AS 6.1L and AS 3950.

When complete, click *OK* to close the window.

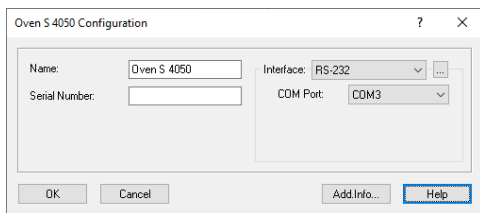
## 7.9 Configuration - column thermostat



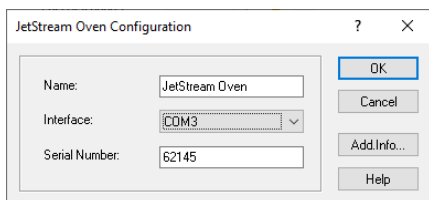
**Fig. 80:** Configuration window for CT 2.1



**Fig. 81:** Configuration window of the PLATINblue T-1



**Fig. 82:** Configuration window for the Smartline 4050



**Fig. 83:** Configuration window of the Jetstream



**Note:** The Jetstream is supported from firmware version B1.17. If the control panel is connected, don't touch any key if the device is started, otherwise the device control will not work.

*NAME:* Enter a descriptive name for the column thermostat. Use a name which is unique within the instrument.




**Note:** Use a name which is unique within the instrument (configuration). It is not allowed to configure two devices in an instrument with the same name.

*INTERFACE* (not for Jetstream): The Column Thermostat CT 2.1, Smartline Oven 4050 and the T-1 can be controlled via RS-232 or LAN (Local Area Network). The settings for these interfaces are different:



**Fig. 84:** Interface RS-232 (left) and interface LAN (right)


**Interface RS-232** *COM PORT:* From the drop-down list, select the serial port on your PC where your oven is connected.


**Interface LAN** *IP ADDRESS* (not for Jetstream): If the option *USE S/N TO IDENTIFY THE INSTRUMENT* is activated, this input field is grayed out. If you click on the  button, the software recognizes the connected and switched-on device automatically. This procedure is recommended.

*USE S/N TO IDENTIFY THE INSTRUMENT* (not for Jetstream): This option is activated by default.




**Note:** We recommend the use of the option *USE S/N TO IDENTIFY THE INSTRUMENT* to obtain the IP address automatically, especially if a DHCP server (e.g. a router) is used. We highly recommend using the S/N and not the IP address to identify the instrument because devices may automatically receive a new IP address when reset.

*INTERFACE [...]* (not for Jetstream): Click the  button to get a list of all devices which can be accessed via the selected interface. Select a device and click on *SELECT #* to confirm. The serial number is read directly from the device.

*SERIAL NUMBER*: If you have read out CT 2.1, PLATINblue T-1 or Smartline 4050 with the  button as described above, the serial number has been added automatically. Otherwise, type in the serial number of the column oven you are using.

*LEAK SENSOR SENS.* (CT 2.1 only): The sensitivity of the leak sensor depends on the selection. Three different settings are available: *OFF* (leak sensor is switched off), *LOW* (low sensitivity), *MEDIUM* (medium sensitivity), and *HIGH* (high sensitivity).

### For the T-1 only

*LEFT VALVE/RIGHT VALVE*: If you have read out PLATINblue T-1 with the , the complete configuration settings have been submitted. You don't have to select a valve type as well. Otherwise, select the valve type from the drop-down list. The options are 6-Port MPOS, 8-Port MPOS, 10-Port MPOS, 6-Port 2POS, 8-Port 2POS and 10-Port 2POS (MPOS means multi-position, 2POS means that the valve can switch between two positions). When the option *COLUMN SWITCHING* is not selected, two different valves can be selected for both sides.

*COLUMN SWITCHING OPTION*: This option can be selected when the same valve type can be selected for both sides. This option allows both valves to be switched at the same time with one signal (program command).

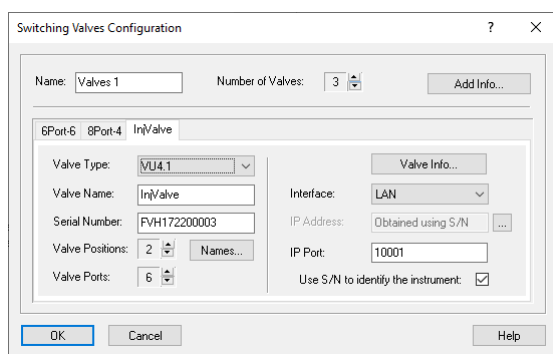
*POST COLUMN COOLING*: If the *POST COLUMN COOLING* is selected, the temperature for the post column cooling can be programmed in the method setup.

*LEAK SENSOR LEVEL [%]*: The sensitivity of the leak sensor depends on the entered value. A low value equals a low sensitivity. A sensitivity value of 0-100 can be entered.

## 7.10 Configuration - switching valves

In the switching valve configuration window, up to 8 valves can be configured as a „group“. The advantage of this procedure is that all configured valves can be programmed from a table in method setup. You can configure the valves individually as well. Every configured valve then receives its own setup window in method setup.

The configuration of the KNAUER valves of the WellChrom series (K-2, K-6, K-12, K-16), Smartline (V2, V6, V12, V16), and AZURA® (V 2.1S) are identical. The AZURA® VU 4.1 supports more options. Check the description of these options.



**Fig. 85:** Configuration window for VU 4.1 and KNAUER switching valves

*NAME*: This is a "group name" for the "device" in which 8 valves can be configured. These valves do not have to be integrated into one housing. This is just a logical sequence. In method setup, this "group name" appears in the *VALVE* tab, while the setup table of the configured valve of this group can be programmed under its name (see below). Enter a descriptive name for the selected valve.




**Note:** Use a name which is unique within the instrument (configuration). It is not allowed to configure two devices in an instrument with the same name. If you enter multiple valves separately, every valve group is named „Valves 1“. Since identical names are not allowed, you have to change the names manually.

*NUMBER OF VALVES*: Enter the number of valves used in a group. The maximum possible number is 8.


*ADD INFO...*: After clicking on the *ADD. INFO...* button, you can enter additional information about the valve group. The additional information entered here is printed out in the device configuration.



**Note:** The following settings must be entered separately for each of the valves. To read out the configuration data (recommended procedure) or enter it manually, select each valve via its tab.

*VALVE TYPE*: Select the correct valve type (KNAUER series). Independently from the selected valve module from the module list, the default valve type is VU4.1. Then click on the  button to read-out the valve. This will transfer the necessary information from the valve drive to the software.

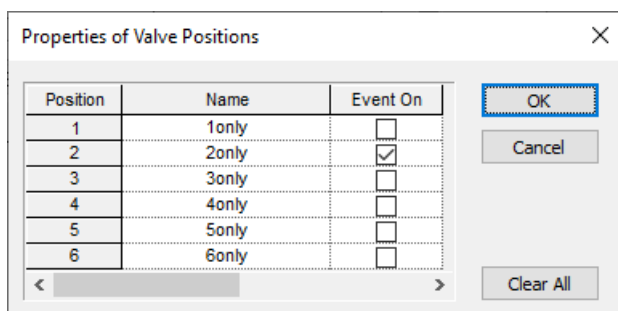
*VALVE NAME*: Enter a descriptive name for the selected valve. Use a name which is unique within the instrument. This name appears then on the tab of the valve in the *INSTRUMENT SETUP* (method window) and in the *INSTRUMENT STATUS* (status window).

*SERIAL NUMBER*: If the valve is read-out using the  button, the serial number is added automatically. Otherwise it must be entered manually.

*VALVE POSITIONS*: If the valve cannot be read-out, select the number of valve positions. Make sure that the number of positions are matching with the corresponding valve.

*VALVE PORTS*: If the valve cannot be read-out, select the number of valve ports. Make sure that the number of ports are matching with the corresponding valve.

*NAMES*: The positions of a valve can be named in a separate menu. If a VU 4.1 is used, additionally for each position an event can be enabled. Both, names and events, will be shown in the method setup's valve time table and in the device monitor.



**Fig. 86:** VU 4.1 position properties

*POSITION*: These are the positions of the selected valve.

*NAME:* You can enter a (descriptive) name for the position. Up to 16 characters are allowed. E.g. for column switching valves you can enter the name of the connected column. This name will be shown in the method setup and also in the device monitor section (max. 8 characters) for the valve.

*EVENT ON:* If you wish to receive a signal if the valve switches to this position, enable the check box. This will send a pulse of about 1 seconds to the Event/Out & Ground pin of the rearward WAGO connector if the VU 4.1 switches to the selected position. There is just one event output for the VU 4.1. That means, the event signal will always be present on the same output pin also if enabled for several positions.



**Note:** If you add multiple valves separately, every valve group is named „Valves 1“ and the individual valves are named „Valve #1“, „Valve #2“, etc. Since identical names are not allowed, you have to change the names manually.

*INTERFACE:* Select the connected interface (LAN or RS-232). For RS-232 you also need to select the COM port number, which is connected to your devices. Click the button to get a list of all devices which can be accessed via the selected interface. Select a device and click on SELECT # to confirm. The corresponding serial number and configuration (number of ports and positions) will be read-out from the device and transferred automatically

**Interface RS-232** *COM PORT:* From the drop-down list, select the serial port on your PC where your valve is connected.

**Interface LAN** *IP ADDRESS* (WellChrom and early Smartline valves do not have a LAN connection): If the option *USE S/N TO IDENTIFY THE INSTRUMENT* is activated, this input field is grayed out. If you click on the button, the software reads out the connected and switched-on device and configuration data can be transmitted automatically. This procedure is recommended.

*USE S/N TO IDENTIFY THE INSTRUMENT:* This option is activated by default. We highly recommend using the S/N and not the IP address to identify the instrument because devices may automatically receive a new IP address when reset.



**Note:** We recommend the use of the option *USE S/N TO IDENTIFY THE INSTRUMENT* to obtain the IP address automatically, especially if a DHCP server (e.g. a router) is used. Otherwise, the IP address could change with each system restart and the right IP address would have to be allocated during device configuration every time.



**Note:** For the KNAUER valve, the interface that is used does not have to be set in the device. The devices automatically recognizes through which interface it is accessed.

*VALVE ADD INFO...:* After clicking on the *VALVE ADD. INFO...* button, you can enter additional information about the valve. The additional information entered here is printed out with the device configuration. When complete, click *OK* to close the window.

## 7.11 Configuration - Fraction collectors



ClarityChrom® comes with a fractionation option from the original manufacturer. However, with the KNAUER exclusive FRC option (former ClarityChrom® Prep), the fractionation option from KNAUER can be used.

In the fraction collector group of the configuration, you will find many modules. The description of the configuration and the programming of the method setup is only valid for the fraction collectors supported by KNAUER. These modules are designated by the additional „Developed by Knauer“ below the „Module Info“. These drivers can only be used, if the FRC license is available, the fractionation options which are exclusive to KNAUER, as described in the method setup, are not available for any other module.

The configuration procedure is the same for all fraction collectors, exclusively supported by KNAUER fractionation options (Smartline 3050, MultiValve FC, valve in ASM 2.1L/ASM 2.2L, Foxy Jr., Foxy R1 and R2, Buechi C-660, Labocol Vario 4000/Plus, and Virtual FC). The appearance of the configuration windows, however, may differ, especially for the MultiValve FC.



**Note:** Only one valve, built-in in the AZURA® Assistant, can be configured as a fraction collector. Valve cascading is not allowed, neither with valves from the same nor from other assistant or with standalone valves.



**Note:** Only one fraction collector can be configured per system. The KNAUER fractionation options can only be used by fraction collectors whose drivers were developed by KNAUER. When configuring a system, please be sure to select only a device which was designated as “Developed by KNAUER” in the “Module Info” column.

In the configuration of the KNAUER Smartline 3050 fraction collector, enable the option *USE DIVERTING VALVE*, because otherwise the valve does not switch from the waste to the collect position.

The solvent recycling has to be activated in a separate menu of the fraction collector configuration. With the exception of the Smartline FC 3050 and the MultiValve FC, a separate KNAUER 6POS valve is necessary. The Smartline FC 3050 comes with a fitting valve. On the MultiValve FC, one of the ports can be defined as a recycling position. Consequently, this valve is not disposable for fractionation. Although peak recycling is laid out in devices like the Smartline 3050, peak recycling is not supported in the Knauer FRC option.

The fraction collector ISCO Foxy Jr can only be accessed if a waste valve has been installed. All ISCO fraction collectors can only be accessed if no other internal program has been loaded or is being executed.



**Note:** If an ISCO Foxy R1/R2 is controlled, the collector’s touch pad is not disabled. Don’t use the panel if the collector is under software control.

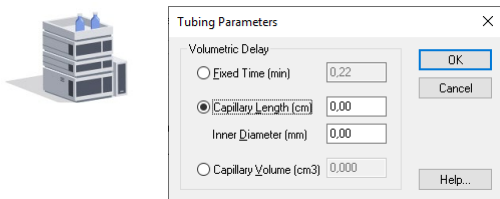
### 7.11.1 Configuration - general settings of fraction collectors

For fraction collectors only supported racks can be used. For those racks the positions of the fraction vials have been programmed. Please check, if the rack selected in the software, matches with the rack enabled in the fraction collector. The transfer of the rack description between software and device may not work for all supported fraction collectors.

Check if the volume of the fractionation vials corresponds with the volume set in the software and change it, if necessary. Do not fill the vials full to the brim to prevent an overflow.



## Tubing parameters



**Fig. 87:** Tubing parameters setup

These settings enable someone to consider the time delay for transporting the sample from the flow cell to the collector valve. If the option *RECYCLING VALVE* is checked, the capillary from the flow cell via the recycling valve to the fractionation valve must be taken into account.

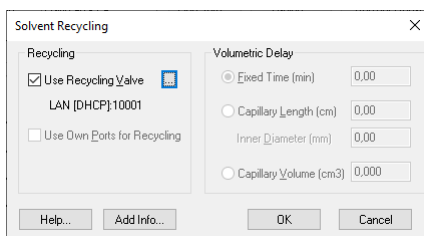
If you activate the option *FIXED TIME* you can enter this time delay directly. This value will be valid, even if the flow rate is changed. Because the time delay changes, the time has to be adjusted in every configuration.

Entering the *CAPILLARY VOLUME* directly or calculating it by entering the *CAPILLARY LENGTH* and *INNER DIAMETER*, the delay time will be adapted to the programmed flow rate of the method.

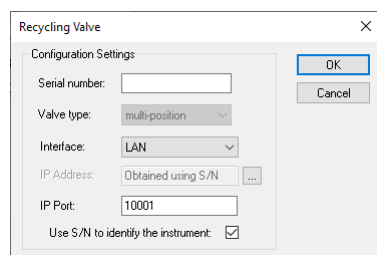


**Note:** The *VOLUMETRIC DELAY*, calculated by flow rate and capillary volume, can only be calculated if the flow rate is fixed over the run time. The flow rate must be entered manually in the FRC setup, it cannot be taken from the pump's setup. Flow gradients are not supported.

## Solvent recycling



**Fig. 88:** Own port recycling valve setup



**Fig. 89:** Configuration of a separate recycling valve

For an optional solvent recycling, an additional recycling valve (KNAUER 6Port MPOS) is required for all fraction collectors beside the Smartline S 3050 and MultiValve fraction collector. Check the option *RECYCLING VALVE*. To configure the



recycling valve press  at the *SOLVENT RECYCLING* window and configure the valve. Peak recycling is not supported.

The settings for the volumetric delay will be displayed without access for changing. The settings are valid as well for the recycling valve as for the fractionation valve. Therefore, the capillary between the recycling valve and the fraction collector should be as short as possible.

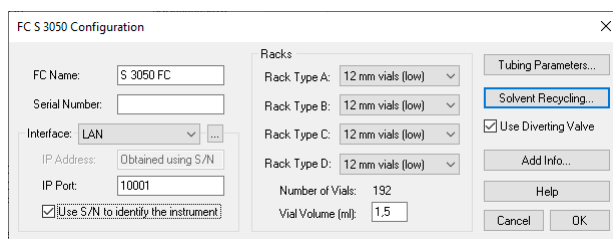
The KNAUER fraction collector S 3050 and the MultiValve fraction collector can also use own ports for recycling. This functionality has to be activated.

*ADD. INFO...:* After clicking on the *ADD. INFO...* button, you can enter additional information about the detector.

When complete, click *OK* to close the window.

The virtual fraction collector is a software option that enables you to optimize the fractionation without additional samples and solvents. By opening and closing the configuration window, it is configured automatically. Still, individual settings are possible.

## 7.11.2 Configuration - Smartline 3050 fraction collector



**Fig. 90:** Smartline 3050 FC configuration window

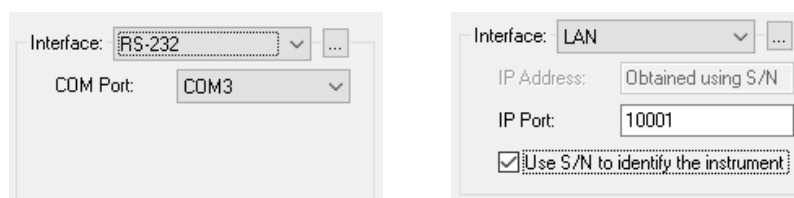
*NAME:* Enter a descriptive name for the fraction collector. Use a name which is unique within the instrument.



**Note:** Use a name which is unique within the instrument (configuration). It is not allowed to configure two devices in an instrument with the same name.

*SERIAL NUMBER:* Type in the serial number of the collector you are using.

*INTERFACE:* The Smartline S 3050 can be controlled with RS-232 and LAN (Local Area Network). The settings for these interfaces will be different:



**Fig. 91:** Interface RS-232, Interface LAN

**Interface RS-232 COM PORT:** From the drop-down list, select the serial port on your PC where your S 3050 is connected.

*LAN IP Address:* Enter the IP address of the S 3050. This can either be a numerical IP address or the network name of the S 3050.

*IP PORT:* The IP Port number used for communication with the S 3050 can be entered here.

*USE S/N TO IDENTIFY THE INSTRUMENT:* Activate this option to search for the IP address of the S 3050 with the help of the serial number. This option is recommended for a LAN connection with automatic address allocation (e.g. DHCP) and for which the address could change with every switching on of the device.

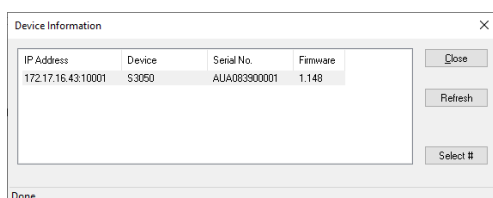


**Note:** The communication port (RS-232 or LAN) has to be set with a switch on the rear of the fraction collector S 3050.



**Note:** We recommend the use of the option *USE S/N TO IDENTIFY THE INSTRUMENT* to obtain the IP address automatically, especially if a DHCP server (e.g. a router) is used. Otherwise, the IP address could change with each system restart and the right IP address would have to be allocated during device configuration every time.

*INTERFACE [...]:* Click the  button to get a list of the devices that are already installed. Select a device and click on *SELECT #* to confirm. The corresponding configuration information, e.g. the serial number, are read out by the device.



**Fig. 92:** Device information window S 3050

1. Click the *REFRESH* button to update the list of found devices.
2. Click on *SELECT #* to select a device. The serial number as well as any additional information for the selected device will then be automatically entered into the configuration dialog.
3. When complete, click *CLOSE* to exit the dialog and return to the system configuration window.

*RACK TYPE:* Select the desired rack type(s) from the drop-down list(s) for all positions A-D.

*NUMBER OF VIALS:* The Vials number will be displayed automatically according to the rack type.

*VIAL VOLUME:* The rack depended value will be displayed automatically. However, you are allowed to overwrite it that the volume matches with the volume of your vials. If any fraction is larger than the set volume, the next free collection position will be used for continued collection to prevent, that a vial will be overfilled.



**Note:** Make sure, that in the configuration the same *RACK TYPE* is selected as in the collectors setup and the *VIAL VOLUME* corresponds with the real volume of the vials you use.

*TUBING PARAMETERS / SOLVENT RECYCLING:* This button opens an identical dialog window for each collector separately. The window is described in the chapter „Configuration - general settings of fraction collectors“ on page 74.

*USE DIVERTING VALVE:* Activate the option *USE DIVERTING VALVE* to switch the valve from the waste to the collect position. Otherwise, the collector arm would move into the right position but the fraction would not be collected.

### 7.11.3 Configuration - KNAUER MultiValve fraction collector



**Fig. 93:** MultiValve fraction collector configuration window

**Fig. 94:** Fraction valve in ASM 2.1L

One or more KNAUER valves can be used as a fraction collector. Using a valve allow a practically unlimited fraction volume while fraction collectors only allow for a limited number of different fraction vials. A valve needs less space than a fraction collector. The limited number of fraction positions of a valve can be increased by cascading valves.

The configuration of a fractionation valve in a ASM 2.1L is similar. Only one valve, built-in in the AZURA® ASM 2.1L, can be configured as a fraction collector. Valve cascading is not possible, neither with valves from the same ASM 2.1L nor from other ASM 2.1L or with standalone valves.

*FC NAME:* You can enter a desired name for the MultiValve fraction collector. The default name is „MultiValve FC“.

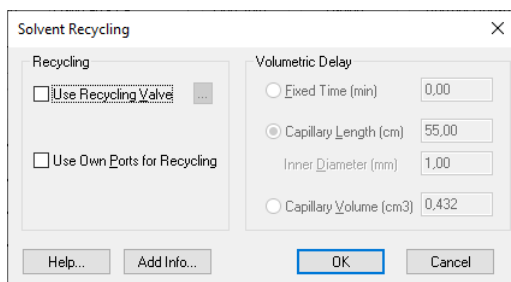


**Note:** Use a name which is unique within the instrument (configuration). It is not allowed to configure two devices in an instrument with the same name.

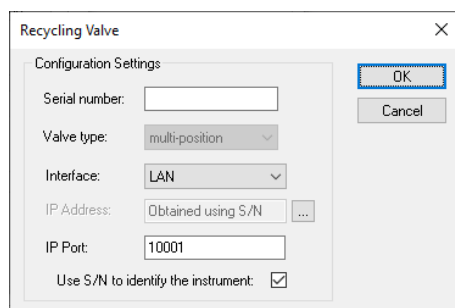
*TUBING:* This button opens an identical dialog window for each collector separately. The window is described in the chapter „Configuration - general settings of fraction collectors“ on page 74.

Note, that also for cascaded valves only one tube volume/dealy time can be set. Therefore, cascaded fraction valves are not useful for low flow rates. Keep tubes between the valves as short as possible.

**SOLVENT RECYCLING:** With the KNAUER MultiValve fraction collector an additional recycling valve or an own port of the fraction valve can be used for solvent recycling. If an own port is selected, automatically the last but one port of the fraction valve will be selected; the last port is defined as waste port.

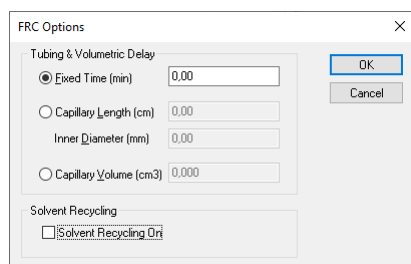


**Fig. 95:** Own port recycling valve setup



**Fig. 96:** Configuration of a separate recycling valve

**OPTIONS (FRC valve in ASM 2.1L only):** the settings for tubing parameters and activation of a solvent recycling port are available in the *OPTIONS* menu.



**Fig. 97:** Settings for tubing parameters

**NUMBER OF VALVES:** Enter the number of valves which build up the MultiValve fraction collector. The maximum number of valves is 32. All valves will be configured as one fraction collector. The number of fraction positions will be counted from the first configured valve. If two 12-position valves will be cascaded, the first valve includes the fraction position 1-11, Port 12 of the first valve must be connected with the input port of the second valve.

The port 1 of the second valve is fraction position 12, port 11 the last fraction position, 22. Port 12 of the second valve is the waste port. If solvent recycling with own port is selected, port 11 of the second valve is defined as solvent recycling port. In this case port 10 is the last fraction position 21.

*VIAL VOLUME* [ml]: Make sure that the vial volume is set correctly to prevent the vials from overflowing. As soon as the fraction volume exceeds the set limit, the collection is continued in the next free vial. This can only be calculated if the flow rate is fixed over the run time. Since the actual collection volume may be slightly larger, the vial should never be filled completely.



**Note:** Make sure, that the value for the *VIAL VOLUME* matches with the volume of your fractionation vials. The preset volume does not necessarily match the volume of the vials that you use.

*NUMBER OF VIALS*: The number of vials corresponds to the number of all ports of the selected valve(s) which can be used for fractionation. Always the port with the highest number is reserved for Waste. In case of valve cascading, this port is reserved for the connection to the next valve; the Waste port is the last port of the last configured valve.

If solvent recycling with own port is enabled, the recycling port is last but one; therefore, one port less is available for fractionation and shown here. In case of valve cascading, the recycling port is from the last configured valve.

*VALVE #*: Each involved valve has to be configured separately. The number of valve tabs is given by the set number of valves. Select the tab of a valve to open the corresponding valve setup.

*SERIAL NUMBER*: Each device has a unique serial number. If the device was read-out using the  button, the serial number is filled automatically. Otherwise you need to enter the serial number manually. The correct serial number is mandatory for communication.

*VALVE NAME*: Valve name appears automatically. The first valve is named as „Valve #1“, in case of valve cascading the second valve is named as „Valve #2“ etc.

*VALVE TYPE*: The correct number of valve positions will be transferred automatically into the software if the device was read-out using the  button. Otherwise select the correct position number of your valve.

*VALVE PORTS*: If the valve cannot be read-out, select the number of valve ports. Make sure that the number of ports are matching with the corresponding valve.

*INTERFACE*: Select the connected interface (LAN or RS-232). For RS-232 you also need to select the COM port number, which is connected to your devices. Click the ...-button to get a list of all devices which can be accessed via the selected interface. Select a device and click on *SELECT #* to confirm. The corresponding serial number and configuration (number of ports and positions) will be read-out from the device and transferred automatically.

Interface *RS-232 COM PORT*: From the drop-down list, select the serial port on your PC where your valve is connected.

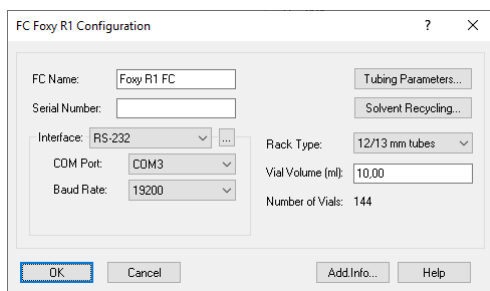
Interface *LAN IP ADDRESS* (WellChrom valves do not have a LAN connection): If the option *USE S/N TO IDENTIFY THE INSTRUMENT* is activated, this input field is grayed out. If you click on the button, the software reads out the connected and switched-on device and configuration data can be transmitted automatically. This procedure is recommended.

*USE S/N TO IDENTIFY THE INSTRUMENT*: This option is activated by default. We highly recommend using the S/N and not the IP address to identify the instrument because devices may automatically receive a new IP address when reset.

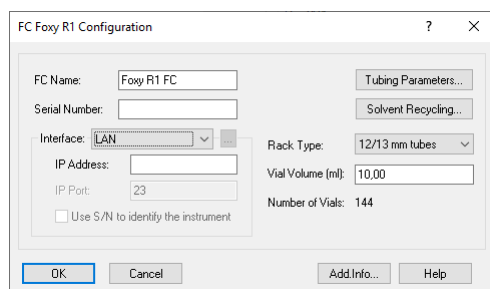


**Note:** We recommend the use of the option *USE S/N TO IDENTIFY THE INSTRUMENT* to obtain the IP address automatically, especially if a DHCP server (e.g. a router) is used. Otherwise, the IP address could change with each system restart and the right IP address would have to be allocated during device configuration every time.

## 7.11.4 Configuration - Foxy R1 / R2 Fraction Collectors



**Fig. 98:** Configuration window Foxy R1 FC (Foxy R2 FC)



**Fig. 99:** Configuration window LAN, Foxy R1 FC (Foxy R2 FC)

**NAME:** Enter a descriptive name for the fraction collector. Use a name which is unique within the instrument.



**Note:** Use a name which is unique within the instrument (configuration). It is not allowed to configure two devices in an instrument with the same name.

**SERIAL NUMBER:** Type in the serial number of the collector you are using.

**RACK TYPE:** Select the type of the rack you want to configure from the drop-down list. The available choices depend on the individual fraction collector. Please make sure, that in the configuration the same rack type is selected as in the collector's setup. If the number of vials of the selected rack type is higher than for the rack type, selected in the collector, a message *CANNOT ESTABLISH COMMUNICATION" WILL BE SHOWN.*



**Note:** Make sure, that in the configuration the same rack type is selected as in the collector's setup.

**NUMBER OF VIALS:** The vials number will be displayed automatically according to the rack type.

**USE RFID:** The fraction collector R2 allows identifying the rack type using RFID technology. If this option is enabled, the driver will read-out the rack type from the collector.

**VIAL VOLUME:** A vial volume that is common for the selected rack type is displayed. However, it can be overwritten. Make sure that the vial volume is set correctly to prevent the vials from overflowing. As soon as the fraction volume exceeds the set limit, the collection is continued in the next free vial. This can only be calculated if the flow rate is fixed over the run time. Since the actual collection volume may be slightly larger, the vial should never be filled completely.



**Note:** Make sure, that the value for the vial volume matches with the volume of your fractionation vials.

*SERIAL PORT:* From the drop-down list, select the serial port on your PC where your fraction collector is connected. The LAN interface is currently not supported.

*SERIAL PORT [...]:* Click the [...] to open a window which shows the connected devices and their current firmware version. It does not allow getting any configuration information from the device, as serial number or rack type.

*BAUD RATE:* Do not change the preset data rate of 19200 baud. Otherwise, stable communication is not possible.

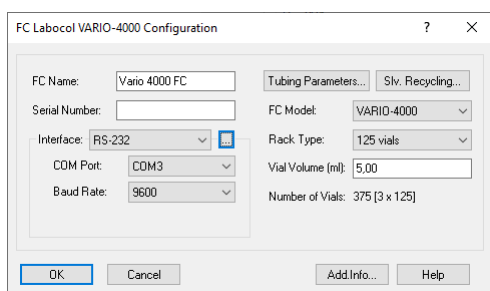
### LAN configuration

The Foxy R1 or R2 FC can only work with a fixed IP address. You can only insert the fixed IP address of the instrument. The [...] button will be inactive after selecting LAN.

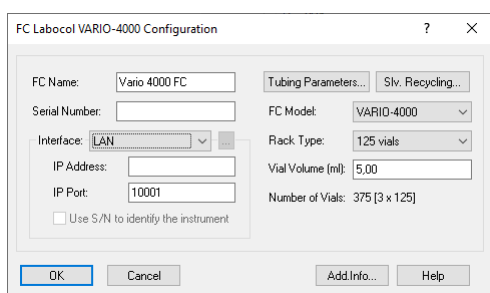


**Note:** The touch pad of the Foxy R1/R2 FC will NOT be BLOCKED if the device will be controlled by software. Therefore it is highly recommended, not to use the touch pad under software control. This is equally valid when switching the Collect/Waste valve or moving the collector arm via the touchscreen. The software cannot recognize inputs via the touch pad. This causes the software to omit the collected fractions when opening the *DEVICE MONITOR - SHOW RACK* and to display a wrong vial position for all following collected fractions.

## 7.11.5 Configuration - Labocol Vario 4000 / 4000 Plus



**Fig. 100:** Configuration window Labocol Vario 4000 RS-232



**Fig. 101:** Configuration window Labocol Vario 4000 LAN

*NAME:* Enter a descriptive name for the fraction collector. Use a name which is unique within the instrument.



**Note:** Use a name which is unique within the instrument (configuration). It is not allowed to configure two devices in an instrument with the same name.

*FC MODEL:* Select the correct model of the Labocol fraction collector. At the drop down menu you can select the between Vario 4000 and Vario 4000 Plus. The software cannot recognize, which model is connected.

*SERIAL NUMBER:* Type in the serial number of the collector you are using.

*RACK TYPE:* Select the type of the rack you want to configure from the drop-down list. Only racks with 20, 24, 39, 80 and 125 vials are supported. The option for free definition of vial position is not supported. All rack must have the same type, a mixed configuration is not supported.



**Note:** Please make sure, that in the configuration the same rack type is selected as in the collector is installed.

*NUMBER OF VIALS:* The vials number will be displayed automatically according to the selected rack type.

*VIAL VOLUME:* A vial volume that is common for the selected rack type is displayed. However, it can be overwritten. Make sure that the vial volume is set correctly to prevent the vials from overflowing. As soon as the fraction volume exceeds the set limit, the collection is continued in the next free vial. This can only be calculated if the flow rate is fixed over the run time. Since the real collection volume may be slightly larger, the vial should never be filled completely.




**Note:** Make sure, that the value for the vial volume matches with the volume of your fractionation vials.





**Note:** The communication interface, the fraction collector should use, can be set via web interface of the fraction collector; refer to the devices manual. The web server is also accessible via LAN, if the RS-232 port is selected for communication with the software. The device driver supports RS-232 and LAN (Winsock) via DHCP or fixed IP address. Due to that option *USE S/N TO IDENTIFY THE INSTRUMENT* is not available, using a fixed IP address is recommended.

*SERIAL PORT:* From the drop-down list, select the serial port on your PC where your fraction collector is connected.

*SERIAL PORT [...]:* Click the [...] to open a window which shows the connected devices and their current firmware version. It does not allow getting any configuration information from the device, as serial number or rack type. Using the  button will switch the device in remote.

*BAUD RATE:* Do not change the preset data rate of 9600 baud. Otherwise, stable communication is not possible.

*LAN configuration:* The  button is not accessible, if LAN is selected as interface.

*LAN IP Address:* Enter the IP address of the device. Due to that the device cannot be read-out via the  button, it is highly recommended to use a fixed IP address instead the DHCP option.

*IP PORT:* The default IP Port number is 10001. It must match with the IP port entered in the device's web interface.

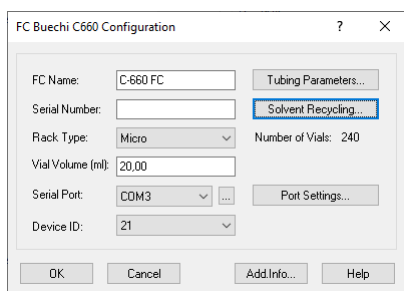
*USE S/N TO IDENTIFY THE INSTRUMENT:* This option is not available for the Vario 4000/4000 Plus.



**Note:** Please note that the touch pad of the Foxy R1/R2 FC will NOT be blocked if the device will be controlled by software. Therefore it is highly recommended, not to use the touch pad under software control. The software cannot recognize inputs via the touch pad. This causes the software to omit the collected fractions when opening the *DEVICE MONITOR - SHOW RACK* and to display a wrong vial position for all following collected fractions.



## 7.11.6 Configuration - Other fraction collectors



**Fig. 102:** Configuration window for Buechi C-660, Foxy Jr., and Virtual FC

*NAME:* Enter a descriptive name for the fraction collector. Use a name which is unique within the instrument.



**Note:** Use a name which is unique within the instrument (configuration). It is not allowed to configure two devices in an instrument with the same name.

*SERIAL NUMBER:* Type in the serial number of the collector you are using.

*RACK TYPE:* Select the type of the rack you want to configure from the drop-down list. The available choices depend on the individual fraction collector.



**Note:** Please make sure, that in the configuration the same rack type is selected as in the collector's setup.


*NUMBER OF VIALS:* The vials number will be displayed automatically according to the rack type.

*VIAL VOLUME:* A vial volume that is common for the selected rack type is displayed. However, it can be overwritten. Make sure that the vial volume is set correctly to prevent the vials from overflowing. As soon as the fraction volume exceeds the set limit, the collection is continued in the next free vial. This can only be calculated if the flow rate is fixed over the run time. Since the actual collection volume may be slightly larger, the vial should never be filled completely.



**Note:** Make sure, that the value for the vial volume matches with the volume of your fractionation vials.

*SERIAL PORT:* From the drop-down list, select the serial port on your PC where your fraction collector is connected.


*SERIAL PORT [...]:* Click the  button to get the configuration information of the instrument connected to the selected interface. Select your device by a mouse click and click then on the *SELECT #* button.

*DEVICE ID (Buechi C-660 only):* From the drop-down list, select the device ID of the connected fraction collector. Read the user manual for the corresponding fraction collector to get more information about the device ID.

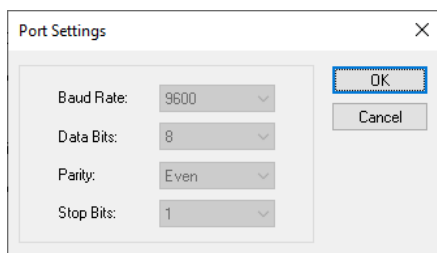
*USE RFID:* If your fraction collector supports this function, check the box to allow for automatic recognition of the rack by RFID chip.

*PORT SETTINGS...:* For some devices you can set the configuration of the serial communication port. Be sure, that it matches with the port settings on the device. Read the user manual for the corresponding fraction collector to get more information about the required settings.

## 7.12 Configuration - completing instruments

To use the devices configured in an instrument, they have to be added to the instrument using the  button (*ADD SELECTED (SUB) DEVICES*). When using a PDA detector or an installed GPC option, the corresponding instrument type has to be selected. For further information, refer to the chapter „Configuration - instrument type“ on page 85.

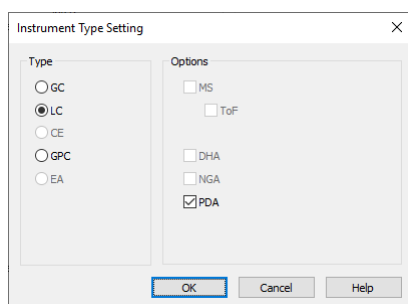
A device can only be added to one instrument. If a device has been added to an instrument, the instrument name will be shown on the left-handed side of the configuration window in the column used.



**Fig. 103:** Port settings

## 7.13 Configuration - instrument type

Select the instrument type from the drop-down list. It depends on the license options on your USB hardware key (dongle). To control a GC system, select the option *GC*, for an (HP)LC system select *LC*. If the system includes a PDA detector or a detector with scan functionality, enable the PDA check box. If an instrument type is selected, ClarityChrom® will check if the selected license options are available. If not, an error message will be shown, that the license options/extensions must be purchased.



**Fig. 104:** Instrument Type selection



**Note:** The setting is individual for each ClarityChrom® instrument.

## 7.14 Configuration - device (start input)

To start all devices in a run at the same time (synchronous start), the external start digital input must be selected. Normally the start signal (trigger) will be sent by the injection device (autosampler, manual injection valve, electrically driven injection valve...). In the device section of the configuration window, use *EXT. START DIG. INPUT* to select the device that receives the start / trigger signal. If no device is selected here, you cannot run a sequence.

All devices with a start input are displayed in the device. Make sure that the start input of the selected device is connected to the start/trigger output of the injection device with a start/trigger cable. Select a number under *NUMBER*. A/D converters have often a start/trigger input for every channel (KNAUER A/D converters have 4 channels, means 4 start inputs).

Make sure to select the correct input number. All other devices have just one start/trigger input. If -- is displayed, the start/trigger input is not active. This means that the trigger signal cannot be detected.

If the configured autosampler (*SAMPLER #*) is listed, you can use it for a "logical" trigger. In this case a start/trigger cable is not required.

If the trigger is connected to a KNAUER device, the trigger length must be 1 second in minimum. Shorter short circuits may not start the data acquisition.

If the system does not include an injector or any other device capable of sending a start/trigger signal and you still want to use sequences, you can resort to the special functionalities of a virtual detector. Configure a virtual detector and add it to your instrument. Select the virtual detector (VD) from the menu *EXT. START DIG. INPUT OFF*. If the virtual detector is selected for the start input, it will send in a sequence a logical trigger, if all devices have sent a Ready status.

The AZURA® VU 4.1 Start Input is not supported as a physical input. All KNAUER valve drives work same as the trigger for the virtual detector. If a sequence is started, a run will be started if all devices send *READY* status.

The figure shows three screenshots of the 'Data Inputs & Outputs' configuration window. Each window has a title bar 'Data Inputs & Outputs' and two columns: 'Device' and 'Number'.  
 - The first screenshot shows 'Ext. Start Dig. Input' set to 'P6.1L' and 'Ready Dig. Output' set to 'P6.1L'. The 'Number' for the start input is '1'.  
 - The second screenshot shows 'Ext. Start Dig. Input' set to 'Sampler 1' and 'Ready Dig. Output' set to 'P6.1L'. The 'Number' for the start input is a dropdown menu with a refresh icon.  
 - The third screenshot shows 'Ext. Start Dig. Input' set to 'VD' and 'Ready Dig. Output' set to 'P6.1L'. The 'Number' for the start input is a dropdown menu with a refresh icon.

**Fig. 105:** Devices for the *EXT.START DIG.* input: P 6.1L, autosampler, virtual detector



**Note:** Without a device, selected for the start signal, no sequence can be started. A number must be selected to activate the start input. If a device is selected, the start/trigger input of the device must be connected with the start/trigger cable. If the autosampler is selected, the trigger cable must not be connected.

The *READY DIG. OUTPUT* allows to send a signal from a device, e.g. to control an autosampler, which is not supported in ClarityChrom® software. Under *NUMBER* select the desired digital output of the device. If a sequence is running, the signal will be sent if no run is started. During a run, the signal will not be sent.

## 7.15 Configuration - units setup

The units setup allows for setting units for different parameters. As an example, the units for the flow or pressure trace can be selected as well as the base for the

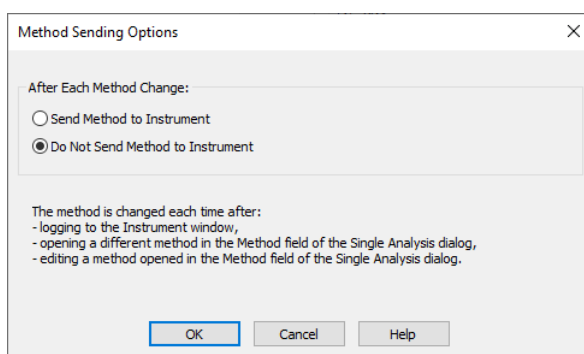
area calculation of peaks, The units for the KNAUER detector signal can only be selected in the corresponding detector configuration.

## 7.16 Configuration - method sending

For a detailed description of the configuration, refer to the „Basic clarity reference guide“ chapter 1.1.3 - Configuration. In particular, pay attention the options which are accessible under *METHOD OPTIONS*. This button opens the *INSTRUMENT METHOD SENDING* dialog.

Since the method settings are not sent to the devices directly before starting a chromatographic run, three other points of time are set for this procedure: when the Instrument window is opened, when a saved method file is opened, and when changes in the method setup dialog are confirmed. (Additionally, it is possible to manually send the device parameters by clicking *SEND METHOD* in the *INSTRUMENT WINDOW, METHOD... SETUP* or the *SINGLE ANALYSIS WINDOW*).

In the setup it can be selected if the settings should be send automatically, or if the settings never should be sent to the devices automatically.



**Fig. 106:** Instrument method sending



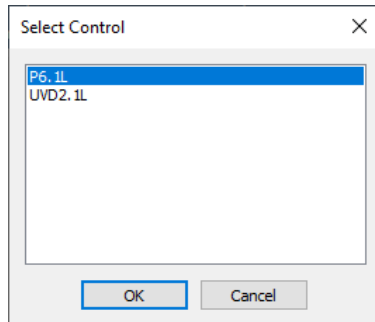
**Note:** This setting can be made for each ClarityChrom® instrument (system) individually.



**Note:** The setting is common to all instruments (GC/LC/AS devices) attached to the same ClarityChrom® instrument.

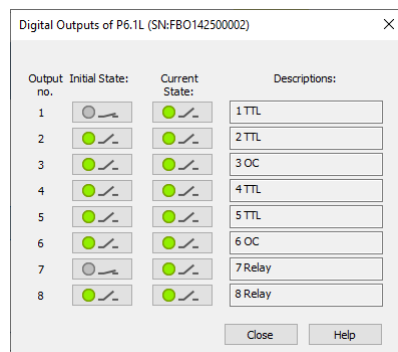
## Digital outputs

The digital outputs available on the rear panel of the devices can be set via *METHOD SETUP* or directly accessed in this menu. In the main window, click *DIGITAL OUTPUTS* to open a list of devices. If the configuration only includes one device with digital outputs, the instrument selection will not be shown.



**Fig. 107:** Instrument selection for digital outputs

Select the desired device to open the corresponding digital output dialog window.



**Fig. 108:** Setting of digital outputs

## 8. Setup - systems and instruments

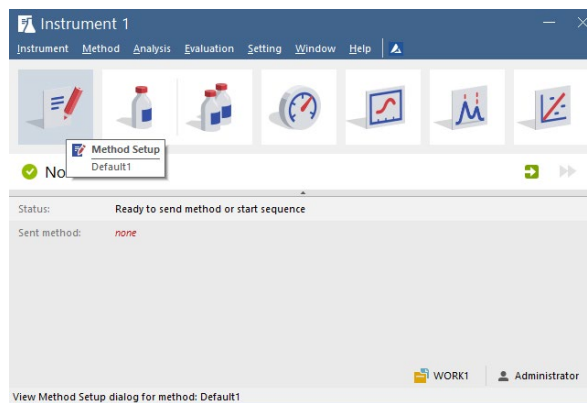
This chapter describes the commands of the Instrument window - the fundamental window for chromatogram measurement and evaluation. The station allows for up to four Instrument windows to be displayed at one time. The number of displayed instruments may exceed the number of licenses. The excess instruments may not be used for data acquisition.



**Note:** The unconfigured instruments can be used for offline data analysis. Methods cannot be created or changed; this requires, that the devices to be controlled are added to this instrument.

This chapter will mainly focus on the control of KNAUER devices. For additional and general information see the „Clarity reference guide“, chapter 2 Instrument.

To open or display an instrument, invoke the command from the login sub menu or click on its icon in the main ClarityChrom® window. The instrument name is taken from configuration, where you can set it.



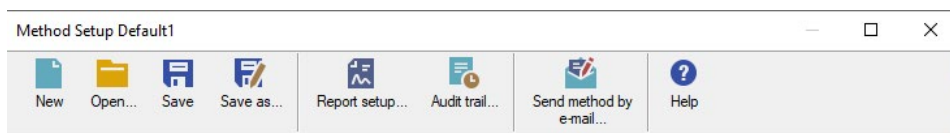
**Fig. 109:** Instrument window

The instrument window is the main window to work with the instrument. At the upper part you can create the method, perform injections, create sequences, direct control of the devices, access to the current data, open chromatograms and create calibration. By scrolling over the icons you receive the information of the function.

Below these icons you have access to send the method, start single run or sequences, stop run or abort run.

Additionally you get the information of the actual run, the project and the logged in user.

Clicking on the *METHOD SETUP* button will open the method setup window. At the upper part, there are the icons for create a new method, open an existing, save and save as the method. Create a report, open the audit trail, send the method or click on help.



**Fig. 110: Top of the method setup window**

*TITLE BAR:* The actual method name.

*NEW:* Create a new method.

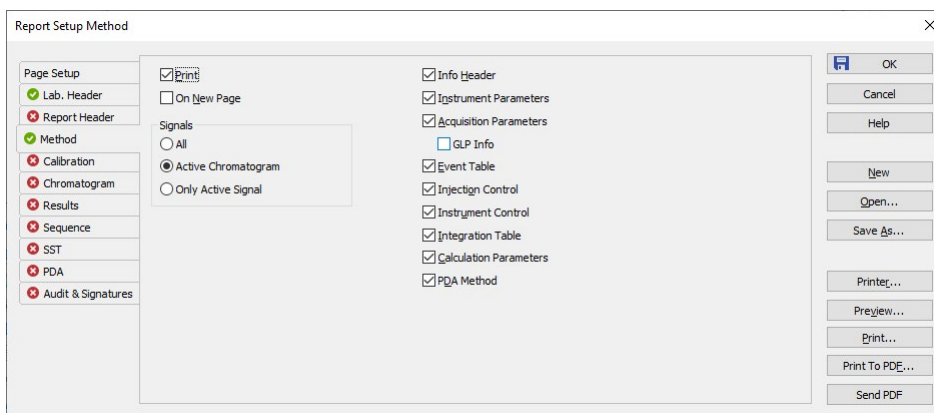
*OPEN:* Open an existing method.

*SAVE / SAVE AS:* save the actual method.

*REPORT SETUP:* In this dialog, the report style can be selected, the printer can be configured, and the print can be initiated. The report style displayed depends on which location the dialog will have been opened from. The styles may differ (e.g., between the *CALIBRATION* window and the *CHROMATOGRAM* window).

Please note that you can open or print a report with chromatogram only from the chromatogram window. If you open or print a report from the method window, only the method relevant details are displayed or printed.

The station is supplied with pre-set report styles that are distributed among all windows that contain printing reports commands. These styles may be modified, copied, relocated or replaced with user specified styles. The sequence of report elements is processed in the same order in which it is shown in the *REPORT SETUP* window. The order of the report blocks in the report can be changed if the blocks will be moved with the mouse (hold left mouse key) on the setup window.



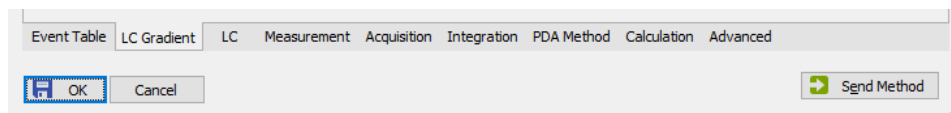
**Fig. 111: Report setup window**

For general description see the „Clarity reference guide“, chapter 8 - Report Setup.

*AUDIT TRAIL:* Opens the audit trail file of this instrument.

*SEND METHOD BY-EMAIL:* Here you can send the saved method by mail if Microsoft Outlook is already configured on the PC.

*HELP:* Opens the online help file related to the actual window tab.



**Fig. 112: Bottom of the method setup window**

**OK:** Accepts the entered settings, saves the method and closes the method setup.

**CANCEL:** Closes the window without accepting the entered settings.

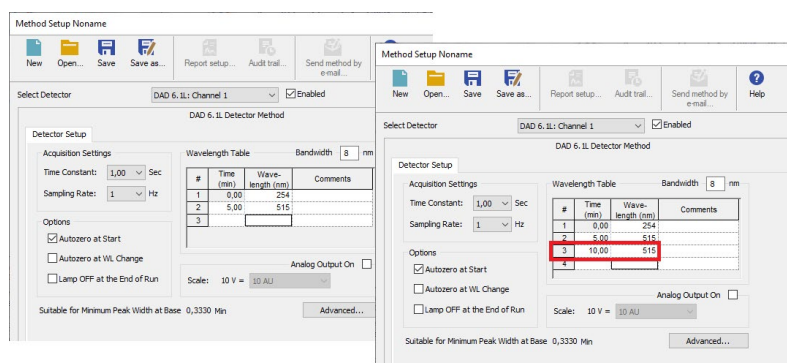
**SEND METHOD:** All settings of the currently opened method will be sent to the connected instruments and there become active. This causes all devices to run with the settings of the first program line. The method, however, will not be processed and no run will be started.

### Duration of of a time program

Time programs for modules will end after the last line in the program table, independently from the global run time (data acquisition). To prevent this, a line with the run time and the desired value must be programmed.

Example: Fig. 113 on page 91 shows a situation where the detector wavelength changed after 5 min, but returned to the starting wavelength after a few seconds. If the run time in the *MEASUREMENT* tab is set to 10 min and you wish to acquire the signal from 5 to 10 min at the programmed wavelength, add a line with the run time in the last line of the table.

This is suitable for all devices, such as column thermostats, valves etc.

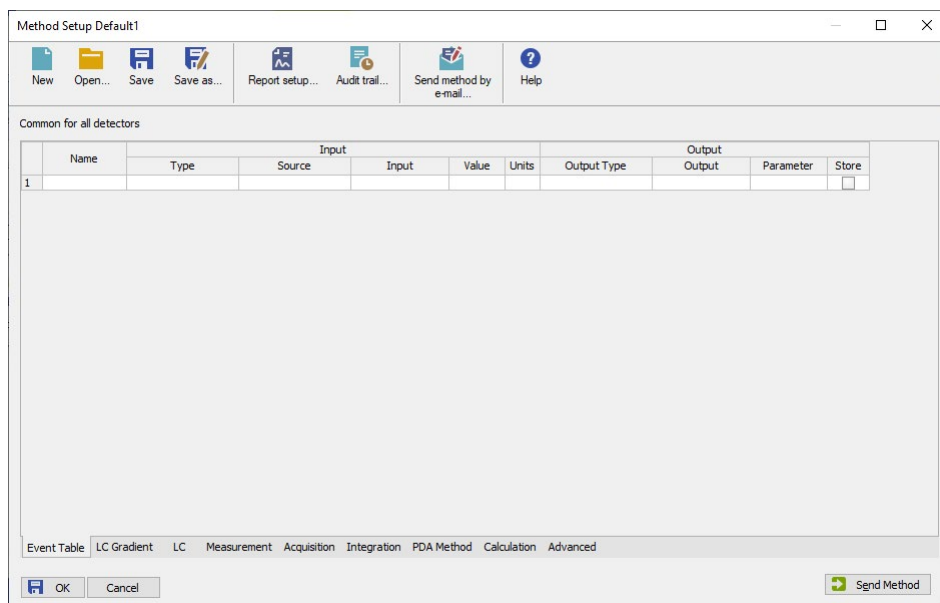


**Fig. 113: Program table, run time extension**

### Event table

The most left hand tab involves the event table. For details refer to the „Clarity reference guide“, chapter 2.5.1 Method - Event Table.





**Fig. 114:** Event table

Most KNAUER devices are equipped with outputs which can be controlled in the method by time or monitoring different statuses. That means, the digital outputs can be activated or deactivated e.g. at a desired run time or signal-level dependent. The digital outputs can be managed in the event table.

Any row of the event table must be filled out strictly from left to right. Only after a name for the event has been entered do the following drop-down lists become active. They define a system status in which the event (i.e. an action) should be performed. Afterwards, they define the action, e.g. which digital output switches which device.

## 8.1 Autosampler

The autosampler can be controlled via sequence or single analysis. The vial number and the injection volume must be entered either in the sequence table or the single analysis window.

If a sequence is used, it must be set Active (Sequence - Options); this is the default setting. This manual only describes the control of the AS 6.1L / AS 3950. The settings of the other Spark autosamplers are mostly comparable.

- KNAUER Smartline AS 3800
- KNAUER Smartline AS 3900
- AZURA® Autosampler AS 6.1L
- AS 3950
- Spark Marathon
- Spark Midas
- PLATINblue AS-1



**Note:** For AS 6.1L, AS 3950 and AS-1 exist different firmware versions which do not support all of the described features.

AS 6.1L: Firmware 1.18 supports the 30 vials tray and 2500 µl syringe also outside of the Prep mode. The advanced wash functionality also requires firmware 1.18.

AS 3950: The 84+3 vials tray for advanced µl pick-up is supported from firmware 1.04. Firmware 1.15 comes with the support of 0.1 µl increments and allows the a tray thermostating from 4 to 40 oC. The 108 vial tray is supported from firmware 1.16. Firmware 1.18 supports the 30 vials tray and 2500 µl syringe also outside of the Prep mode. AS-1: With firmware 1.02 the tray thermostating from 4 to 40°C is supported.



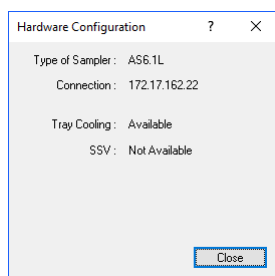
**Note:** In order to access an autosampler of the models 3800, 3900, or KNAUER Optimas, the autosampler has to be set to *SERIAL MODE*.

Refer to chapter Configuration - autosamplers for corresponding instructions.

Except for the column oven, the features of the KNAUER Optimas autosampler correspond to the AS 3900/Midas. The KNAUER Optimas is not equipped with a column oven.

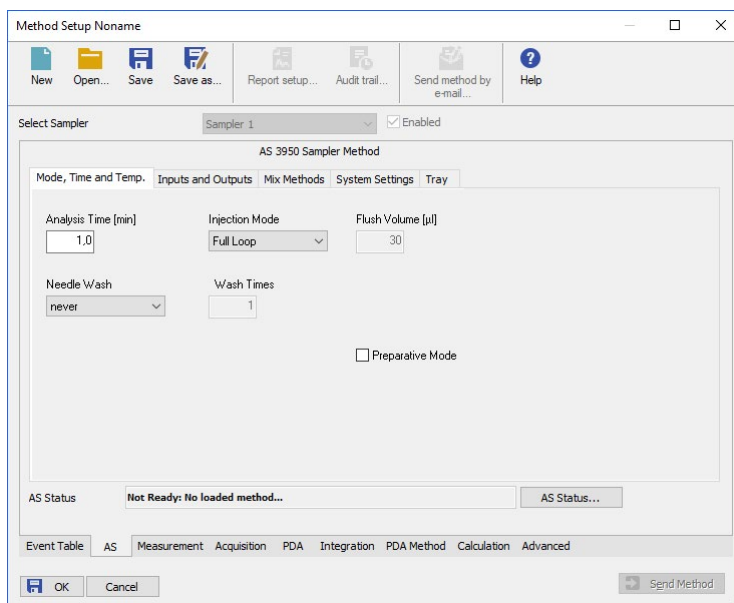
The autosampler method window (AS) includes several different tabs as described below and a tab independent button AS Status.

*AS STATUS*: *AS STATUS* reads out and displays a status summary.

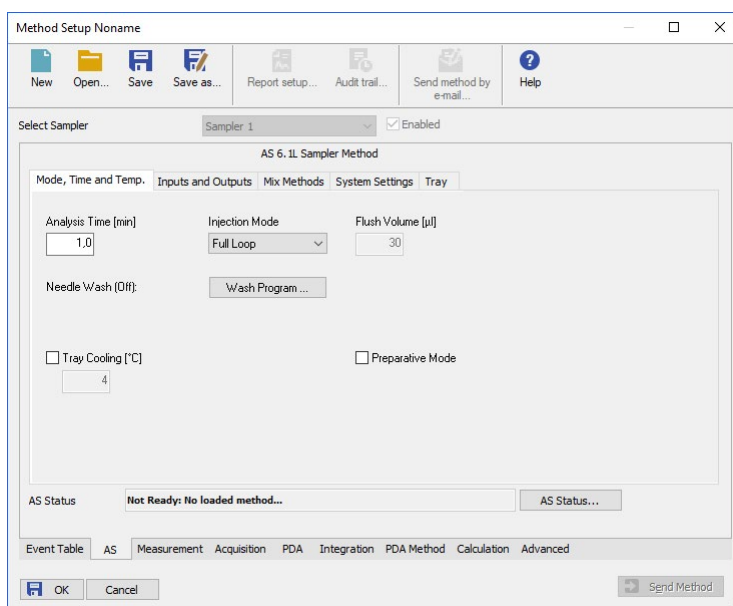


**Fig. 115:** Autosampler status

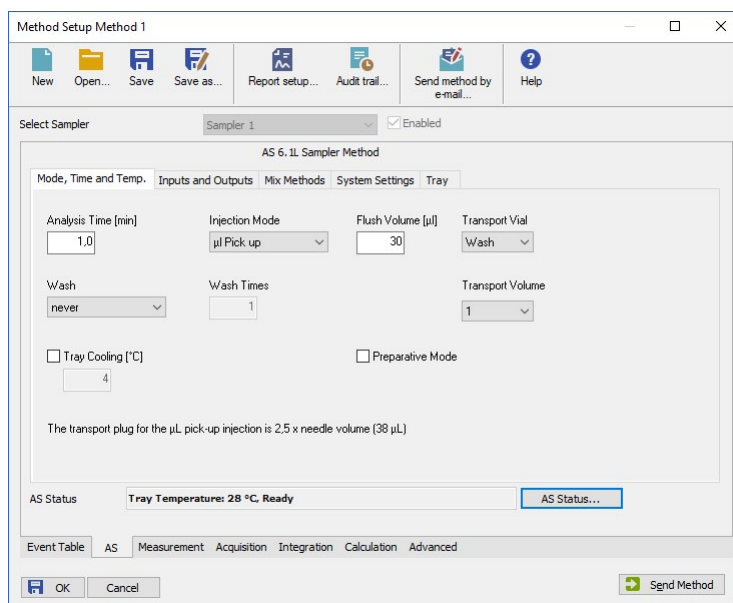
## 8.1.1 Mode, time and temperature



**Fig. 116:** Autosampler AS 3950, mode, time and temperature



**Fig. 117:** Autosampler AS 6.1L, mode, time and temperature



**Fig. 118:** Autosampler AS 6.1L,, mode, time, temperature, µl pick-up, tray "84+3 vials"

**ANALYSIS TIME [min]:** Sets the run time for the autosampler. The time should not exceed the measurement time; otherwise the system will wait for the next run until the autosampler is ready. Due to different controls, the recommended analysis time for the autosamplers AS 6.1L, AS 3950 and AS-1 is 0.1 minute, for all other autosamplers same as the run time, set in Measurement tab.

In addition, the direct control functionalities of the device monitor, e.g. extruding the tray to apply samples, are only available after *ANALYSIS TIME* has been finished.


Extended Wash will also start after *ANALYSIS TIME* has been finished. Therefore, *ANALYSIS TIME* should be as short as possible to prevent prolonged waiting times.

**INJECTION MODE:** Select the mode of injection from the drop-down list. The options are: *NONE*, *PARTIAL LOOPFILL*, *FULL LOOP*, and *µL PICK UP*. Refer the autosampler manual for detailed information about the injection mode. Choosing the best injection mode is especially delicate with regards to the injection volume and the volume of used-up sample.



**Note:** For the AS 6.1L / AS 3950, no transport vial can be selected for the injection method *µL PICK UP* except for the tray type „84+3 vials“. The transport liquid for the *µL Pick up* will be escaped from the transport bottle or the wash bottle.



**Note:** If the „84+3 vial“ tray is selected, a transport vial (vials 85-87) can be selected for the transport liquid. When the autosampler is switched on, the filling level of the transport vial is automatically set to full (8000 µl). It can be set to full by clicking  in the device monitor.

**FLUSH VOLUME:** *FLUSH VOLUME* defines the sample volume which the injection system (needle and tubing between needle and injection valve) is flushed with prior to drawing the actual injection volume. The option *FLUSH VOLUME* is not available for the injection methods *NONE* or *µL PICK UP*.

**TRANSPORT VIAL** (for tray 84+3 vials with *µL PICK-UP* only): The tray „84+3 vials“ includes 3 additional vials with max. 10 ml volume, that can be used as transport vials for the injection method *µL PICK UP*.

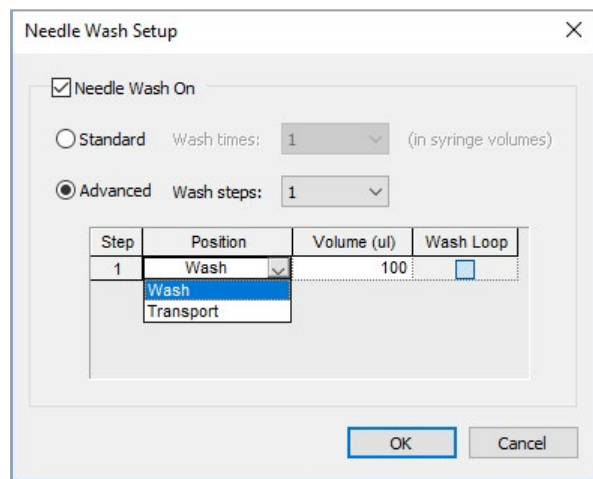
For each injection with injection method  $\mu\text{l}$  *PICK UP*, the autosampler draws one segment of transport liquid before and after the sample volume, the so-called transport plug. The transport plug is 2.5 times the so-called needle volume. The needle volume is identical to the tubing volume, see tab *SYSTEM SETTINGS* in the autosampler setup. The tubing volume is noted on a label on the tube installed between the injection needle and the injection valve. The default tubing volume is 15  $\mu\text{l}$ . The filling level of the transport vials will be set to 8000  $\mu\text{l}$  each time the autosampler will be switched on.

The autosampler calculates then the current filling level after each run. Please be sure to fill the transport vials completely, because the autosampler also calculates the needle immersion depth, basing on the filling level, between two different heights. If the autosampler calculates, that the transport vial is empty, the injection and therewith the sequence will be stopped. In a method you can only set one transport vial. If you need more than one transport vial in a sequence, you must create additional methods with the desired transport vial.

*TRANSPORT VOLUME* (for  $\mu\text{l}$  *PICK UP* with standard trays): If *WASH* as transport vial is selected, wash solution will be used to flush the needle and transport the aspired sample into the sample loop.

To flush the injection system with wash solution first, under *TRANSPORT VOLUME* the number of syringe volumes used to flush can be defined. The needle port that is used to aspire the transport solution has a volume of about 200  $\mu\text{l}$ . In case a 250  $\mu\text{l}$  syringe is installed and the volume of the tube between syringe and injection valve has also a volume of 250  $\mu\text{l}$ , in minimum value of 3 should be selected for the Transport Volume.

*NEEDLE WASH*: Click on the button *WASH PROGRAM...* To use a wash program check the dialog box *NEEDLE WASH ON*. Two different wash modes are available:



**Fig. 119: Advanced needle wash setup**

*STANDARD*: Check standard, to use one solvent to wash the needle after an injection. Choose the number of wash cycles by selecting the corresponding value within the dropdown menu *WASH TIMES*. The value is indicated as syringe volume

*ADVANCED*: The advanced mode will allow to use two different solvents. Select how many different wash steps should be carried out. Up to 9 different wash stops could be selected. Choose in every step, if the wash or transport solution should be used. Choose the volume in  $\mu\text{l}$  to use during each step. Please keep in mind that the tubings need to be flushed as well. Choose a volume greater than the volume of the tubing connected the syringe valve and the injection valve. The

option *WASH LOOP* will divide the chosen volume into two equally large segments, whereas the second segment will be used to flush the the sample loop.

If a 84+3 vial tray is used, advance wash will use the wash/transport bottles, but not the vials.



**Note:** Advanced wash is available for AS 6.1L only.

*WASH:* The options for injection needle wash are *NEVER*, *BETWEEN INJECTIONS*, and *BETWEEN VIALS* (only if the next injection comes from a different vial).

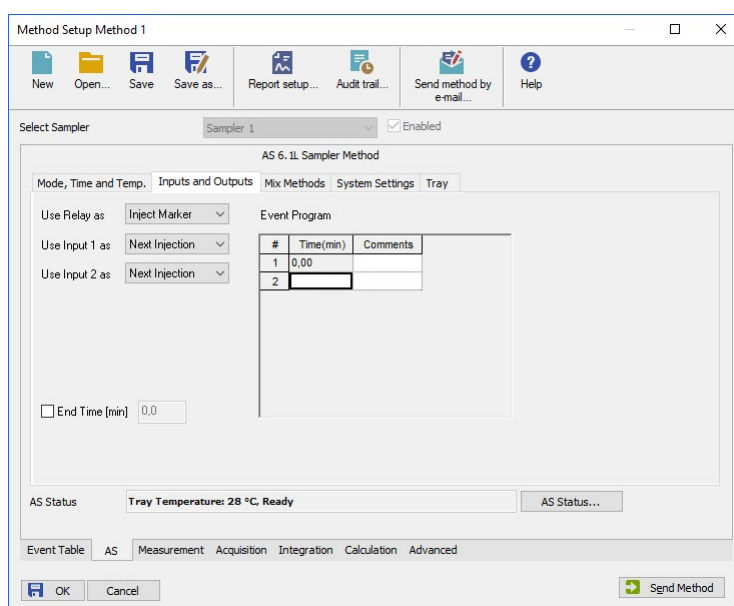
*WASH TIMES:* Select how often the needle should be flushed. 1-9 times is possible.

*TRAY COOLING [°C]:* The temperature can only be set if the option field is checked. Tray cooling is optional.

*PREPARATIVE MODE:* If the autosampler is a preparative model, you can activate the check box *PREPARATIVE MODE*. The preparative mode allows for larger injection volumes. If this option is enabled, the injection loop volume and the syringe volume, available in the system settings tab, have been set to fixed values (loop: 10 ml, syringe: 2.5 ml). In Prep mode only the *INJECTION MODE PARTIAL LOOPFILL* is available.

## 8.1.2 Inputs and outputs

The inputs and outputs, available via the separate connector *I/O* in the autosamplers rear panel, are not required to control the autosampler by software.



**Fig. 120:** Autosampler, Inputs and Outputs

*USE RELAY AS:* Select *INJECT MARKER*, *AUXILIARY* or *ALARM* from the drop-down list. If *AUXILIARY* is selected, the event program table is extended by a corresponding column.

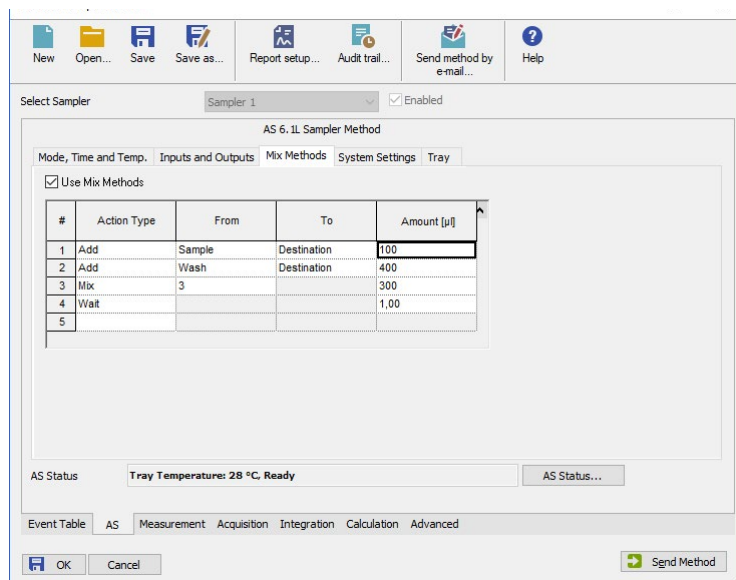
*USE INPUT 1 or 2 AS:* Select *NEXT INJECTION*, *FREEZE*, *STOP* from the drop-down list for both inputs separately.

*USE SSV:* If this option field is checked, the event program table is extended by the SSV column.

**END TIME [min]:** If this option field is checked, you can define a time interval (may be different compare to Analysis Time) at which the time base methods will be active.

**EVENT PROGRAM:** Enter the time program for *SSV* and *AUXILIARY* (if selected) relays.

### 8.1.3 Mix methods



**Fig. 121: Autosampler, MIX METHODS**



**Note:** *MIX METHODS* only work correctly for sequence runs. Using it with a single analysis, the destination vial positioning will not work correctly. No error message will appear.

Mix methods that use vials for destination, reagent A and reagent B can only be programmed if the appropriate vials have been defined in the *TRAY* setup.

**USE MIX METHODS:** Check the *USE MIX METHODS* option to get access to the fields of this window. Select a new action type from the drop-down list to start a line, the choices are *ADD*, *MIX* and *WAIT*.

#### Action Type Add

#	Action Type	From	To	Amount [µl]
1	Add	Sample	Sample	0
2		Sample	Sample	
		Reagent A	Destination	
		Reagent B		
		Wash		

**Fig. 122: Autosampler, mixing step add**

**ACTION TYPE:** If *ADD* is selected, specify the *AMOUNT* of a liquid in µl (max = the syringe volume) to be aspirated from a source (choices are *SAMPLE*, *REAGENT A*, *REAGENT B*, or *WASH*) and dispensed to a target (choices are *SAMPLE* or *DESTINATION*). The aspirate and dispense speed depends on the selected syringe and syringe speed (*SYSTEM SETTINGS* · *SYRINGE SPEED*).

The vial positions for the reagents and the destination vial you must define first in the *TRAY* setup. For reagent A and reagent B one vial position can be selected. Make sure, that the reagent volume is sufficient for a complete injection series.

As a destination for each sample one destination vial will be used. You can only define the first destination vial.

#	Action Type	Repeat	...	Amount [µl]
1	Mix	1		0
2		3		
		4		
		5		
		6		
		7		
		8		
		9		

**Fig. 123:** Autosampler, mixing step mix

According to the number of mixes (Mix *TIMES* 1-9), the set amount (*AMOUNT* µl, maximum is the syringe volume) is collected and returned. If no destination vial is used the mixing step is performed in the sample vial.

**Action  
Type Wait**

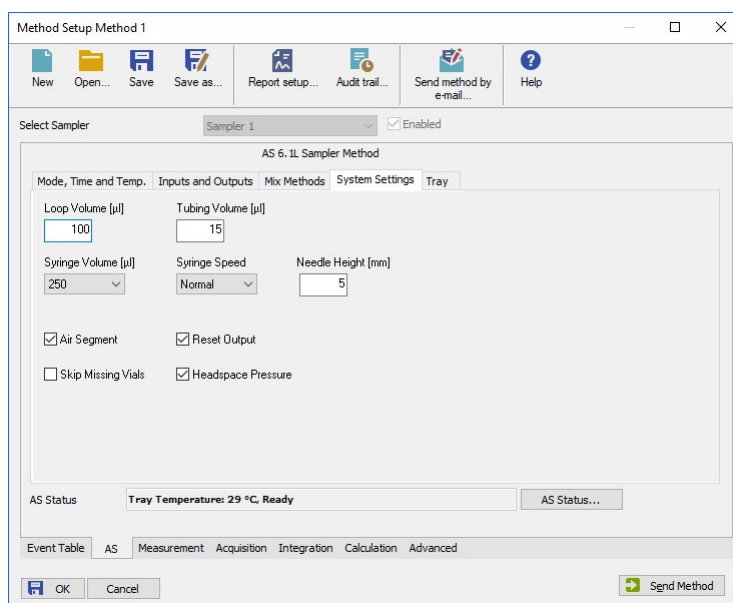
#	Action Type	...	...	Time [min]
1	Wait			1,00
2				

**Fig. 124:** Autosampler, mixing step wait

If the action type *WAIT* has been selected, you can enter the amount of time (in minutes) during which the autosampler should pause before it starts the next step of the program or the injection.

If the complete Mix method was executed, as the next step the injection will be made. The injection method is defined in the method; the injection volume will be defined in the sequence. If you use a destination vial, the injection will always be made from the destination vial and not from the sample vial.

## 8.1.4 System settings



**Fig. 125:** Autosampler, system settings



*LOOP VOLUME* [ $\mu\text{l}$ ]: Enter the volume of the installed sample loop. If the *MODE, TIME AND TEMP.* tab of the *PREPARATIVE MODE* is activated, the loop size is set to 10000  $\mu\text{l}$  unchangeably.

*TUBING VOLUME* [ $\mu\text{l}$ ]: Enter the volume of the installed needle and tubing in  $\mu\text{l}$  as labeled on the tube. The default settings are 15  $\mu\text{l}$  and for the preparative mode 45  $\mu\text{l}$ . If the enclosed connection tubing is used, you will find a label on it which states the volume.

*SYRINGE VOLUME*: Accessible depending on the configured autosampler. The default syringe size was changed from 500  $\mu\text{l}$  to 250  $\mu\text{l}$ . While former autosamplers 3950 were equipped with a 500  $\mu\text{l}$  syringe, the later devices have a 250  $\mu\text{l}$  syringe. Select the volume of the installed syringe from the drop-down list. The options are 250  $\mu\text{l}$ , 500  $\mu\text{l}$ , 1000  $\mu\text{l}$  and 2500  $\mu\text{l}$ . The syringe volume 250  $\mu\text{l}$  is supported as of firmware version 1.15, 2500  $\mu\text{l}$  from firmware 1.18 (also if no preparative mode is selected). The syringe volume of 1000  $\mu\text{l}$  is not supported at the moment. The autosamplers 3950 with older firmware can only be run with a 500- $\mu\text{l}$  syringe. If the *PREPARATIVE MODE* is set, the syringe size is set to 2500  $\mu\text{l}$  unchangeably.

*SYRINGE SPEED*: Select the syringe speed from the drop-down list. The options are *LOW, NORMAL,* and *HIGH.*

*NEEDLE HEIGHT*: Enter the distance between the needle top and the tray holder (plate holder). A distance of 5 mm is preset. A distance between 2 and 6 mm can be selected. If you use inlets with your valves, please not to adjust the needle height accordingly. The lowest height is 2 mm, and consequently the lowest point to which the needle can be immersed in the vial.

*AIR SEGMENT*: Check the air segment box to enable the use of an air segment between the sample and the wash solvent to reduce the amount of flush volume.

*RESET OUTPUT*: Check this option if the outputs should be reset to the default settings after finishing the last series.

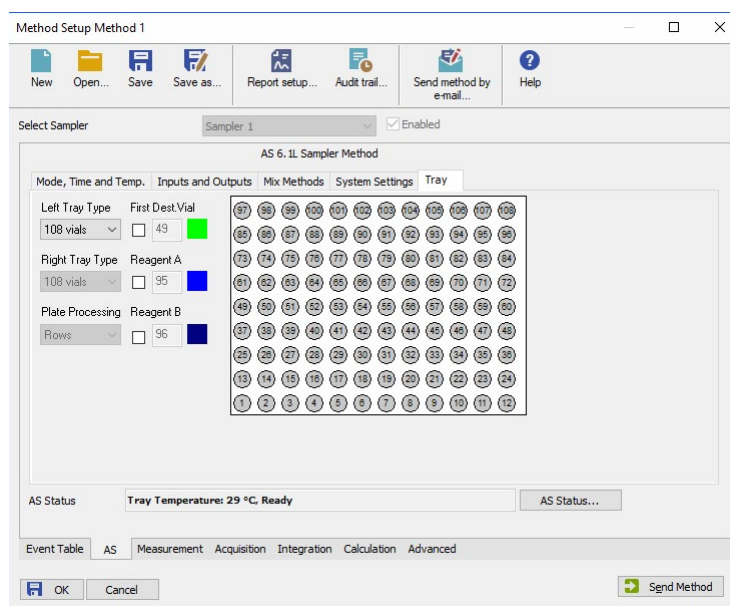
*SKIP MISSING VIALS*: Activate if the autosampler shall not stop if a vial is not found but continue with the next programmed vial. Deactivate to stop the autosampler in case a vial is not found.

*HEAD SPACE PRESSURE*: Activate the *HEAD SPACE PRESSURE* option to support the sample transport to the sample loop by clicking. This prevents any negative pressure, that might occur in the vial when the sample is aspirated, from influencing the injection volume. The compressor will always be used during a wash procedure.



**Note:** The accuracy and reproducibility of the autosampler may decrease if head-space pressure is switched off.

## 8.1.5 Tray



**Fig. 126:** Autosampler, tray view

The appearance of the *TRAY* tab depends on the configured autosampler. Here the AS 6.1L is described as an example.

*LEFT (RIGHT) TRAY TYPE:* Select the tray type from the drop-down list. The options are *12 VIALS*, *30 VIALS*, *48 VIALS*, *108 VIALS*, *96-HIGH*, *96-LOW*, *384-LOW*, and *84+3 VIALS*. The additions *HIGH* and *LOW* indicate the height of the well plates. Principally it is possible to select different tray types for the left and right side. Only the variant *384-LOW* left and *96-HIGH* right is not possible. If the preparative mode is activated, only trays *12 VIALS* or *30 VIALS* are selectable.

If the preparative mode is activated, the tray type *12 VIALS* is fixed for both sides. If the tray *84+3 VIALS* is selected, it is valid for both sides because it takes up the whole width of the device. For the autosampler 3950 the tray *84+3 VIALS* is supported from firmware version 1.14, the tray *108 VIALS* from firmware version 1.16 and for AS 3950 and AS 6.1L the tray *30 VIALS* from firmware version 1.18.

*PLATE PROCESSING:* Select the order of vial processing from the drop-down list. The choices are *Columns* and *Rows*.

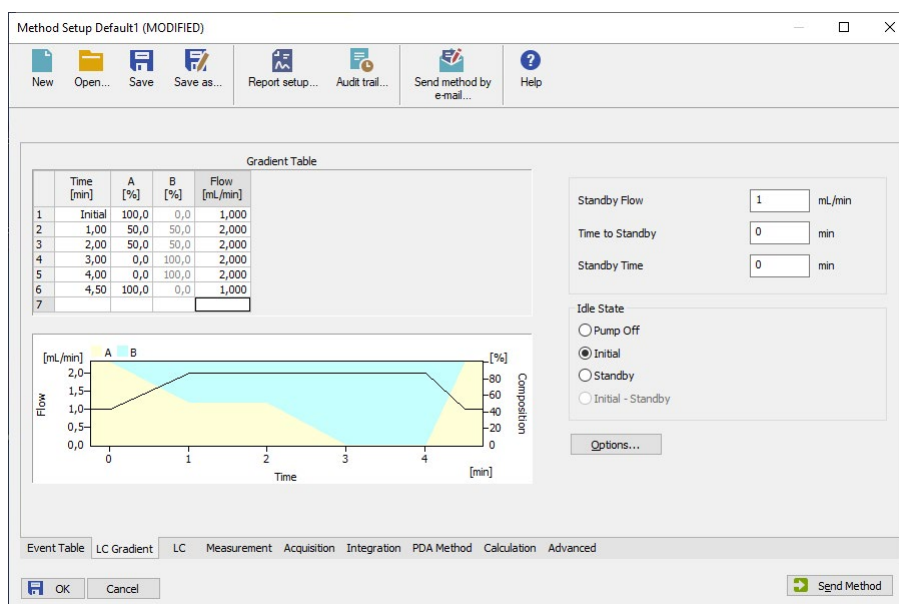
*FIRST DEST. VIAL:* Enter the position number of the first destination vial. The selected number will be green highlighted. A destination vial is required, if a mixing should be done in a separate vial. One destination vial is required for every sample, however, only the first destination vial position can be specified.

If more than one destination vial is required, these will follow automatically from the first destination vial position. Therefore sample and destination vials are both defined as blocks, for instance, sample vial positions 1-10, destination vial positions 11-20.

*REAGENT A (B):* Enter the position numbers of the reagent vials A and B. The selected number will be highlighted blue. For the tray *84+3 VIALS* additional vials 85-87 can be used as reagent vials. If the injection method *ML PICK UP* is selected and one of the additional vials is selected as a transport vial, the reagent vial selection for this vial will be ignored.

The accuracy and reproducibility of the autosampler may decrease if headspace pressure is switched off.

## 8.2 LC Gradient



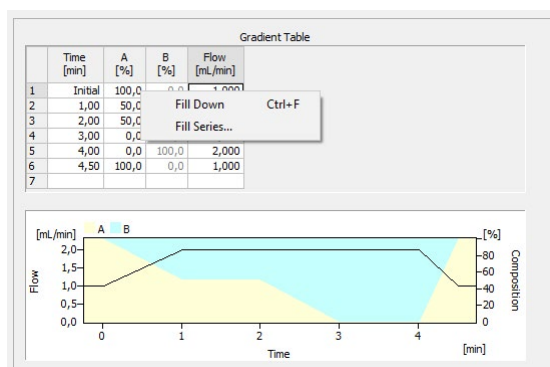
**Fig. 127: LC Gradient setup**

In the menu *LC GRADIENT*, you can set the parameters for the solvent pump(s). You will find the possible settings for the Solvent Factor, the p-max mode and the Solvent Selection Valves of the pump P 6.1L as well as the settings of the auxiliary pump in the tab LC.

*GRADIENT TABLE*: The gradient table is shaped according the performed pump configuration. Entering the gradient time program it is simultaneously displayed with a black line for the total flow and colored areas for the gradient composition.

In the gradient table, the time program is entered. In the first row (at time Initial = 0.00 min), enter the initial flow and composition in ml and % respectively. Additional lines can be used to enter different values for flow and composition, which can be set for any time (in minutes). The minimal distance between two lines is 0.02 minutes, or 0.06 minutes for the pumps P 2.1L and 1800.

All time programs are displayed in a spreadsheet similar to the one shown below. Although the information in the fields will vary, the spreadsheets always support certain basic features.



**Fig. 128: Editing tools for the time program**

Each row is assigned a program line number and time in minutes, followed by columns for information for each time in the program. Rows and field information can be cut, copied, pasted, and cleared. To open the menu with these commands, right-click anywhere within the spreadsheet. To select a field, click on that field to highlight.

To select a row, click on a number in the # column to highlight the entire row. To select the entire spreadsheet, use the right-click menu, and click the option *SELECT ALL*.

Certain spreadsheet fields will have choices available for you to select. Fields with selections available will display a drop-down arrow is displayed and an action can be selected.

### Selection menu

*CUT*: This command will cut the current selection and place it into the clipboard. You can subsequently paste the information to another application using the *PASTE* command.

*COPY*: Use this command to make an exact copy of the selection in the clipboard. Once you select *COPY*, you can paste the selection to another application, or copy the selection to a location in your spreadsheet.

*PASTE*: This command is used to paste the information currently in the clipboard into the spreadsheet at the location of the cursor.

*FILL DOWN*: This enables you to automatically copy spreadsheet information from one field or row down through the rest of the spreadsheet.

*FILL SERIES*: This enables you to automatically copy spreadsheet information from one field or row down through the rest of the spreadsheet. An increment may be used to modify the content.

*INSERT LINE*: This command inserts a copy of the line in the spreadsheet below where the cursor is located.

*DELETE LINE*: This command deletes the line in the spreadsheet where the cursor is located.

*DELETE LINES*: This command deletes the selected lines in the spreadsheet.

*CLEAR*: Like the *DEL*. (Delete) key of your keyboard, this command deletes the content of all selected fields.

*CLEAR ALL*: Use this command to clear the information from the entire spreadsheet.

*SELECT ALL*: Use this command to select the entire spreadsheet.

### LC Gradient Standby Settings

If a time is entered for *TIME TO STANDBY* and/or *STANDBY TIME*, the standby is added to each run. If standby is finished, the parameters which are defined in *IDLE STATE* are executed.

*STANDBY FLOW* [ml/min]: Enter the desired standby flow for your pump. For a gradient system the standby will always run with the settings of the initial line of the pump program.

*TIME TO STANDBY* [min]: Enter the after run time for changing your pump delivery to the set standby flow. Changing the parameters at the end of a run until a defined point of time (time to standby) is executed as a linear gradient (flow and gradient composition).

*STANDBY TIME* [min]: Enter the time for the Standby flow. When this time has elapsed, the pump will switch to the conditions defined in the idle state.

The described standby on the *LC GRADIENT* tab does not affect the standby function of some newer KNAUER devices. ClarityChrom®/Prep does not support this advanced device feature.

*IDLE STATE*: The *IDLE* status defines the pump status at the end of each run. This is also valid for each run inside a sequence. Choose between the options *PUMP OFF*, *INITIAL*, or *STANDBY*. If *INITIAL* is selected, the pump runs under the start conditions (time line Initial) of the current method. The *STANDBY* status is described above. Please note that the *IDLE* state is also executed for a short time if a sequence is running and before the next run on a sequence table is initialized.

### Options...

**Fig. 129:** LC Gradient setup, options

*MIN. PRESSURE*: Enter the minimum pressure allowable for your pump. The pump will be stopped when pressure drops for more than one minute the set value. Setting 0 deactivates this functionality.

*MAX. PRESSURE*: Enter the maximum pressure you want allow for the system. The pump will be stopped immediately when pressure increases the set value. The default value always corresponds to the configured pump head. A setting above this value is not allowed.

*MAX. PRESSURE FOR SET FLOW*: This value will be use as the default maximum pressure at the set flow dialog of the LC monitor in the device monitor. To transfer this value, the method must send to the instrument.

*SOLVENT 1-4*: The configured solvent components can be named, activated and deactivated. Only activated components will be displayed in the gradient table and delivered during the run.

## 8.3 LC

The LC tab is visible if:

- the solvent type of the pump can be set or
- the pump is marked *AUXILIARY PUMP* during configuration.

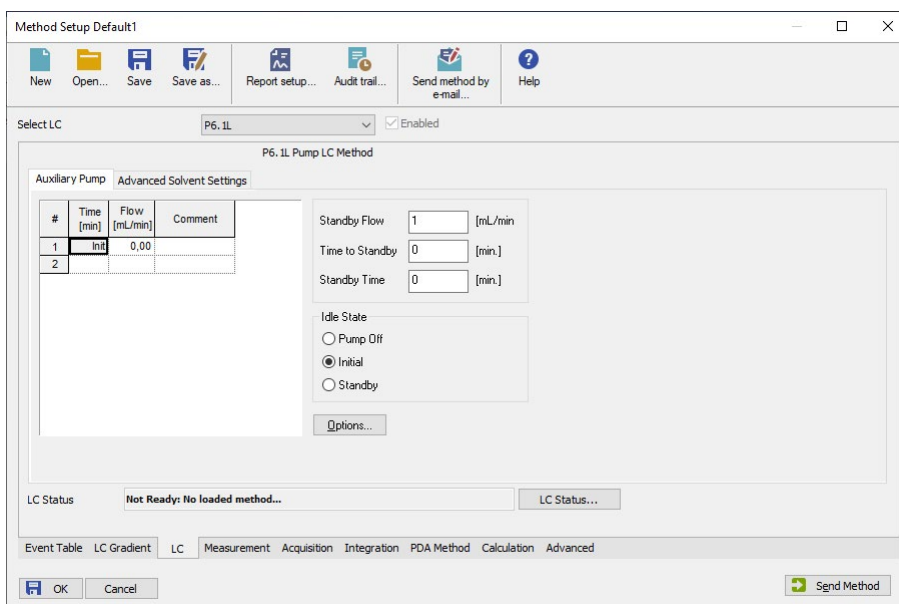


Fig. 130: LC auxiliary pump

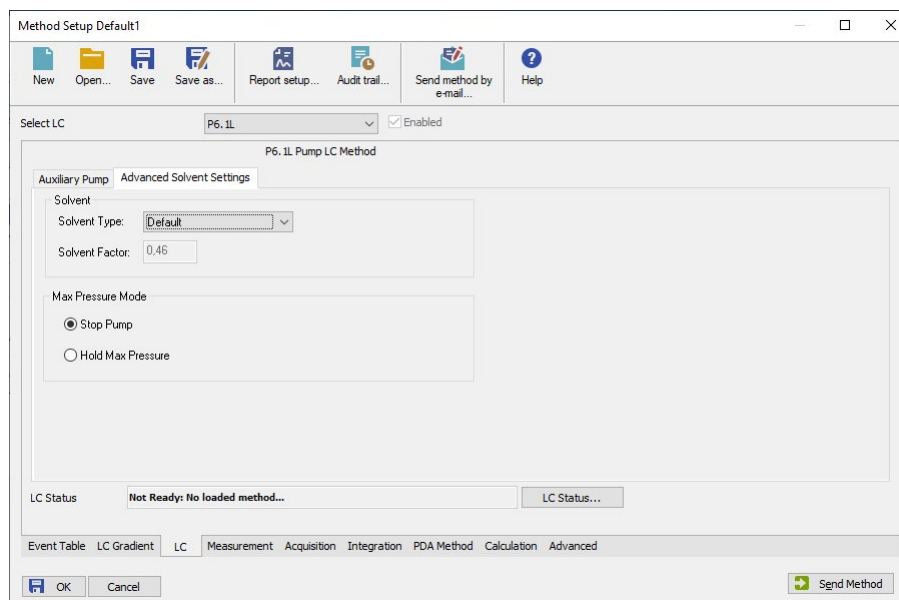
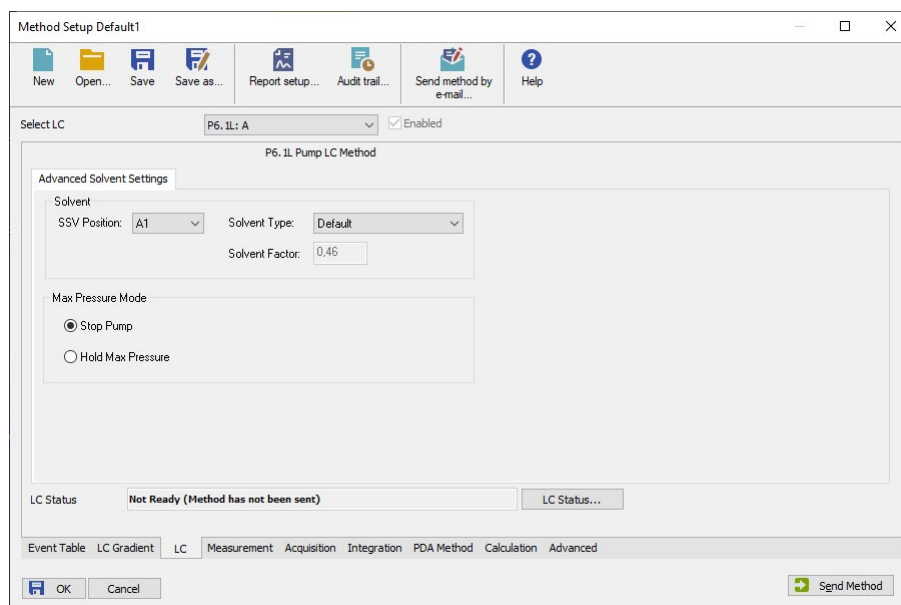


Fig. 131: LC advanced solvent settings P 6.1L HPG



**Fig. 132: LC advanced solvent settings**

*SELECT LC*: Selecting the pump for settings. The selection is only active after certain pump configurations have been made.

*ENABLED*: Enabled activates or deactivates the device. The device has to be switched on and connected.

**Advanced solvent settings** *SSV POSITION* (for P 6.1L HPG only): With SSVs (solvent selection valves), 2 solvents A1 and A2 can be selected for channel A, and 2 solvents B1 and B2 can be selected for channel B.

*SOLVENT TYPE*: Select the solvent from the drop-down list. A solvent factor is set with the selected solvents. The solvent factors includes the different compressibilities of solvents. Via the custom setting, a custom solvent factor (solvent factor compressibility) may be entered.

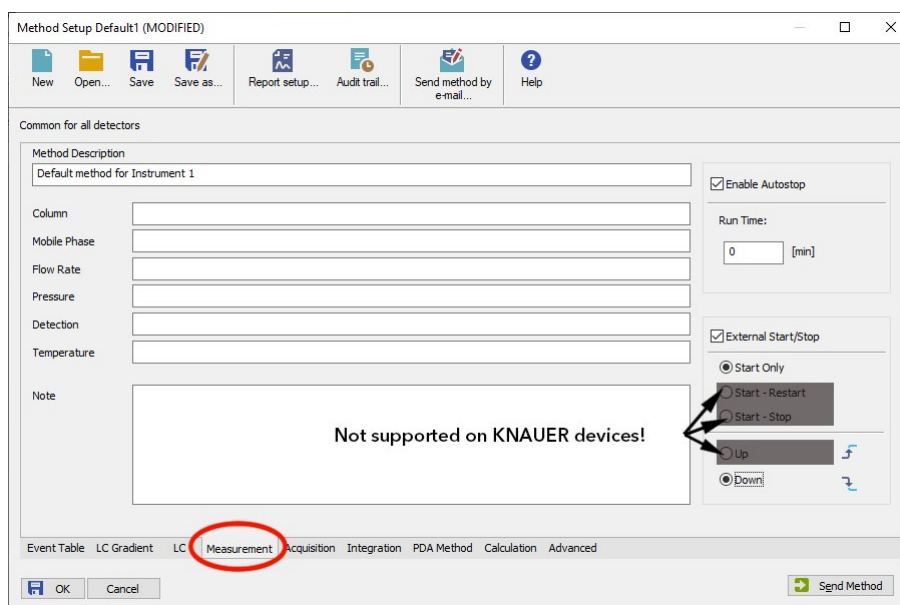
*SOLVENT FACTOR*: The solvent factor compressibility is entered automatically for the selected solvent. By selecting the solvent type *CUSTOM*, a customized solvent factor may be entered. This option is not available for all pumps.

*STOP PUMP, HOLD MAX PRESSURE* (P 6.1L only): Determines how the pump reacts when a set maximum pressure is reached. The options are *STOP PUMP* and *HOLD MAX PRESSURE*. *STOP PUMP* stops the pump immediately. With *HOLD MAX PRESSURE* the pump tries to hold a constant pressure of 90 % of the maximum pressure. All other pumps are switched off when the maximum pressure is reached.

*MIN/MAX FLOW (ML/MIN)*: Defines the minimum and maximum flow which is needed to execute the Hold Max Pressure functionality.

**Auxiliary Pump** The *AUXILIARY PUMP* tab is only displayed when the pump has been configured as an auxiliary pump. The setting possibilities correspond to the settings for the solvent pumps. Please refer to the chapter „LC Gradient“ on page 102 for settings.

## 8.4 Measurement



**Fig. 133: Measurement**

This window describes measuring conditions that includes determining the duration an analysis should take place. By clicking *METHOD SETUP · MEASUREMENT*, the dialog is opened. This tab is common for all signals when a multi-detector chromatogram is in use.

*METHOD DESCRIPTION*: Contains the description of the method. Upon selection of a method the description of the method will be displayed in the description field.

*COLUMN*: Describes the column being used (for informational purposes only).

*MOBILE PHASE*: Describes (for informational purposes only) the mobile phase used.

*FLOW RATE*: Indicates (for informational purposes only) the mobile phase flow rate.

*PRESSURE*: Indicates (for informational purposes only) the mobile phase pressure.

*DETECTION*: Contains detector characteristics (for informational purposes only).

*TEMPERATURE*: Describes temperature parameters (for informational purposes only).

*ENABLE AUTO STOP*: Sets the system to automatic stop of a run after the elapsed run time. If this option is not activated, the run can only be stopped manually.

*RUN TIME*: Specifies the duration of analysis. After the appointed run time has been reached, the analysis is automatically terminated and processed. The possible interval is between 0.2 - 999 minutes.



**Note:** A run time must be set for all methods used in an active sequence since the time determines the cycle duration.



**Note:** If more than one detector is used, the settings are valid for all detectors.





**Note:** After longer runs with a high data rate and a broad 3D spectrum, for the PDA detectors may encounter problems with storing the 3D data may encounter. During this process, the computer does not react on user input or only with a delay. The next run will only be started, if the data of the previous run are stored. In order to prevent this, runs with a 50 or 100 Hz data rate should be limited to a maximum run time of 10 min.

*EXTERNAL START/STOP:* Enables control via external signals, e.g. a start/trigger signal of an injection valve or autosampler. This setting is mandatory for starting a sequence. Which device receives the start/trigger signal has been set during configuration.

*START ONLY:* The external signal only starts analysis.

*START - RESTART:* The external signal terminates the analysis in progress and at the same time starts a new one. This is known as "the continuous measurement".

*START - STOP:* The external signal starts and stops an analysis. The first signal start the analysis, the second signal stops it, etc.

*UP:* The system reacts to a voltage change in the relevant controlling input from low (< 0.7 V) to high (> 3V), or in other words, to a closed contact. This function is not supported by KNAUER instruments.

*DOWN:* The system reacts to a voltage change in the relevant controlling input from low (< 3V) to high (> 0.7 V), or, in other words, to a closed contact.

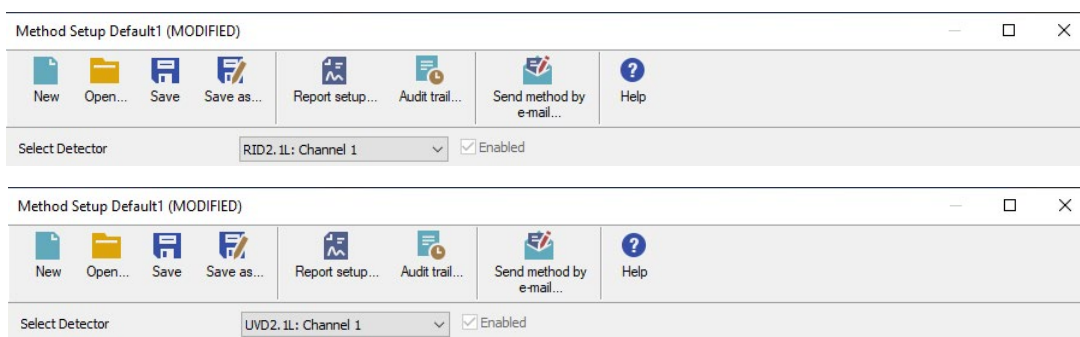


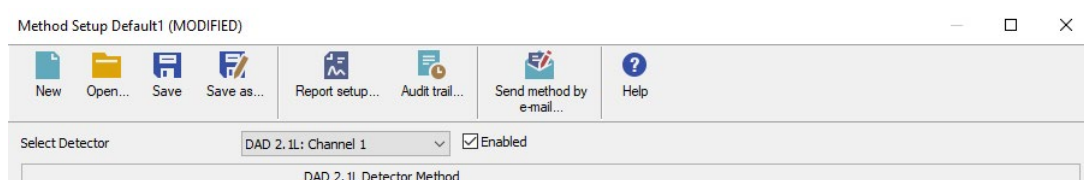
**Note:** KNAUER devices do not support the features *START - RESTART*, *START - STOP*, and *UP OR DOWN* and *DOWN*. Only use the options *START ONLY* and *DOWN*!

## 8.5 Acquisition, Detector Method

In addition to the *FROM DET* and *DET* statuses, the *METHOD SETUP / ACQUISITION* window contains one or more tabs which are explained below.

*SELECT DETECTOR:* *SELECT DETECTOR* cannot be accessed if only one detector is included and this detector works with only one channel. If more than one detector or a detector with more than one channel is configured, the selector becomes accessible and each detector or channel can be enabled or disabled using the. At least one detector (channel) has to remain enabled; therefore you cannot disable the last one.





**Fig. 134:** Acquisition, detector setup selector



**Note:** Even if the detector has been deactivated via *SELECTOR DETECTOR - ENABLED*, it has to be switched on, connected and ready for measurement. It is not possible to start a run if the deactivated detector has switched off the lamp.

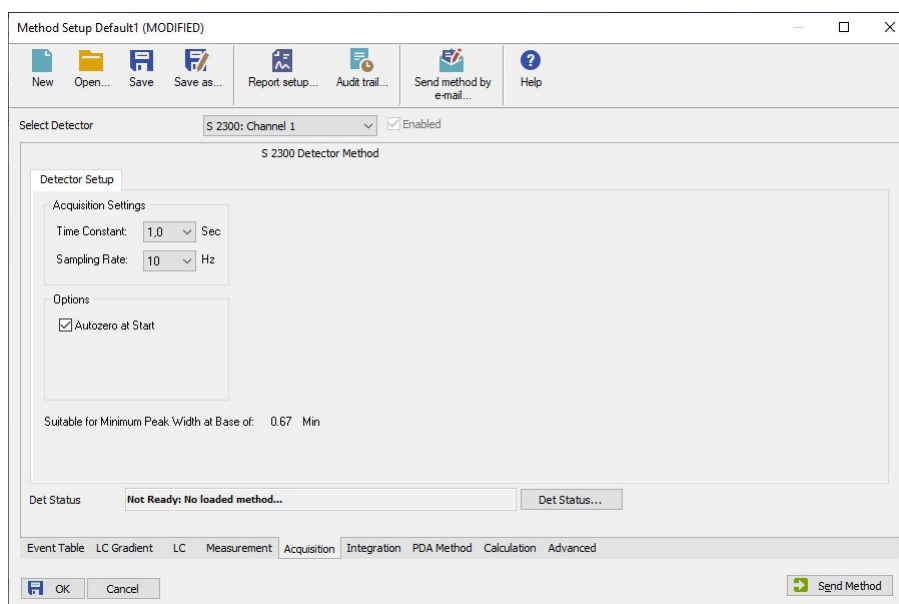


Any involved detector needs its own setup. In case of multi-channel detectors the channel setup tab is only valid for the selected channel. Settings made under *ACQUISITION SETTINGS*, *OPTIONS*, and *ANALOG OUTPUT ON* are independent of any channels and are valid for the detector as a whole.

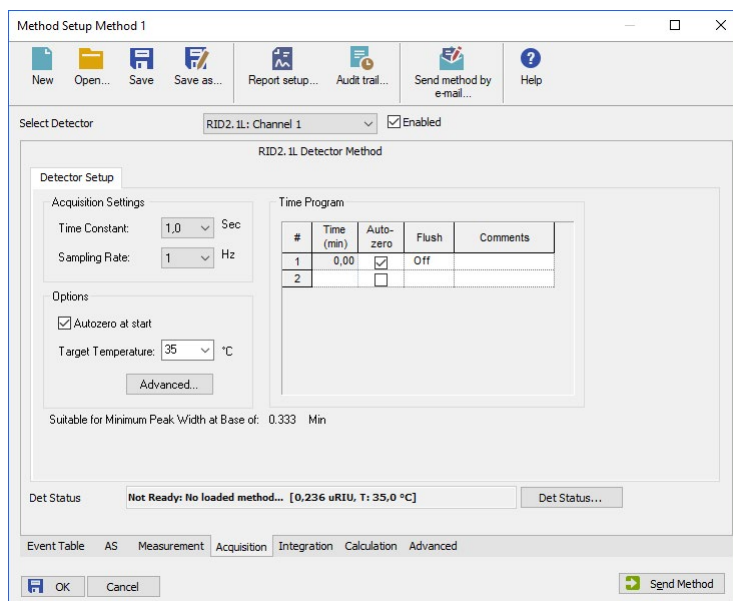
Detectors that have been deactivated via the field *SELECT DETECTOR* cannot be used to control the fraction collection. Select the channel for the fraction collection in the setup of the fraction collector.

The *DET STATUS* reads out and displays a status summary.

## 8.5.1 Acquisition, RI Detector Method



**Fig. 135:** Acquisition, RI detector setup



**Fig. 136: Method setup RID 2.1L**

**TIME CONSTANT:** Select the time constant from the drop-down list. The time constant is a smoothing functionality and should be selected in accordance with the needed data rate. The larger the value of the selected time constant, the stronger the applied signal smoothing. This reduces the noise but also the signal level.

The options are *0.01*, *0.02* AND *0.05 SEC* for detectors with a maximum data acquisition rate of 10 Hz. A good rule is to select a time constant, which is at least one tenth of the peak width at the base of the narrowest peak of interest. The relation between the selected sampling rate and its suitability for minimum peak width is displayed below in the setup window. For detectors with data rate up to 100 Hz, additionally time constants of *0,01*; *0,02* and *0,05 SEC* are available.

**SAMPLING RATE:** This is the rate at which data will be sampled by the system. The **SAMPLING RATE** is displayed in Hz (data points per second, i.e. data rate). Select it from the drop-down list. The options are *1*, *2*, *5*, and *10* Hz. For a reproducible integration of a peak, a minimum of 20 data points (better would be 30-40 points) is required.

The relation between the selected sampling rate and its suitability for minimum peak width is displayed below in the setup window. For RID 2.1L additionally *20*, *50* and *100* Hz are selectable.



**Note:** It is recommended that you use the peak width's (see Graphical Events Programming or if included peak report) to determine the optimal sampling rate for your chromatography. Consequently, at a data rate of 1 Hz the peak should be at least 20 seconds wide. If in doubt about the peak width, choose a higher data rate.

**AUTOZERO AT START:** Check this option to perform an autozero, i.e. to start the run with a value of 0. Otherwise, the current signal will be defined as the starting point.

**TARGET TEMPERATURE:** The temperature for the measuring cell can be selected. A value between 30 and 55 °C can be selected. If *OFF* is selected, the heating unit is switched off. Keep in mind, that reaching the target temperature needs some time.

Heating up the cell temperature from room temperature to 35 °C may need 30 minutes; cooling down a longer time.



**Note:** The cell temperature can reach only up to a flow rate of 4 ml/min. If using higher flow rates, the eluents must be pre-temperated.

**Time Program** *TIME PROGRAM:* In the time program autozero and flush for the detector can be programmed. Flush during a data acquisition is only recommended, if the solvent or solvent composition is significantly changed. Be sure that during flush no analyte is passing the detector.

### Advanced

**Fig. 137:** RID 2.1L, *ADVANCED* button

#### *EQUILIBRATION SETTINGS:*

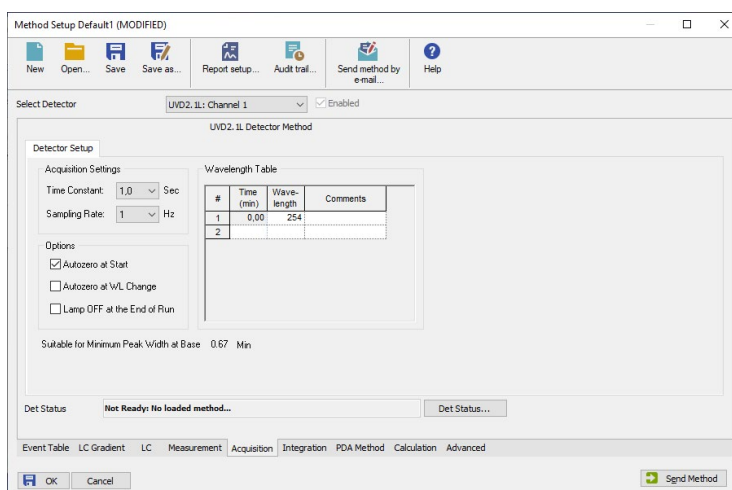
*WAIT BEFORE INJECTION:* The settings *WAIT WITH TOLERANCE* allow the autosampler to wait for an injection until the start temperature set in the temperature program is reached. Prior to every injection, the autosampler will wait until the start temperature is reached and the *WAIT TIME* time has elapsed. During a single run, this setting has no effect, the run is started immediately, even if the set target temperature has not been reached yet.

*LED:* The LED power factor can be adjusted using the Light Intensity Factor setting in order to regulate detector sensitivity. Light source life time is also affected by changes to this parameter. By increasing or decreasing this factor, the total linear range of the device is decreased. The default setting is 1.

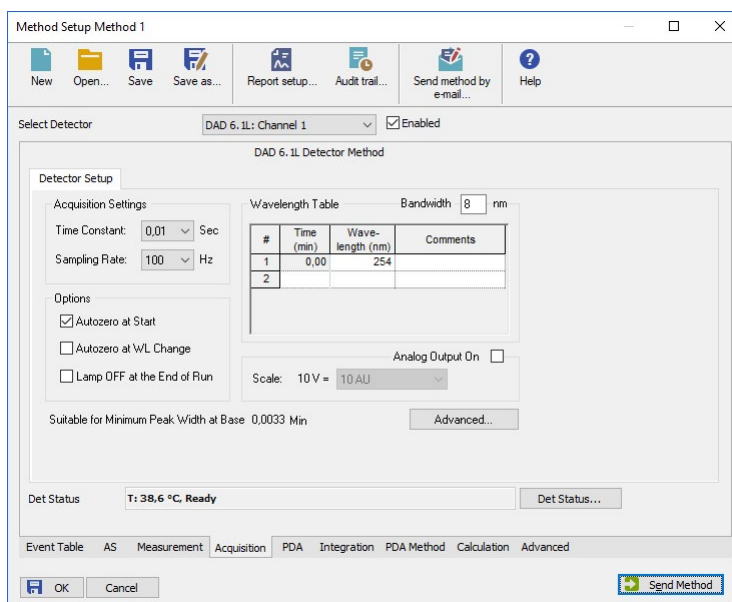
*EXTENDED RANGE:* The option Extended Dynamic Range grow-up the measuring range of the RID 2.1L and RID 2.1L HighFlow due to a zero position offset in positive or negative direction. The measuring range change is different for RID 2.1L and RID 2.1L HighFlow. You can find more details in the detector manual (document no. [V6750](#)).

*ANALOG OUTPUT:* If desired, the analog signal output can be used. The output scale can be set to 0.1, 0.5, 1, 2 or 5  $\mu$ RIU/mV. An output offset can be entered separately, e.g. to correct an offset of the A/D converter.

## 8.5.2 Acquisition, UV detector method



**Fig. 138:** Acquisition, UV Detector 2500 setup



**Fig. 139:** Acquisition, DAD 6.1L (DAD 2.1L, S 2600, PDA-1, 2800/2850 identical) setup

In case of multi-channel detectors (and also the DAD), the channel setup is only valid for the selected channel. The setup has to be made for all enabled channels separately. The channel-independent settings are entered in *ACQUISITION SETTINGS*, *OPTIONS*, and *ANALOG OUTPUT ON* and have to be made only once.

**TIME CONSTANT:** Select the time constant from the drop-down list. The time constant is a smoothing functionality and should be selected in accordance with the needed data rate. The larger the value of the selected time constant, the stronger the applied signal smoothing. This reduces the noise but also the signal level.

The selection depends on the selected detector. For detectors with an acquisition rate of up to 10 Hz, values between 0.1 and 10 sec can be selected. For detectors with a higher data acquisition rate (DAD 6.1L, DAD 2.1L, MWD 2.1L, PDA-1, UVD 2.1S, S 2520, S 2550), smaller values are possible (0.00, 0.01, 0.02, and 0.05 sec).

Smaller time constants are required for high speed analyses. A good rule is to select a time constant, which is the reciprocal of the selected sampling rate. The relation between the selected sampling rate and its suitability for minimum peak width is displayed below in the setup window.

*SAMPLING RATE:* This is the rate at which data will be sampled by the system. This selection is in Hz (data points per second). Select it from the drop-down list. The options are 1, 2, 5, and 10 Hz. If a detector model UVD 2.1L, S 2520 or S 2550 is connected via LAN and only one channel is enabled in the configuration (S 2550), also 20, 50, and 80 Hz can be selected for this channel; for the DAD 6.1L, DAD 2.1L, MWD 2.1L and PDA-1 also 100 Hz are available.

For the detector UVD 2.1S, the maximum data rate via LAN connection is 50 Hz. For a reproducible integration of a peak, a minimum of 20 data points (better would be 30-40 points) is required. The relation between the selected sampling rate and its suitability for minimum peak width is displayed below in the setup window.



**Note:** It is recommended that you use the peak width (see „Graphical Events Programming“ or if included peak report) to determine the optimal sampling rate for your chromatography. Consequently, at a data rate of 1 Hz the peak should be at least 20 seconds wide. If in doubt about the peak width, choose a higher data rate.

*AUTOZERO AT START:* Check this field if you wish the signal to be zeroed at the moment a measurement is started (to define the current signal as the baseline). Due to its design, a DAD has to perform an autozero. Therefore, disabling this option in this type of detector is not possible.

*AUTOZERO AT WL CHANGE:* Check this field if you wish the signal to be zeroed at the moment of any wavelength change during a run (to define the current signal as the baseline). This option cannot be deactivated for the UV detector 2500 / 2501.

*LAMP OFF AT THE END OF RUN:* Check the lamp *OFF* box to switch off the detector lamp after a measurement is finished. This option may be used for the shutdown methods. The software cannot switch on the lamp prior to a run autonomously. If the lamp is not switched on, a run that has been started will be interrupted.

If the lamp is switched off by software, for all AZURA® L-detectors the lamp will be in off state, if the detector is switched off and on again. You need to switch on the lamp by software before you can start to work with the detector.



**Note:** If the lamp of the detectors DAD 6.1L, DAD 2.1L, MWD 2.1L, PDA-1, UVD 2.1L, S 2520, or S 2550 is switched off via device monitor/software or via method and the device itself is switched off, the lamp is not switched on when the device is switched on. It must be switched on manually in the detector's own setup or with the software via device monitor - *DIRECT CONTROL*.

You should switch the lamp on manually before you start the next working session. After power up, allow 30 minutes for the lamp to stabilize before running samples that may require sensitive measurements.



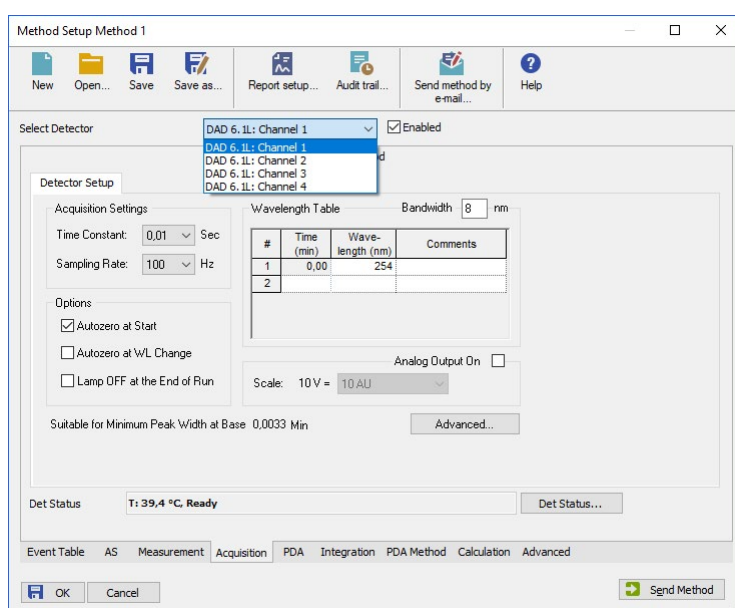
**Note:** An error message, that the software cannot work with a non-validated device means, that the connected detector has not finished self-validation. Either the lamp is switched off (switch on the lamp and wait until self-validation/calibration is finished), The self-validation is still running (wait until end of this procedure) or self-validation is failed (check again with test cell).



**Note:** In case of a fault causing the data acquisition to be terminated, lamp(s) of the detectors is always switched off. Therefore, after a fault the lamp(s) has to be switched on again via the device monitor or on the device itself (does not work via software).

*ANALOG OUTPUT ON* (DAD 6.1L, DAD 2.1L, PDA-1, S 2600/2800/2850 only): An analog output can be activated. Afterwards, a drop-down list with different voltage ranges becomes accessible. For the DAD 6.1L, DAD 2.1L and MWD 2.1L the data rate of the analog output is limited to 12.5 Hz, even if a higher data rate has been set in the method. The analog signal can have a delay of max. 2 seconds in regard of the signal acquired via LAN connection. The data rate of the analog output of the PDA-1 is limited to 10 Hz, even if a higher data rate has been set in the method.

### 8.5.3 Channel depending settings



**Fig. 140:** Acquisition, channel depending settings

In case of multi-channel detectors the wavelength table is only valid for the selected channel. The setup has to be made for all enabled channels separately.

*BANDWIDTH* [nm] (all PDA detectors): The bandwidth is a measure of the range over which the calculations and measurements are used to calculate the intensity for a particular wavelength. For example, with a 10 nm bandwidth, the intensity for 250 nm would be calculated from 245 nm to 255 nm.

A wider bandwidth results in an increased signal to noise ratio because the multiple measurements cause the random noise to be canceled out. Non-random noise is not influenced by a wider bandwidth.

A high bandwidth value will decrease the noise level but also decrease the possible resolution which can be measured. The default value is 8 nm. If your peaks have a significantly wider absorption range, you can enlarge the bandwidth in ClarityChrom® to receive a lower noise level.

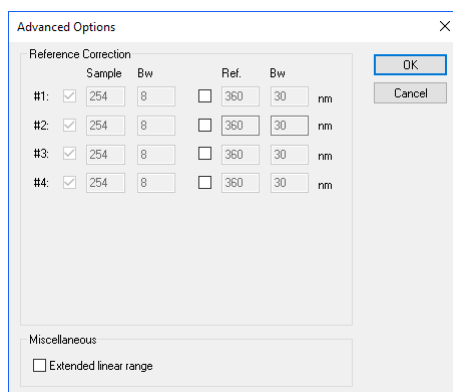
Every channel uses its own wavelength program and measures with its own bandwidth settings. This allows you to achieve the best possible settings for noise and resolution over the whole chromatogram.



**WAVELENGTH TABLE:** In the wavelength table, the time program for every channel can be entered. In the first row (at time 0.00 min), enter the initial wavelength in nm. Then for time in minutes, you can define the wavelength for any desired time. The minimum time difference between two lines is 0.02 minutes. For all PDA detectors, the selected wavelengths in the table have to be in the scan range selected in the PDA settings. The bandwidth has to be taken into consideration as well. Example: If the scan range is 200 - 400 nm and the bandwidth is 8 nm, the maximum allowed wavelength is 396 nm.

The principle of programming the wavelength and time is the same as for programming the gradient, as described on page 101.

### Advanced options



**Fig. 141:** Advanced options for PDA detectors

**REFERENCE CORRECTION:** In order to minimize baseline drift due to refractive index effects, a reference wavelength can be set in order to correct the baseline. The reference should be set in the same spectral region as the signal wavelength (UV or Vis) but at a wavelength at which the analyte has no absorbance. For AZURA® detectors, the reference correction is enabled by default at 360 nm for channel 2.

**SAMPLE:** The sample wavelength is defined in the Acquisition tab.

**BW:** The bandwidth for the sample channels are also defined in the Acquisition tab.

**REF:** Reference is the wavelength at which a reference absorbance is measured as a function of time. It is used to compensate fluctuations caused by baseline adsorption. These fluctuations may be caused, for example, by solvent adsorption during gradient elution. Activate the measuring channels that should be corrected by using a sample measurement.

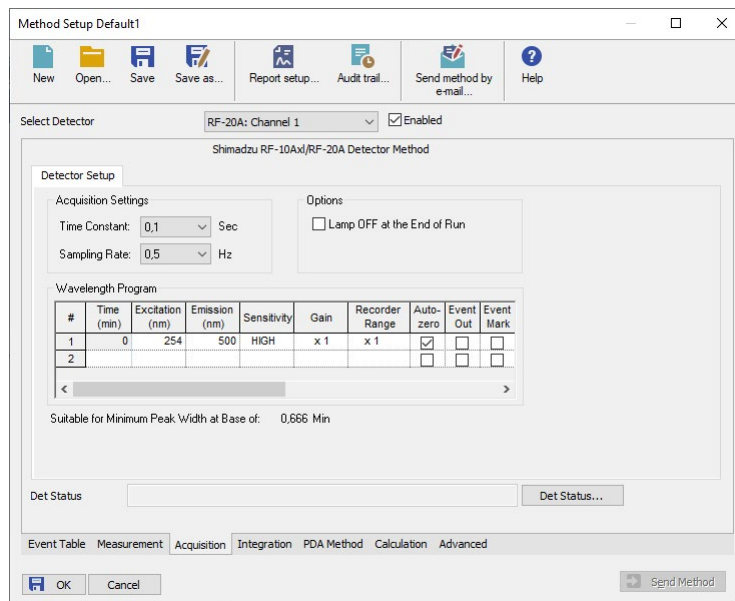
For every measuring wavelength, a sample wavelength can be selected. The selected wavelength must be higher than the sample wavelength and be inside of the scan range stated under PDA. Enter the bandwidth of the reference wavelength. Limits are 1 to 32 nm in 1 nm steps. It indicates the range in which adsorption can be measured.

**EXTENDED LINEAR RANGE (ONLY DAD 6.1L, DAD 2.1L, MWD 2.1L):** Upon activating the extended linear range option it is possible to broaden the linear range of the AZURA® detector, through internal stray light correction. For DAD 2.1L and MWD 2.1L this option will be available in firmware versions from 1.10, for DAD 6.1L from firmware version 1.23. If not supported, an error message will be displayed.



## 8.5.4 Acquisition spectrofluorometric detector RF-10Axl/20A/20Axs

The wavelength program allows for setting up the extinction and emission wavelength as well as for the signal amplification. KNAUER recommends to start with sensitivity *HIGH*. More information for the options and their effect you can find in the detector manual.



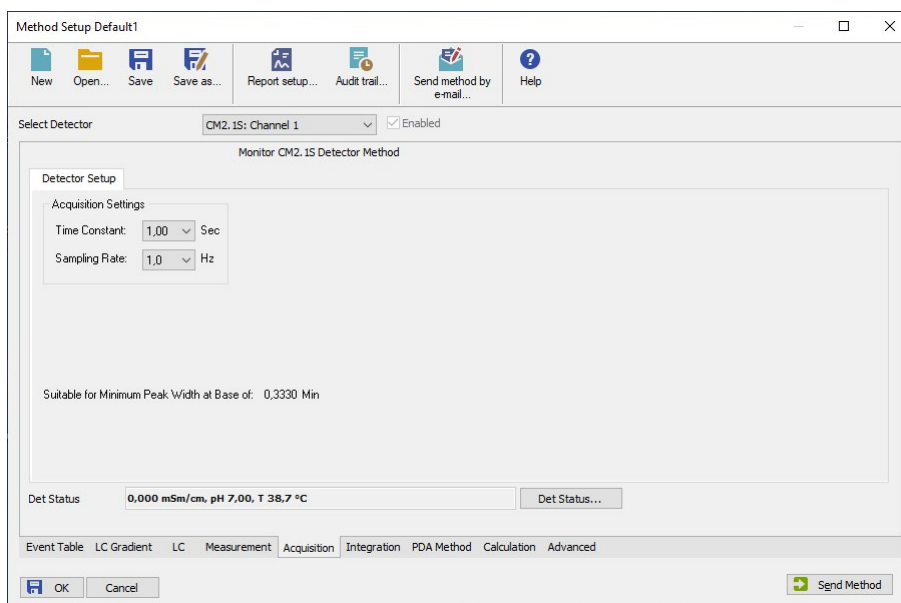
**Fig. 142:** Acquisition, Shimadzu RF-10Axl / RF-20A/Axs



**Note:** The driver only works with detector firmware 0.90 for the detector RF-20A/Axl. The functionality is limited on the functions of the predecessor RF-10. Especially the options for data acquisition on two independent channels (so called 4 channel wavelength mode) or tempering the measurement cell are not supported. Wavelength scans cannot be programmed, executed or stored in a method. If you switch off the detector's lamp by method, you must switch on the lamp again manually. This can be done in the device monitor - RF-20A - Diagnostics. Scans, executed in the device monitor, cannot be stored.

## 8.5.5 Acquisition conductivity monitor AZURA® CM 2.1S and Smartline S 2900

The S 2900 conductivity monitor does not require a setup window in the method setup. Additional data tracks for pH value and the temperature can be activated in the *ADVANCED* tab, in the table *AUXILIARY SIGNAL*.



**Fig. 143:** Acquisition, CM 2.1S setup

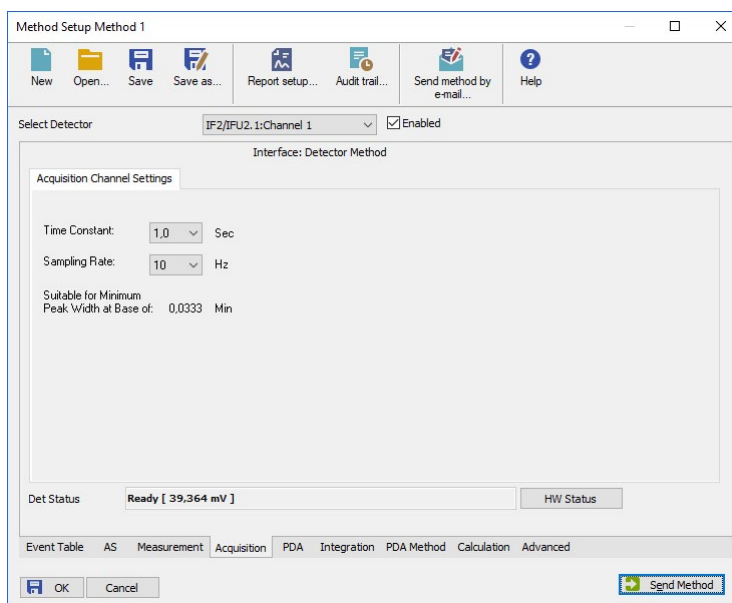
**TIME CONSTANT:** Select the time constant from the drop-down list. The options are 0.0, 0.1, 0.2, 0.5, 1.0, AND 2.0 sec. Smaller time constants are required for high speed analyses. A good rule is to select a time constant, which is the reciprocal of the selected sampling rate. The relation between the selected sampling rate and its suitability for minimum peak width is displayed below in the setup window.

**SAMPLING RATE:** This is the rate at which data will be sampled by the system. This selection is in Hz (data points per second). Select it from the drop-down list. The options are 1, 2, 5, AND 10 Hz. For a reproducible integration of a peak, a minimum of 20 data points (better would be 30-40 points) is required. The relation between the selected sampling rate and its suitability for minimum peak width is displayed below in the setup window.



**Note:** It is recommended to choose a data rate which still uses 20 data points to describe the narrowest peak of interest. Consequently, at a data rate of 1 Hz the peak should be at least 20 seconds wide. If in doubt about the peak width, choose a higher data rate.

## 8.5.6 Channel dependent settings - User defined detector



**Fig. 144:** Acquisition, user defined detector settings

*CHANNEL ENABLED ON:* Activate this option to acquire data from the data via the A/D converter.

*TIME CONSTANT:* Select the time constant from the drop-down list. The options are 0.1, 0.2, 0.5, 1.0, 2.0, 5.0, and 10.0 sec. Smaller time constants are required for high speed analyses. A good rule is to select a time constant, which is at least one tenth of the peak width at the base of the narrowest peak of interest.

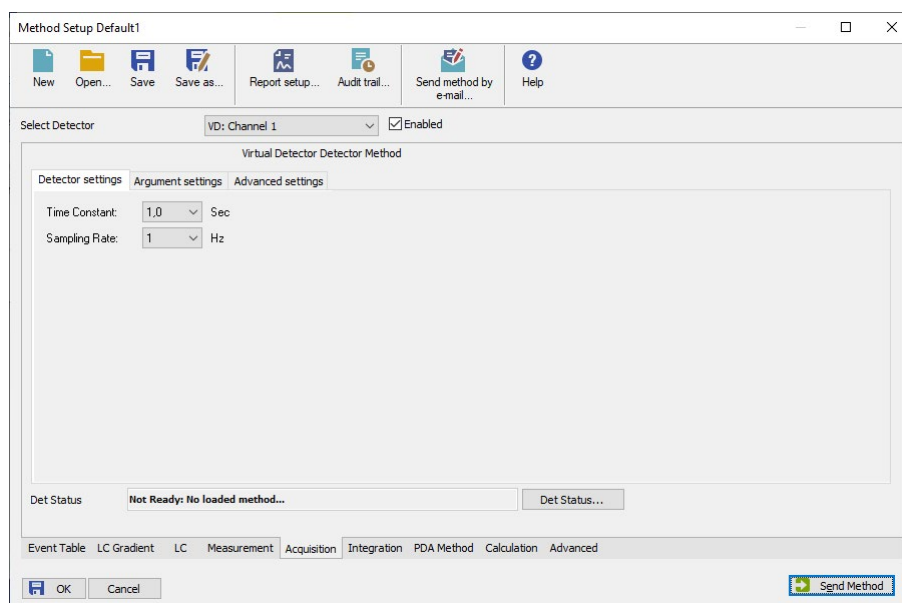
*SAMPLING RATE:* This is the rate at which data will be sampled by the system. This selection is in Hz (data points per second). Select it from the drop-down list. The options are 1, 2, 5, and 10 Hz. For a reproducible integration of a peak, a minimum of 20 data points (better would be 30-40 points) is required.

The relation between the selected sampling rate and its suitability for minimum peak width is displayed below in the setup window. If the 50 Hz (Manager 5000/5050/M-1, IF2/IFU) or 100 Hz (KNAUER HPLC Box) option has been activated in the configuration of the A/D converter, this sampling rate is also available. If so, only channel 1 is accessible, channels 2-4 are disabled.

## 8.5.7 Channel dependent settings - Virtual detector

A virtual detector is not a real instrument but a software tool having special functions. For instance, it is possible to carry out simulations or corrections of chromatograms with this "detector". The result will be stored as normally created chromatogram.

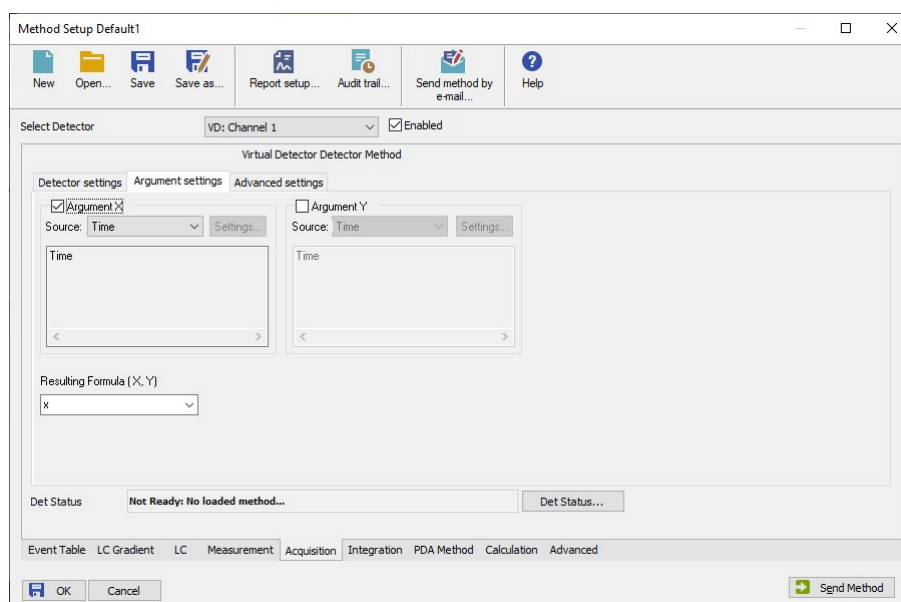
The virtual detector requires the same general settings as any other detector.



**Fig. 145: Acquisition, virtual detector settings**

**Time Constant:** Select the time constant from the drop-down list. The options are 0.1, 0.0, 0.1, 0.2, 0.5, 1.0, and 5.0 sec.

**SAMPLING RATE:** This is the rate at which data will be sampled by the system. The *SAMPLING RATE* is displayed in Hz (data points per second). Select it from the drop-down list. The options are: 1, 2, 5, 10, 20, 50, and 100 Hz. For a reproducible integration of a peak, a minimum of 20 data points (better would be 30-40 points) is required.



**Fig. 146: Acquisition, virtual detector, argument settings**

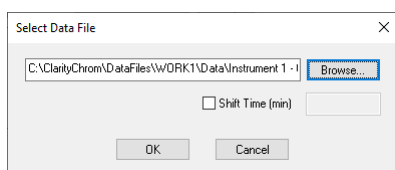
**ARGUMENT X:** X and Y are optional arguments; use of these can be switched off. A result formula can be calculated without neither X nor Y, with only X or with both X and Y. Solely using Y is not allowed. If using X or Y is switched on, „X“ and „Y“ signs must be used in the result formula expression.

After the *X* or *Y* field has been activated, the respective drop-down list for selecting the data source becomes accessible. The options are *TIME*, *DATA FILE*, and *EXTERNAL SOURCE*.

*TIME*: With this selection no further settings for argument *X* are possible. The argument value is equal to the current time value.

*DATA FILE*: The value of this argument is calculated using the corresponding point in the selected data file. For example, for time 10 seconds (if sampling rate is 1), 10 points will be extracted from the data file. This way, an existing chromatogram can be retraced. If a sampling rate different from the sampling rate set for the original chromatogram is selected, the chromatogram will be drawn faster or slower. If the original file offers more points than are needed, the missing data values are displayed as 0 (zero).

*SETTINGS*: The *SETTINGS* button becomes accessible. Clicking on it the following dialog box appears.

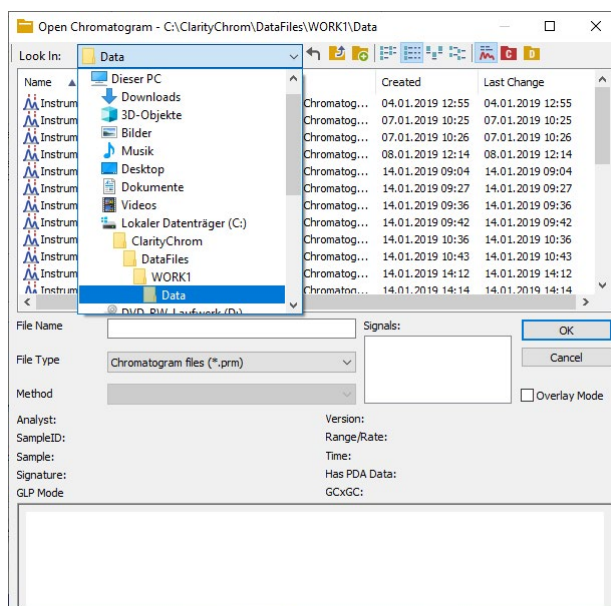


**Fig. 147:** Virtual detector settings, data file selection

The last selection is displayed. You can either enter a new data path or you can select it via the *BROWSE...* button.

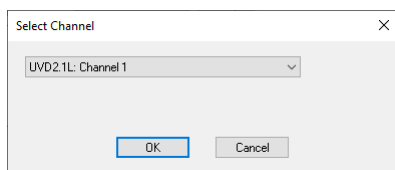


**Note:** To avoid possible signal distortion, the Y-Axis multiplier in the configuration of the virtual detector must be equal to that of the selected User Detector.



**Fig. 148:** Virtual detector settings, data file selection

*EXTERNAL SOURCE:* The *SETTINGS* button becomes accessible and clicking on it will open the following window:



**Fig. 149:** Virtual detector settings, channel selection

From the drop-down list, you can select any detector channel configured in the system. If you use two different detectors for arguments *X* and *Y*, you can combine the chromatograms of both detectors into one chromatogram. This is a useful option, e.g. for fraction collection, if not all components can be determined by one detector.



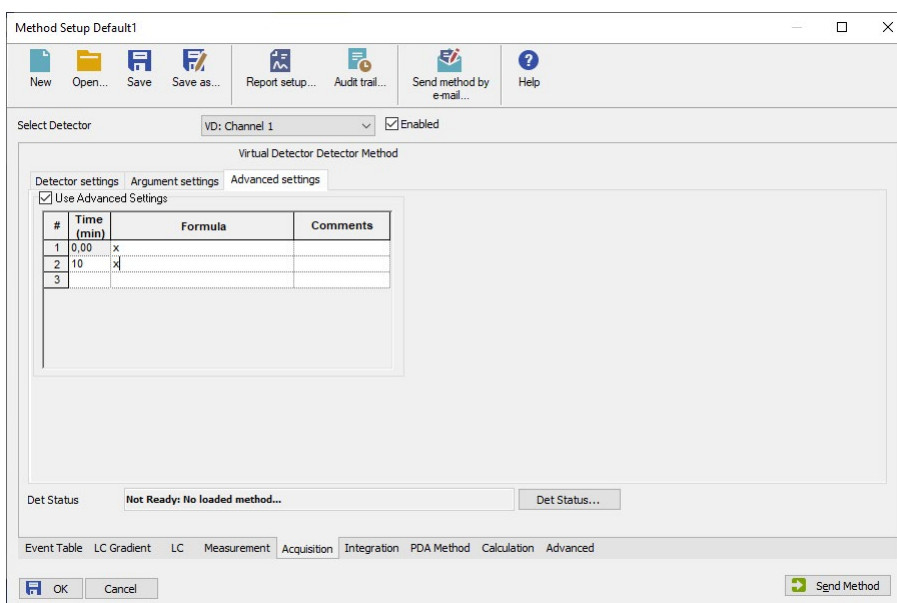
**Note:** To avoid possible signal distortion, the Y-axis multiplier in the configuration of the virtual detector must be equal to that of the selected User Detector.

*ARGUMENT Y:* This option becomes accessible, if the *ARGUMENT X* field is activated. The setting dialogs for *Y* are than the same as for *X*.

*FORMULA (X,Y):* You can enter the formula directly. All used previously used formulas can be selected via drop-down list as well.

*FORMULA POSSIBILITIES:* Following functions, constants, and operations will be supported:

<b>Functions:</b>	<b>SIN, COS, TG, ASIN, ATG, EXP, SQRT, ABS</b>	
	<b>LG</b>	<b>log10</b>
	<b>LN</b>	<b>ln</b>
	<b>SH</b>	<b>hyperbolic sine</b>
	<b>CH</b>	<b>hyperbolic cosine</b>
	<b>TH</b>	<b>hyperbolic tangent</b>
	<b>RAND ()</b>	<b>randomizer</b>
<b>Constants:</b>	<b>PI</b>	<b>p = 3.141592653</b>
	<b>E</b>	<b>e = 2.71828183</b>
<b>Operations:</b>	<b>+</b>	<b>addition</b>
	<b>-</b>	<b>subtraction</b>
	<b>*</b>	<b>multiplication</b>
	<b>/</b>	<b>division</b>
	<b>^</b>	<b>power</b>
		<b>unary plus and minus</b>

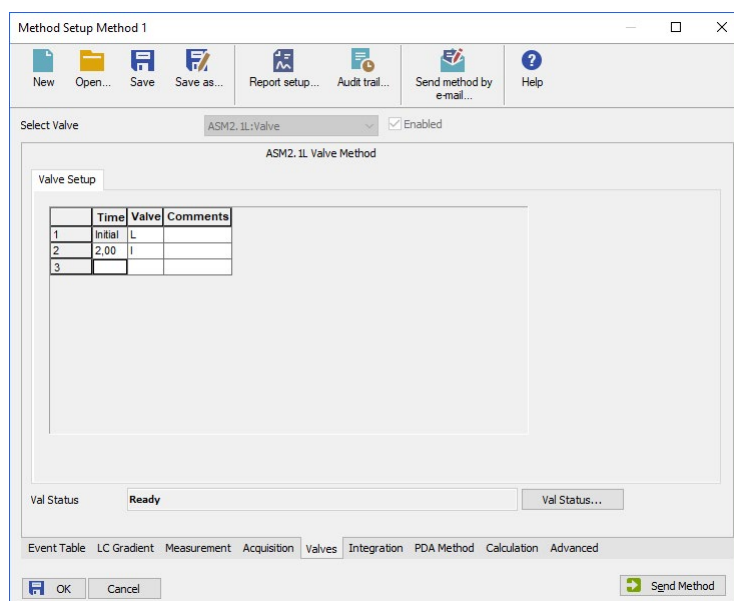


**Fig. 150:** Acquisition, virtual detector, advanced settings

Selecting this tab and activating the option *USE ADVANCED SETTINGS* a time table for changing the formula during a run becomes accessible.

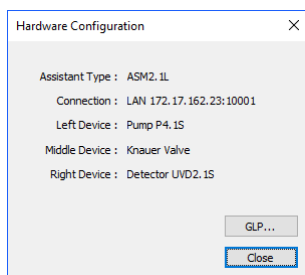
## 8.6 Assistants ASM 2.1L / ASM 2.2L Setup

Due to the modular system, there are a lot of possible configurations for the assistants. There is no ASM setup window, which would include the setup of the assistant modules. All modules will be shown as “single” devices (pumps, detectors, valves, MultiValve FC). In the *SELECT ...* bar, the name of the selected assistant and the module name will be displayed.



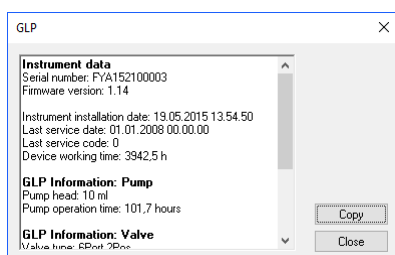
**Fig. 151:** Setup window for switching valves “Valve” of the ASM 2.1L

Click ...*STATUS* to open the status window for the assistant device. The status of all configuration modules will be shown.



**Fig. 152:** Status information (hardware configuration) of the ASM 2.1L valve, valve, pump

Click *GLP...* to show the GLP information for all configured assistant modules.



**Fig. 153:** GLP information of the ASM 2.1L valve, valve, pump

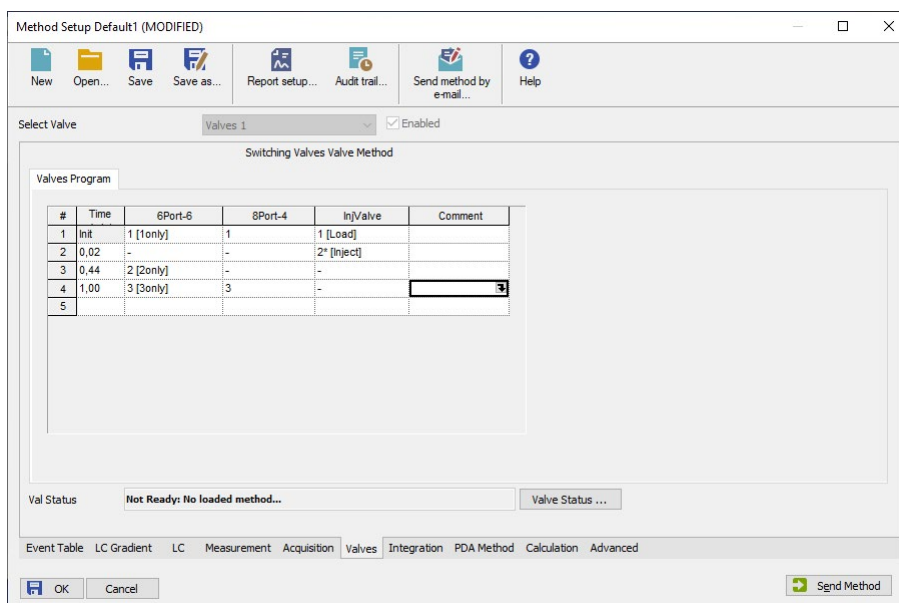
## 8.7 Setup switching valves

The method setup - *VALVES* window includes one tab as described below and a tab independent button *Val Status*.

*VAL STATUS*: *VAL STATUS* reads out and displays a status summary.

*VALVES PROGRAM*: Use this valves program spreadsheet to enter your time program. The number of columns corresponds to the number of configured valves. In the first row (at time *Init*), enter the initial position for each valve. All other switching statuses and times can be freely selected.







**Fig. 154:** Setup window for the Switching Valves

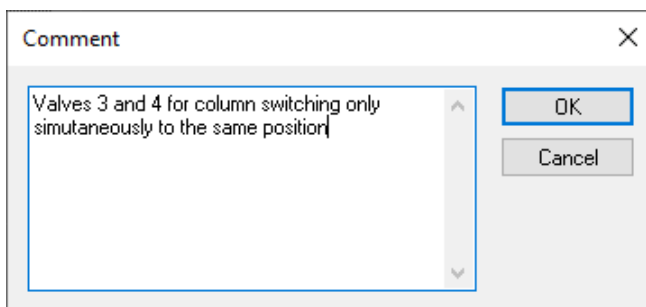
*VALVES PROGRAM:* The options are *BLANK* (-), *I* (Inject), and *L* (Load) for 2-position valves and *1* through *6* (*12*, *16*) for 6- (*12*-, or *16*-) position valves. The *BLANK* (-) selection means that the valve will not change its state at the given time. If valve positions are named in configuration, the names will be shown.

For AZURA® VU 4.1 for the injection valve the positions will also be shown as 1 and 2 instead of I and L. If an event is enabled for a position, it will be represented with a \*.

The values can be entered directly or selected from the drop-down list. The corresponding button  appears as soon as the respective field is selected.

The principle of editing the valves program table is the same as described for the gradient table in chapter „LC Gradient“ on page 102.

If you select any field in the comment column, the  button will appear, which allows you to open a comment window.



**Fig. 155:** Setup window, KNAUER Switching Valves, comments

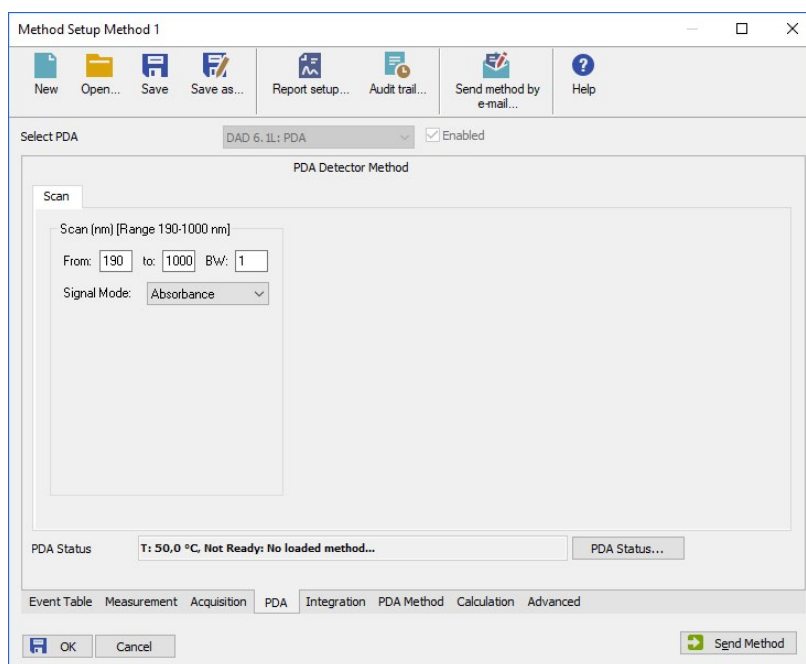
## 8.8 PDA, Detector method

The method setup / PDA window includes a tab as described below and a tab independent button PDA Status.

*PDA STATUS*: *PDA STATUS* reads out and displays a status summary.

*SELECT PDA/ENABLED*: *SELECT PDA* and the field *ENABLED* are not accessible and only offer information as soon as a PDA is configured and added to the system.

### 8.8.1 PDA, Scan



**Fig. 156:** PDA, Scan

*SCAN, NM* [Range x-x nm]: This area is used to specify spectral parameters used for your test measurements. The range displays the minimal and maximal wavelengths available for the detector. The wavelength range depends on the detector; the range depicted is just an example. If a detector is connected and switched on, the physical scan limit of the detector will be shown. If not, default values for the scan range (detector dependent) will be displayed.

*START, END/FROM, TO*: *START/FROM* is the minimal wavelength. The default value is 200 nm *END/TO* is the upper limit of the current scan. The default value is defined by the configuration. 3D data is acquired within this defined range. Please note that all wavelengths monitored separately under Acquisition in the wavelength program and their selected bandwidths have to be within the selected scan range.

*BANDWIDTH/BW*: The bandwidth is the wavelength range that is used to measure a data point of the spectrum. For the spectra acquisition, it is highly recommended to use a bandwidth of 1 nm to receive a clean spectrum.

*SIGNAL MODE*: Select the signal mode from the drop-down list. The choices are *ABSORPTION* or *INTENSITY*. For a data acquisition in HPLC usually *ABSORPTION* will be used.

## 8.9 PDA Method

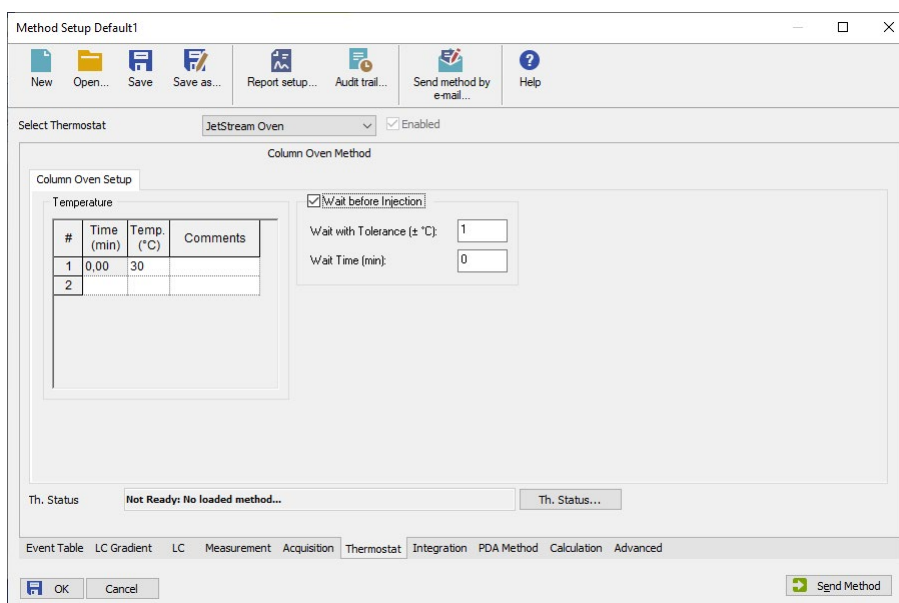
Displays the PDA method for several settings when the PDA Module is active. Detailed description is provided in a separate PDA manual.

## 8.10 Thermostat (column ovens)

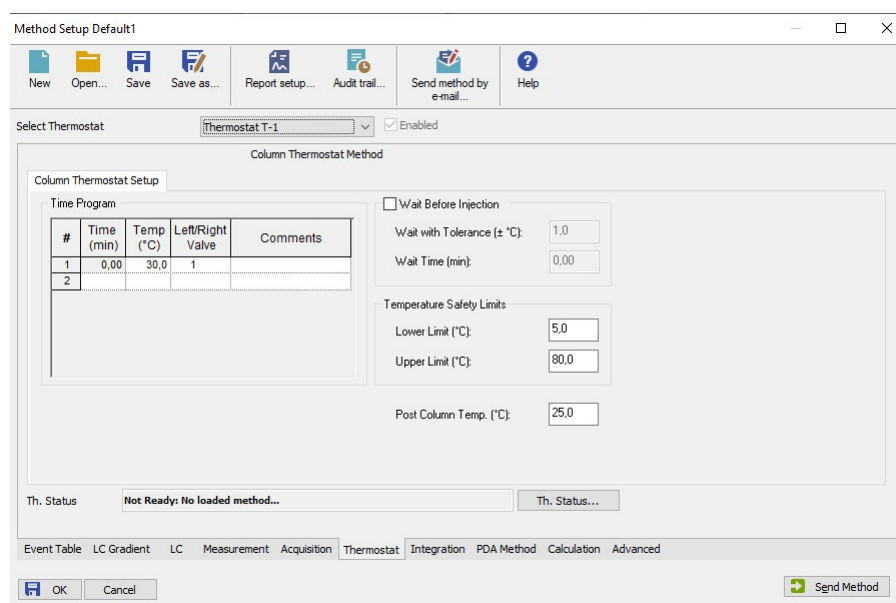
The method setup - *THERMOSTAT* window includes a tab and a tab-independent switch *TH. STATUS*, which is explained below.

*TH. STATUS*: *TH. STATUS* reads out and displays a status summary.

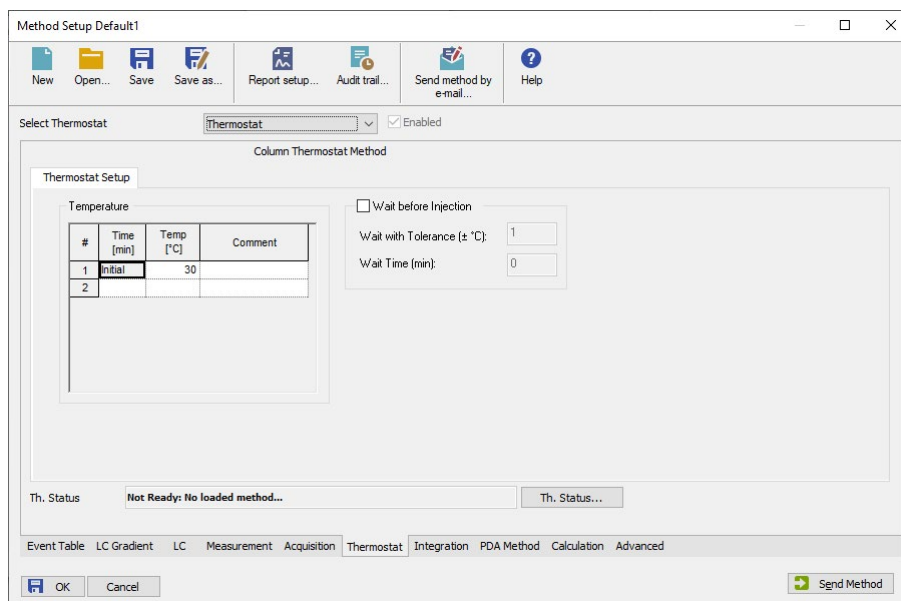
*SELECT THERMOSTAT, ENABLED*: *SELECT THERMOSTAT* and the field *ENABLED* are not accessible for changes and only offer information as soon as a thermostat is configured and added to the system.



**Fig. 157:** Setup window JetStream



**Fig. 158:** Setup window column thermostat T-1



**Fig. 159: Setup window column thermostat CT 2.1**

*TEMPERATURE, TIME PROGRAM:* Enter your time program. For details on the spreadsheet operations, refer to the section gradient table in chapter „LC Gradient“ on page 102. The allowable temperatures depend on the column thermostat model. Please keep in mind the maximum heating and cooling rate of your column thermostat when you enter the temperature gradient.

*LEFT VALVE, RIGHT VALVE, TIME PROGRAM (T-1 only):* If your column thermostat T-1 is equipped with valves, you can time-program them. If you have activated the check box *COLUMN SWITCHING OPTION* in the configuration, you can only set one position to which both valves are switched synchronously.

*WAIT BEFORE INJECTION:* The settings *WAIT WITH TOLERANCE* ( $\pm$  °C /  $\pm$  °F /  $\pm$  K, dependent from the settings in the *INSTRUMENT METHOD SENDING* menu) and *WAIT TIME* (min) allow the autosampler to wait for an injection until the start temperature set in the temperature program is reached in the oven.

Prior to every injection, the autosampler will wait until the start temperature is reached and the *WAIT TIME* has elapsed. During a single run, this setting has no effect, the run is started immediately, even if the set target temperature has not been reached yet.

*COOLER TEMPERATURE* (Smartline Oven 4050 only): Settings from 5° up to 30° are allowed.

*LEAKAGE SENSOR ALARM* (Smartline Oven 4050 only): This setting regulates the sensitivity of the leak sensor. Values from 1 through 100 are possible. Setting 1 is related to the highest and setting 99 to the lowest sensitivity of the sensor. With setting 100 the sensor is switched off. For the T-1 and the CT 2.1, the leak sensor alarm is set in the configuration. The leak sensor of the JetStream oven cannot be controlled via software.

*TEMPERATURE SAFETY LIMITS* (CT 2.1, T-1 only): A *LOWER LIMIT* and an *UPPER LIMIT* temperature range can be defined. The values must be set between 2,0 and 85,0 °C. The temperature set under *TIME PROGRAM* may not be outside the selected limit.

*POST COLUMN TEMP.* (T-1 only): *POST COLUMN TEMP.* determines the pre-column temperature. The values must be between 15,0 and 35,0 °C.



**Note:** If the operating panel has been connected to the column thermostats CT 2.1 and JetStream, *CHOOSE FUNCTION* has to be displayed on the panel as the default value when the instrument is opened. Otherwise, it cannot be accessed.

## 8.11 Integration

The button *METHOD SETUP ACQUISITION · INTEGRATION* opens the dialog window in which you can set the integration parameters. For a detailed description, see the „Clarity reference guide“, chapter 2.3.4 - Integration.



**Note:** When using a multi-detector configuration, each detector will have its own integration table.

## 8.12 Calculation

The button *METHOD SETUP CALCULATION · CALCULATION* opens a dialog window in which you can determine how calculations should be displayed. In the dialog tab *ADVANCED*, further parameters for the calculations can be entered. For a detailed description, see the „Clarity reference guide“, chapter 2.3.5 - Calculation. When utilizing a multi-detector chromatogram, the tab will be common to all signals.

## 9. Setup and programming fraction collectors

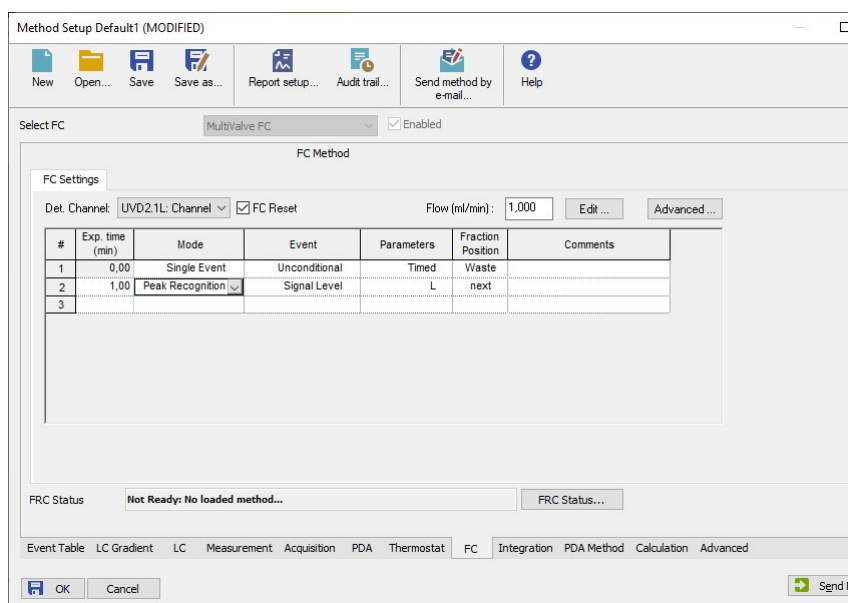


Only one fraction collector can be configured per system. The setup procedures and programming for all fraction collectors supported by ClarityChrom® are identical and are therefore described collectively and not per device.

**DET. CHANNEL:** The field *DET. CHANNEL* controls the fraction collection. From the drop-down list, select the detector (channel) whose signal shall be evaluated for the fractioning. Only one detector or one detector channel (for multi-wavelength detectors) can be selected. If two detector channels are required, it can be realized using a virtual detector (refer to chapter „Configuration - virtual detector“ on page 54).

**FC RESET:** This option must be checked for cumulative collection from repeating runs. For each injection the fraction collector starts then with the first programmed fractionation vial. All fractions of each injection will be collected in the same vials. This is useful in case the sample solution shall be injected multiple times.

All information about the fractions collected before will be deleted (refer to *SHOW RACK* in the collectors device monitor). This is applicable for all single analysis and for multiple starts of (a) sequences. For all injections, made in one sequence run, the software stores the filling level to prevent, that the fractionation vials will be overfilled. If the *FC RESET* option is disabled, each fraction from each injection will be collected in a separate vial. In case no empty vial accessible, the run will be interrupted.



**Fig. 160:** Fraction collector settings

**FLOW (mL/min):** Enter the flow rate of the pump. This information is needed to calculate the time or volume delay as well as to calculate the filling level of the fractionation vial. The time or volume delay is the time that a peak requires to move from the detector's flow cell to the fractionation vial (also refer the Tubing Parameters in the fraction collector's configuration setup).

The filling level calculation prevents an overflow of the fractionation vial (also refer to *FC RESET*). It is important that the flow rate of the pump remains at a constant level across the whole run; changes in the flow rate during the run cannot be considered.

*EDIT...: EDIT...* opens the window for programming the fractionation, also with the help of a chromatogram, see also „9.2 Editing of fraction collection programs“ on page 134.

*ADVANCED...:* In the *ADVANCED* settings menu you can select whether the *NEXT* position is counted from vial 1 (Next from first) or from the current position (Next from current). The first option automatically will use all free vials before the system may stop due to that no free vials are available. The second option allows to use *NEXT* from also another position, what may help to keep the survey especially for fraction collectors with a higher number of fraction positions.

FRC Status displays a status summary of the involved collector.

## 9.1 Fraction collection program (FC settings)



The principle of programming the fraction collector is the same as described for programming the gradient, as described on page 99. Some fields are free for entering data whereas others are either only for information purposes (without access) or for selecting between possible options via a drop-down list.

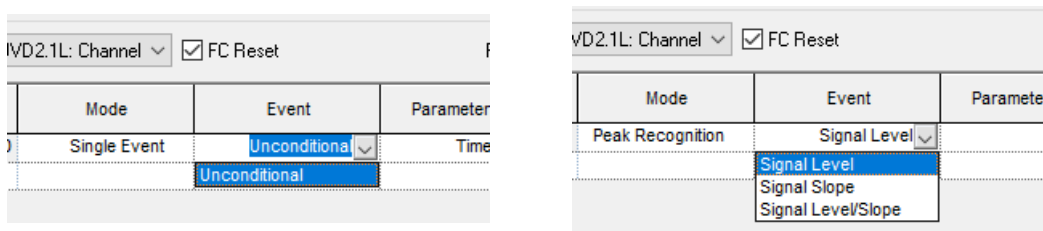
*EXP. TIME* (min): Enter the desired (expected) time values for the fractionation event.

*MODE:* In the *SINGLE EVENT* modus, the actions (collect or move to waste) of the fraction collector at a certain point of time can be defined, while the mode *PEAK RECOGNITION* reacts to the detector signal and executes pre-set actions (collecting, recycling, moving to waste) if given conditions are met. The parameters are valid until another line with other parameters is executed from the fractionation table. If no other line is available, the conditions apply to the entire run. In the mode *PEAK RECOGNITION*, every newly detected peak according to the defined thresholds (see Parameters option below) will be collected in the next empty vial.

The *NEXT* empty vial is either defined as the next not used vial, seen from vial position 1, or the next not used vial from the current collection position. This can be defined in the *ADVANCED...* menu. With the action *COLLECT TO*, a vial position may be reserved in the mode *SINGLE EVENT*. In this position, there is no collection via *NEXT* because a vial is not free. It is skipped as if it was the next vial. The display and the possibilities of the following settings depend on the selected mode.

It is highly recommended to insert the following line into the program at the end of the run time (defined in the tab *MEASUREMENT*) with mode: *SINGLE EVENT*; *EVENT: UNCONDITIONAL*; *PARAMETERS: WASTE*. This line causes the valve to switch the fraction collector to waste at the end of a run. If a fraction has been collected close to the end of a run, it may happen that the fraction collector continues to collect after the run has ended.

*EVENT:* The possible options displayed depend on the selected mode:



**Fig. 161:** Event definition

*SINGLE EVENT - UNCONDITIONAL*: Signal-independent action at a programmed point of time, as selected in the parameter window.

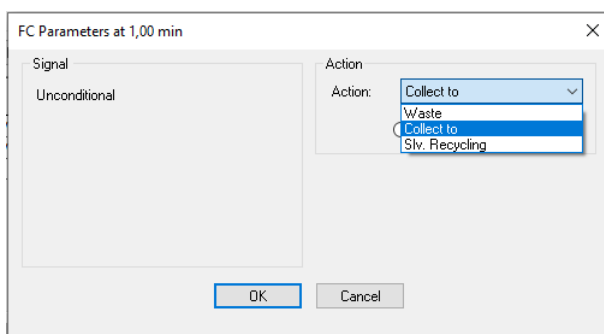
*PEAK RECOGNITION - SIGNAL LEVEL*: The collection takes place according to set level thresholds. The parameters are valid until another line with other parameters is executed.

*PEAK RECOGNITION - SIGNAL SLOPE*: The collection takes place according to set slope thresholds. The parameters are valid until another line with other parameters is executed.

*PEAK RECOGNITION - SIGNAL LEVEL/SLOPE*: The collection takes place according to set level and slope thresholds which can be combined in logical *AND/OR* combinations. The parameters are valid until another line with other parameters is executed.

*PARAMETERS*: By activating any field in this column, an arrow will appear. By clicking on this arrow a dialog box for the FC parameters at that selected time will be opened. Its appearance will depend on the mode as well as on the selected event.

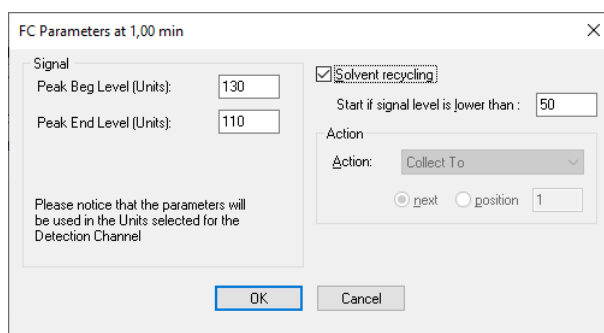
#### Parameter Single Event - *UNCONDITIONAL*



**Fig. 162:** FC parameters *UNCONDITIONAL* (single event)

Only the type of action (and in case of Collect to the destination vial/position) is to be selected. *COLLECT TO* allows defining a vial position for a fraction. *NEXT* means the next not used vial, seen from vial position 1, not from the current collection position. The option *SLV. RECYCLING* (solvent recycling) is only available if a recycling valve has been configured during the configuration of the fraction collector. Due to that the signal level will not be checked, make sure that during the solvent recycling no components will elute. After closing the window the parameter will be designated as *TIMED*.

#### Parameter Peak Recognition - *SIGNAL LEVEL*



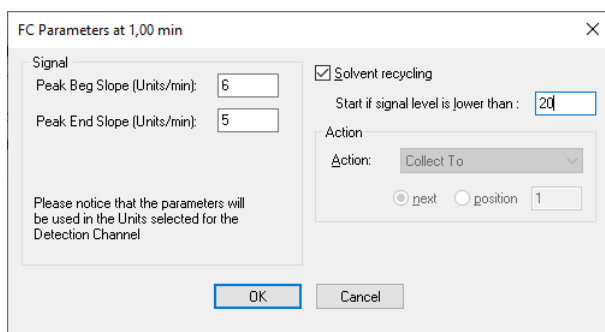
**Fig. 163:** FC parameters *SIGNAL LEVEL* (peak recognition)



In the case of peak recognition mode and event *SIGNAL LEVEL*, the parameter window will enable you to enter the threshold values for the peak at the beginning and at the end. This action refers to the next free vial (*COLLECT TO NEXT*, next unused vial from vial position 1). All peaks, which meet the programmed threshold, are now collected. The base line has to approach the threshold from below (lower values). If the detector measuring value exceeds the peak end level, the collection is stopped.

If a recycling valve has been configured, you can also activate the *SOLVENT RECYCLING* option with a corresponding threshold. After closing the window, the parameter will be designated as *L* without leading sign.

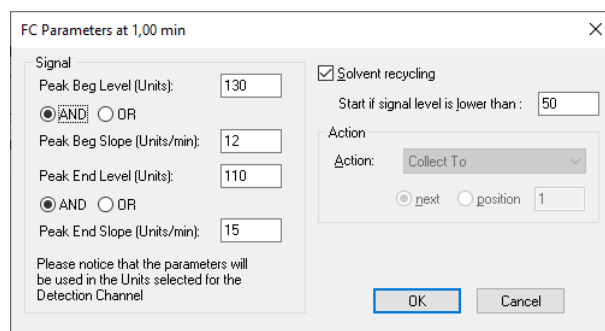
**Parameter** Peak Recognition - *SIGNAL SLOPE*



**Fig. 164:** FC parameters *SIGNAL SLOPE* (peak recognition)

When using the *SIGNAL SLOPE* instead of the *SIGNAL LEVEL*, the settings are made similarly. The only difference is that the slope values (defined as signal difference per 1 sec) are to be used as thresholds. Only positive values of slope are accepted in this window. For the *SOLVENT RECYCLING* (only available if a recycling valve has been configured) the signal level has to be entered, not the signal slope. After closing the window, the parameter will be designated as *S* without leading sign.

**Parameter** Peak Recognition - *SIGNAL LEVEL/SLOPE*



**Fig. 165:** FC parameters *SIGNAL LEVEL/SLOPE* (peak recognition)

Peak recognition using the slope and the level is performed similarly as described above. The only difference is that both the level and slope values are to be used as thresholds. Then you have to decide how the thresholds should be logically connected (*AND*, *OR*). This can be defined differently for the ascending and descending flange of the peak.

After closing the window the parameter will be designated for example as *LB AND SB - LE AND SE*.

**SOLVENT RECYCLING:** Check this option if a solvent recycling valve is configured and you want to perform solvent recycling.

Enter the signal threshold for the solvent recycling option. Recycling will be activated if no peak is currently collected and the signal is lower than the threshold.

**ACTION:** In Single Event mode, the action can be selected. *WASTE*, *COLLECT TO*, and *SOLVENT RECYCLING* are possible. For the mode Peak Recognition the action is set to *COLLECT TO NEXT*.

**ACTION - WASTE:** The eluate will be directed to waste.

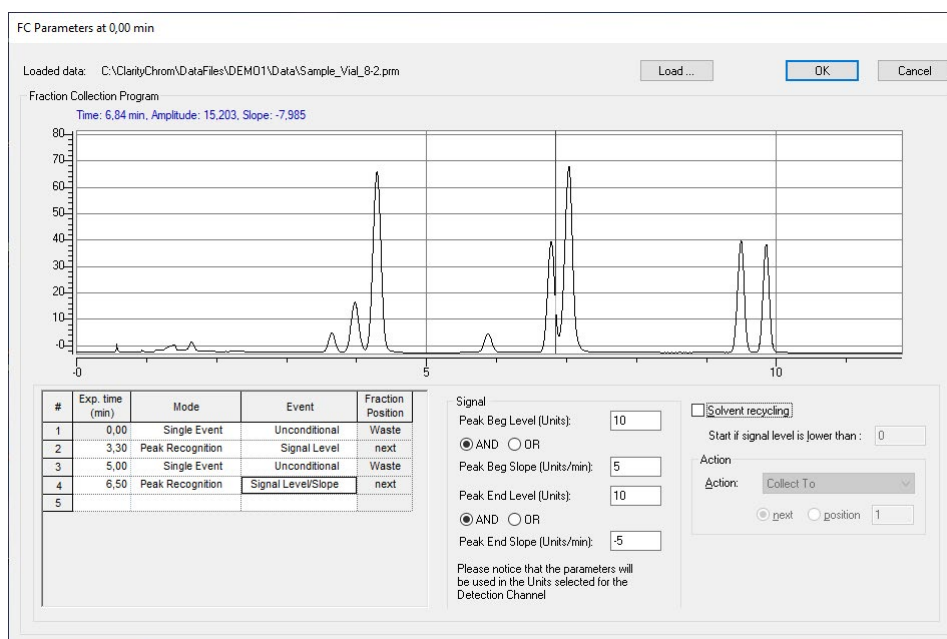
**ACTION - COLLECT TO:** The eluate will be directed to the set position. Either *NEXT* (the next free vial from vial position 1) or a fixed vial number can be selected.

**ACTION - SOLVENT RECYCLING:** The eluate will be collected in a recycling container because its purity is better than the set limits.

**FRACTION POSITION:** This field is for information purposes according to the settings in the parameter window. Either the defined vial position is displayed or *NEXT* for the first free vial position. Additional possibilities are *WASTE* and *SOLVENT RECYCLING*.

## 9.2 Editing of fraction collection programs

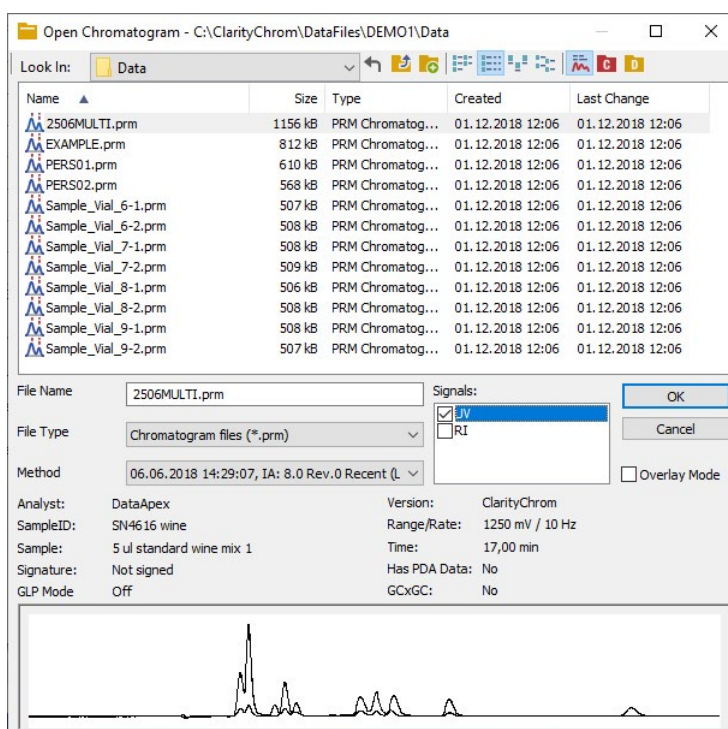
**EDIT...:** As an alternative for the direct programming of the fraction table or as an additional option, click the Edit button to open the FC program editing tool which allows also for graphical programming of fractionation.



**Fig. 166:** Programming window for the fractionation

**LOADED DATA:** The path for the currently opened chromatogram is displayed in this field.

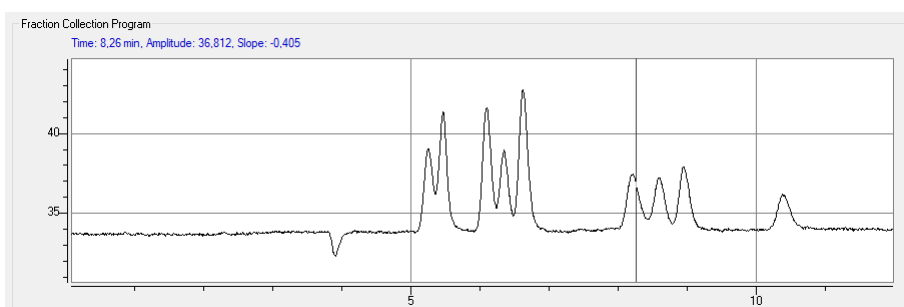
**LOAD...:** Click the *LOAD...* button to open the desired chromatogram to be used for defining the fractionation settings. A window which allows for selecting the desired chromatogram will appear.



**Fig. 167:** Open chromatogram window

Click on the desired chromatogram. If there is more than one signal (trace) in the data file, select only one signal. Press the *OK* button to load the selected chromatogram to the editing tool.

Moving the cursor inside the graph area will cause it to become a cross hairs. In addition, a vertical line will appear. Depending on the position of the cursor, the actual values for *TIME*, *AMPLITUDE* (level) and *SLOPE* will be displayed directly above the graph.



**Fig. 168:** Opened chromatogram in setup window

Move the cursor to the desired position and double-click with pressed *Ctrl* key. In the fraction collection program a new line will be created and the parameter window for this line will contain the current time, level, and slope values. By default, the peak recognition mode with the signal level/slope event will be suggested. Complete the parameter settings as necessary and click to another line in the fraction table to apply the settings. Repeat this procedure as often as required to program additional events.

---

You can also program the collection events directly in the table. The parameters for the selected event you can enter in the right-handed part of the window. The options are identically with the table programming as described above.

Keep in mind to insert the following line into the program at the end of the run time (defined in the tab *MEASUREMENT*) with *MODE: SINGLE EVENT; EVENT: UNCONDITIONAL; PARAMETERS: WASTE;* to cause the valve of the fraction collector to switch to Waste after the end of a run.

When complete, click *OK* to exit the dialog and return to the method setup window.

## 10. Device Monitor

Clicking on the *DEVICE MONITOR* icon of the instrument window will open the device monitor displaying status information and enabling online settings.



**Fig. 169:** Instrument window

The design of the device monitor of course depends on the configured system. The monitor is divided in two sections the monitoring and the *DIRECT CONTROL* area. The *DIRECT CONTROL* area allows entering and executing parameters independent of which method parameters are currently set.

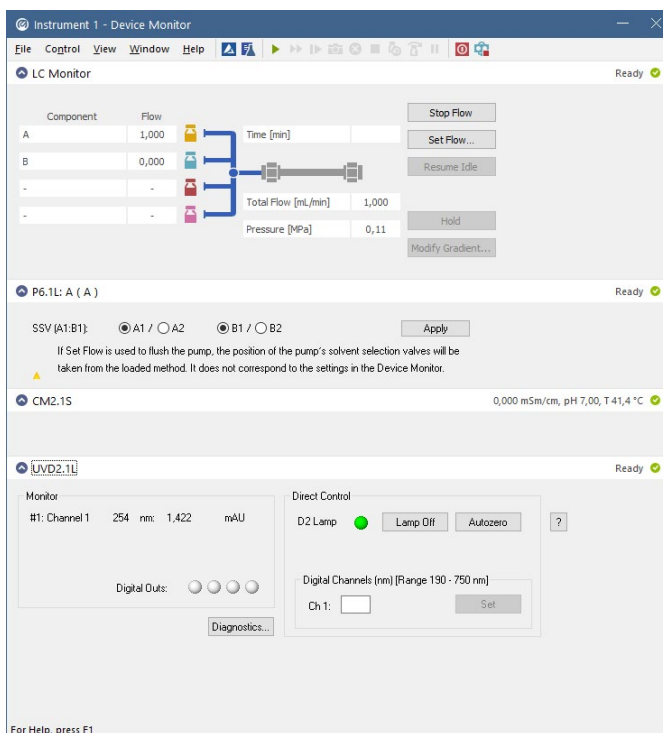
Note that prior to starting a run (*SINGLE ACQUISITION*), the method has to be loaded again. Otherwise the devices would run with the parameters sent by the *DIRECT CONTROL*. This is necessary because the method is not re-loaded for a single acquisition prior to the start.



**Note:** If device parameters will be sent to a device from the Device Monitor, the previously loaded method will be deleted from the device. If a run is started afterwards, it is not performed with the original method parameters but with the parameters sent via the Device Monitor. To load the method parameters again for a run, send the method again by using the Send Method button in the instrument window, Single...Analysis window or the method setup. You can also reload the method by clicking *FILE · LOAD METHOD* in the method window. This step is not necessary if you want to start a sequence next because the method will always be reopened and the method parameters will be sent to the devices.

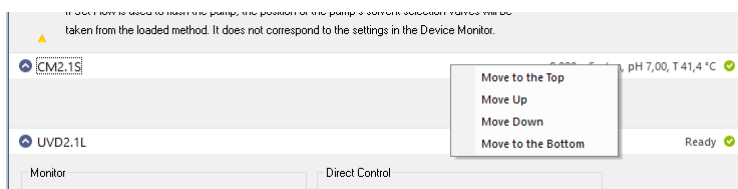


**Note:** If you have send a method and afterwards changed device parameters in Device Monitor, for some devices, as valves, the method start parameters will be send and executed, if the Device Monitor is closed. That means, that a valve will switch back to the position, programmed in the valve's time table in *METHOD SETUP* of the current method. This is also applicable, if the Instrument is closed.



**Fig. 170:** Device Monitor

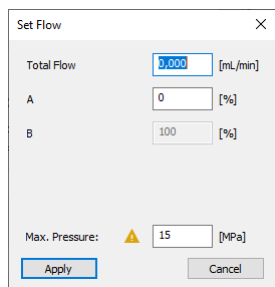
The order of instruments displayed in the device monitor can be adapted to the needs of the user easily, as shown in Fig. 171. With a right-hand mouse click on the instrument area, a menu is opened to move this segment up, down, to the top, or to the bottom.



**Fig. 171:** Moving segments of the device monitor

## 10.1 Device Monitor - Pumps

The monitor segment of the KNAUER pump includes 3 buttons which allow, like the *CONTROL* menu, input for direct control. This menu enables to shut down the system, to stop the solvent delivery and to set the flow and gradient manually. *LC CONTROL · SET FLOW...* as well as the *SET FLOW* button on the tab LC Monitor will open the window Set Flow, as shown in Fig. 172.



**Fig. 172: Direct control of the AZURA® pump P 6.1L HPG**

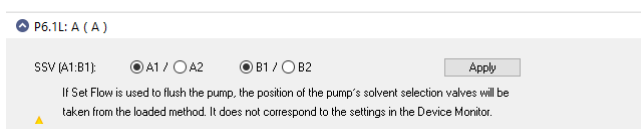
A desired flow rate and in case of a gradient system, a fixed gradient composition can be set. A maximum pressure limit also will be send. Make sure, that it fits with the pump head and the system pressure. The default Max. Pressure value can be set in *METHOD SETUP > LC GRADIENT > OPTIONS > MAX. PRESSURE FOR SET FLOW*.



**Note:** If a method with disabled solvent channel A is loaded, the „Set Flow“ does not work.



**Note:** The solvent selection valves (SSV) of the AZURA® pump P 6.1L HPG are accessible via the separate section for this pump, but not in the LC Montior section. The valve settings cannot be combined with the SET FLOW command. SET FLOW always use the SSV valve settings from the currently opened method.

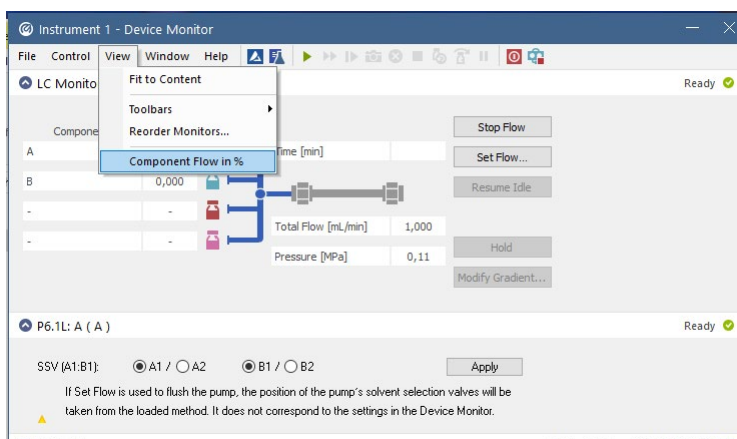


**Fig. 173: Direct Control of P 6.1L HPG SSV valves**



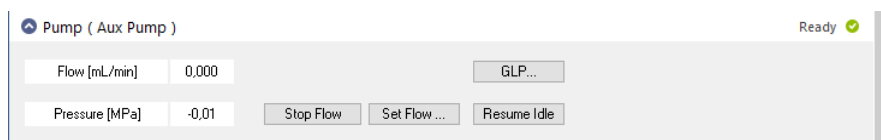
**Note:** Note that prior to starting a run (Single Acquisition), the method has to be loaded again. Otherwise the devices would run with the parameters sent by the *DIRECT CONTROL*.

The *VIEW* menu enables to select the view of gradient composition either in % or directly in ml. The state of the pump is displayed in the additional **P6.1L: A ( A )** segment. If any error is connected with the pump it will be described in this status line.

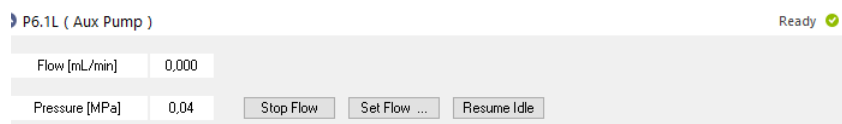


**Fig. 174: Device Monitor Pump P 6.1L HPG**

## 10.2 Device Monitor - Auxiliary pump



**Fig. 175:** Device Monitor auxiliary Pump 100



**Fig. 176:** Device Monitor Pump P 6.1L as auxiliary pump

If the AZURA® Pump P 4.1S or P 2.1S is configured as an auxiliary pump, the device monitor is different from the Device Monitor of the usual pumps. You are enabled to set a desired flow, to stop the flow, resume idle or display the GLP data

*STOP FLOW:* Stops the flow of the pump.

*SET FLOW:* Setting the flow for purging the pump. Clicking on this button opens a window, in which the wanted flow and the gradient composition can be entered, if the pump runs LPG mode.

*RESUME IDLE:* Loads the settings which are defined by the Idle mode set in the pump setup.

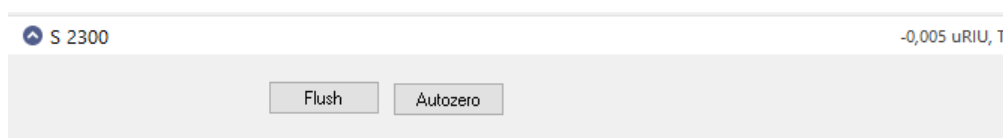
*GLP:* Display the GLP data of the pump.



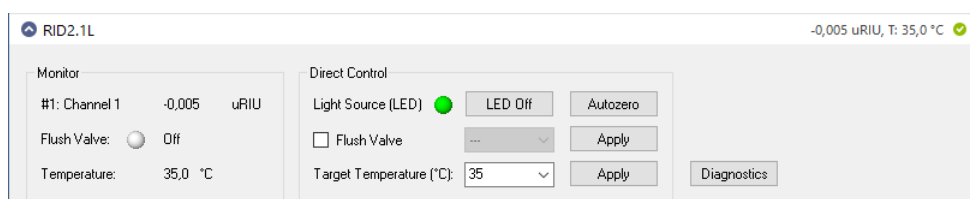
**Note:** Note that prior to starting a run (Single Acquisition), the method has to be loaded again. Otherwise the devices would run with the parameters sent by the *DIRECT CONTROL*.

## 10.3 Device Monitor - KNAUER RI detectors

The status and as far as occurring the kind of error is displayed in the headline of the instrument field. Additionally, the possibility to execute an autozero and flushing of the measurement cell is given by clicking on the appropriate buttons.



**Fig. 177:** Device Monitor RI detector



**Fig. 178:** Device Monitor RID 2.1L



## Monitor

The monitor part shows the current signal, status of the Flush valve and the temperature of the optical unit.

## Direct Control

*LIGHT SOURCE (LED):* The LED can be switched off and on again. If switched off if the RID will be switched on, it must be switched on by software after the next start of the detector. If LED is switched off, no data can be acquired.

*FLUSH VALVE:* If the check box „Flush Valve“ is enabled, you can open the flush valve by clicking the Apply button to flush reference and measurement cell. To close the valve, uncheck the check box and click again the Apply button.

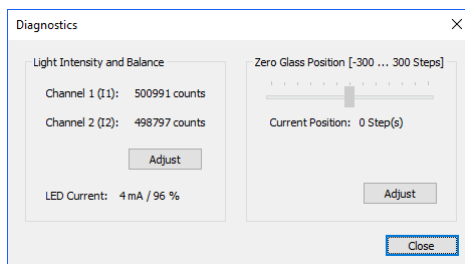
To flush for a defined time, select the time from the drop-down menu before clicking Apply. If a time is selected, the flush valve will close automatically, if the selected time is reached.

*FLUSH:* The flush valve will be switched on for the time that is configured in the instrument (not for RID 2.1L).

*TARGET TEMPERATURE:* You can set the temperature for the optical unit. If selected, click the Apply button to send the new temperature. Keep in mind, that it requires a longer time to reaches a new cell temperature. **The cell temperature can reach only up to a flow rate of 4 ml/min. If using higher flow rates, the eluents must be pre-temperated.**

*AUTOZERO:* The autozero first checks the zero glass position and adjust it, if necessary, then the electronically autozero will be done.

## Diagnostics



**Fig. 179:** Diagnostics RID 2.1L

*LIGHT INTENSITY AND BALANCE:* The detector signal is determined through the calculation formula (see RID manual) using:

Channel 1 (I1) counts measured on diode 1 and Channel 2 (I2) counts measured on diode 2. Before carrying out a measurement, both diodes must be balanced: this means roughly the same amount of light should fall on both diodes, i.e. Channel 1 and Channel 2 should have roughly the same number of counts.

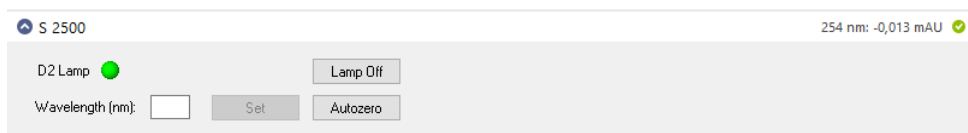
*ZERO GLASS POSITION:* Ideally before carrying out a measurement, the position of the zero glass should be roughly 0 (Extended Dynamic Range OFF). This ensures a maximum measurement range for both positive and negative peaks. The zero glass position can be recalculated via the Adjust command.

*LED CURRENT:* The actual electrical current from the light source is displayed in % and mA units. This value can be used to monitor the aging of the LED, but only when the same total number of counts is compared over time. The LED current in % value is normalized to LED power factor 1. The LED current in mA is not normalized.

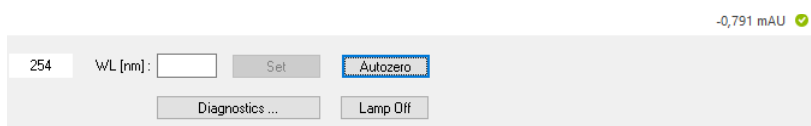
## 10.4 Device Monitor - KNAUER UV Detectors

The status and as far as occurring the kind of error is displayed in the headline of the instrument field. Additionally, the possibility to execute an autozero and to switch the lamp off or on is given by clicking on the appropriate buttons. After entering a new wavelength, the Set button is activated. Clicking the Set button sends the new settings to the detector.

Note that prior to starting a run (Single Acquisition), the method has to be loaded again. Otherwise the devices would run with the parameters sent by the *DIRECT CONTROL*.



**Fig. 180:** Device Monitor Smartline UV detector 2500

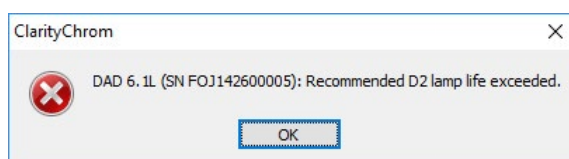


**Fig. 181:** Device Monitor UD 2.1S detector

For the functionality of the diagnostics menu, which can be accessed after clicking Diagnostics... please refer the Diagnostics section of the chapter Device Monitor - KNAUER PDA Detectors page 139.

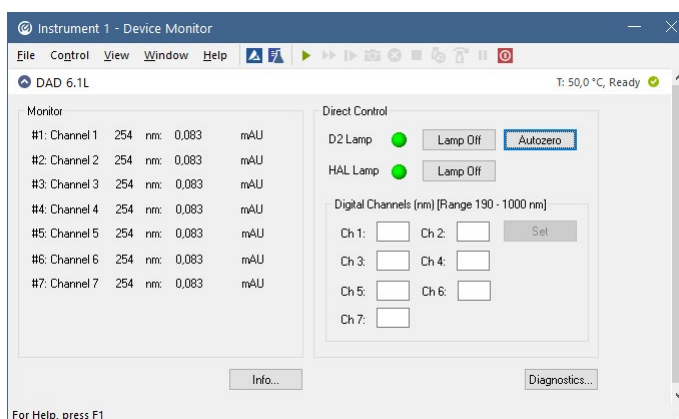
## 10.5 Device Monitor - KNAUER PDA Detectors

If the lamp time of a PDA detector has exceeded the maximum recommended life time, a warning message will be displayed every time, if the instrument is opened.

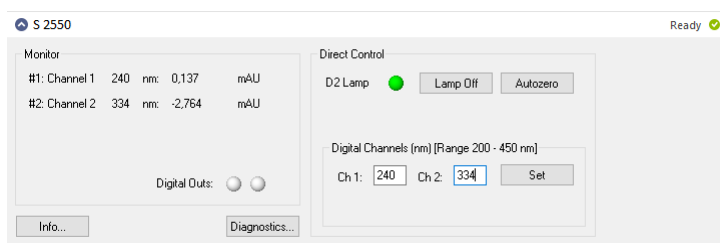


**Fig. 182:** PDA lamp life time message

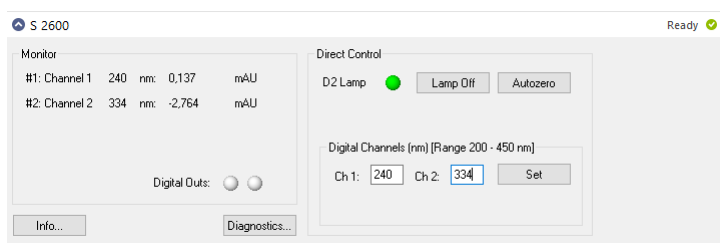
The status and as far as occurring the kind of error is displayed in the headline of the instrument field. The monitor is divided in two sections, the monitoring and the Direct Control area.



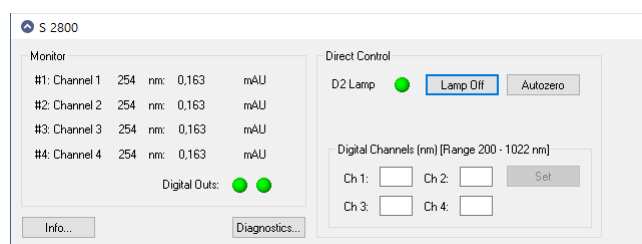
**Fig. 183:** Device Monitor - AZURA® DAD 6.1L



**Fig. 184:** Device Monitor S 2550



**Fig. 185:** Device Monitor S 2600



**Fig. 186:** Device Monitor S 2800

The set wavelength and the corresponding current signals of all configured channels are displayed. The detector signal will be displayed if a method was sent to the device. For the detector K-2600 the signal will only be displayed if a Run is performed. The current status of the two digital outs is indicated by the red (ON) or grey (OFF) LED symbol.

**Direct Control** D2 Lamp (HAL Lamp): An active green LED symbol ● indicates that the device is ON, a gray inactive LED symbol ● indicates that the device is OFF. Clicking on the *LAMP OFF* button will, after a confirmation, switch the lamp off and change the button label to *LAMP ON*. The appearance of the HAL lamp control depends on the individual detector and its configuration.

If the lamp is switched off by software, for all AZURA® L-detectors the lamp will be still in off state, if the detector is switched off and on again. You need to switch on the lamp by software before you can start to work with the detector.

*AUTOZERO*: Activate this option to perform an *AUTOZERO* and to define the current signal as base line.

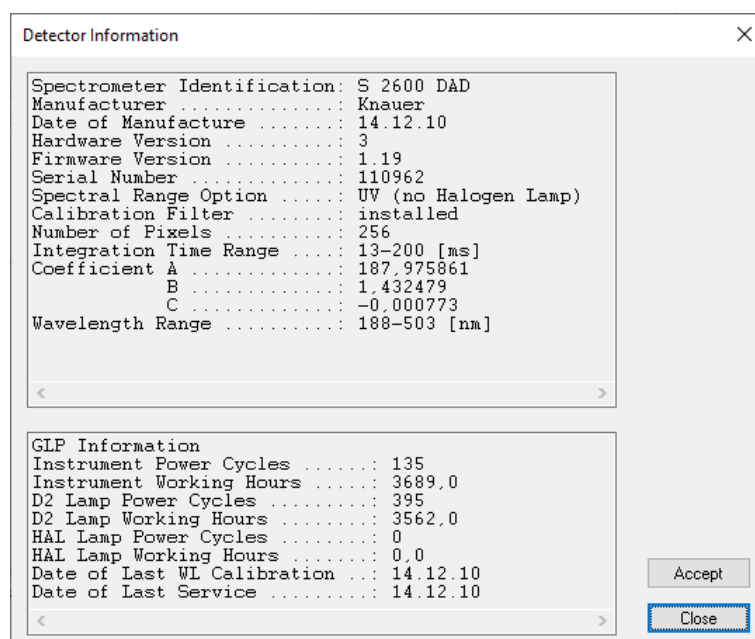
*DIGITAL CHANNELS* (nm) [Range 200 - 450 nm]: The number of channels that will be activated depends on how many possibilities are given to set new values for the measuring wavelengths. Only after a new wavelength value has been entered does the *SET* button get activated. Clicking the *SET* button sends the new settings to the detector.

*DIGITAL OUTS*: The status of digital outs is indicated. The digital outs are controlled as described in chap. 7.16.1 or during a run from the event table, see Fig. 110 on page 93.



**Note:** After power-up, allow 30 minutes for the lamp to stabilize before running samples that may require sensitive measurements. Please note that on some detectors the lamp may not be switched on automatically when the device is switched on.

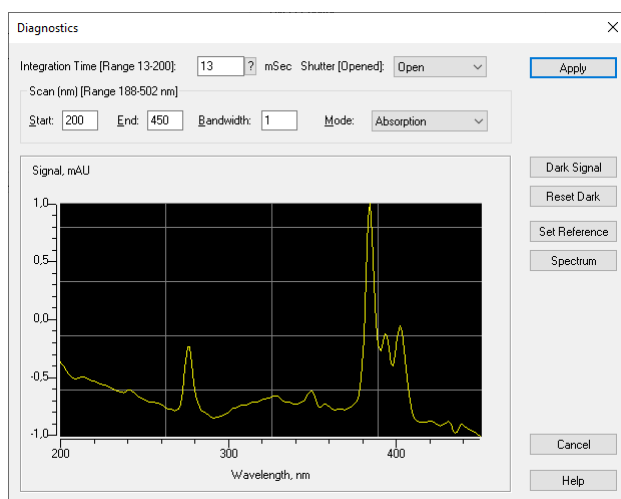
Clicking on *INFO...* opens a window with detailed spectrometer information, including the GLP relevant information.



**Fig. 187:** Spectrometer, information window S 2600

### Diagnosics KNAUER PDA Detectors

*DIAGNOSTICS*: Click on the *DIAGNOSTICS...* button to use the diagnostic features of the software. The Diagnostics window appears which allows you to access information and to control important parameters and modules of the device. The settings that are made here have no influence on the settings made in the Method Setup.



**Fig. 188:** Spectrometer, diagnostics window S 2600

**INTEGRATION TIME [RANGE 13 -200] MSEC:** The integration time is the time interval during which the detector “accumulates” light to receive one spectrum. This value is a measure of the intensity of light originating from a lamp. The more light that passes the optical scheme and the cell, the shorter the integration time will be.

The integration time depends also on the specific spectral interval (Scan) selected for the measurement, since the maximum of intensity may be varied. Click on the ? button to display the optimal integration time.

**SCAN, NM [RANGE XXX - XXX NM]:** This area is used to specify spectral parameters used for your test measurements. The range displays the minimal and maximal wavelengths available for the detector. The minimal and maximal wavelengths are the limits which are defined by the configuration of the detector.

**START, END:** *START* of Scan is the minimal wavelength to be measured. The default value is 200 nm. *END* of Scan is the maximum wavelength to be measured. The default value for the end of the range is depending on the detector.

**BANDWIDTH:** Bandwidth is the wavelength range that will be used to measure a data point of the spectrum. For the spectra acquisition, it is highly recommended to use a bandwidth of 1 nm to receive a clean spectrum.

**MODE:** Select the signal mode for your measurements from the drop-down list. The choices are *ABSORPTION* or *INTENSITY*.

**OPEN/CLOSE SHUTTER:** A click on this button will open/close the shutter. The name of the button changes accordingly.

**SET FILTER ON/OFF:** Click this button to introduce the edge filter into the light path or removes it. The name of the button changes accordingly.

**DARK SIGNAL:** Click the button to measure the dark current. This operation is enabled only for devices equipped with a shutter.

**SET REFERENCE:** Click this button to measure a spectrum to be used as a reference spectrum.

**SPECTRUM:** Click the button to measure an absorption or intensity spectrum, depending on the signal mode selected for the measurement. The measured spectrum will be shown in the spectrum view.

**AUTOCALIBRATION (S 2550, UVD 2.1L, UVD 2.1S):** The recalibration of the detector will start after clicking the Autocalibration button. It is recommended if the flow cell has been replaced by the test cell.

Please note that prior to starting a run (Single Acquisition), the method has to be reloaded. Otherwise, the devices would have to run with the parameters transmitted via *DIRECT CONTROL*.

## 10.6 Device Monitor - Virtual detector



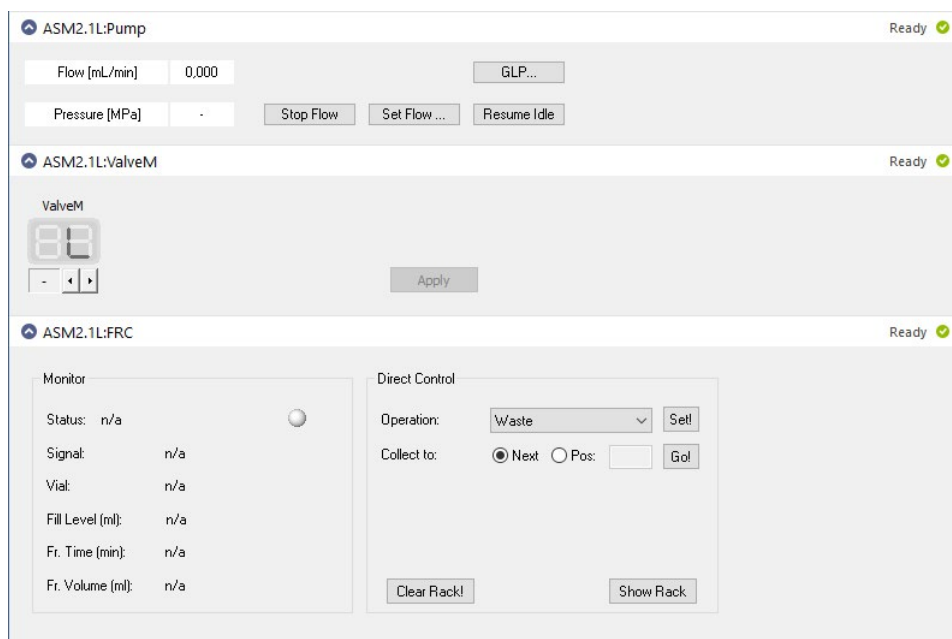
**Fig. 189:** Device Monitor - Virtual detector (VD)

The only opportunity the monitor offers is to start a trigger. This will start a run, if the system is in Waiting state.

## 10.7 Device Monitor - Assistant ASM 2.1L / ASM 2.2L

The status of the assistant modules will be shown separately. The shown information and the *DIRECT CONTROL* options correspond with the information shown for the matching single devices.

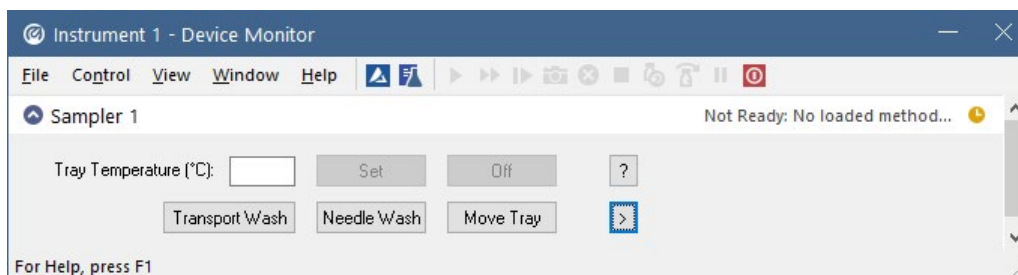
Note that prior to starting a run (Single Acquisition), the method has to be loaded again. Otherwise the devices would run with the parameters sent by the *DIRECT CONTROL*.



**Fig. 190:** Device Monitor - ASM 2.1L, pump (AUX), valve, MultiValve FC

## 10.8 Device Monitor - autosamplers

There is only one status bar for the autosamplers 3800 and 3900. The status bar for the autosamplers AS 6.1L and 3950 is depicted in Fig. 191.



**Fig. 191:** Device Monitor - autosampler AS 6.1L

The status and as far as occurring the kind of error is displayed in the headline of the instrument field.

*TRAY TEMPERATURE [°C]:* If the autosampler is equipped with a tray temperature control function, the desired temperature can be entered and sent to the device by clicking the *SET* button. Additionally, the tray thermostat can be switched On or Off and a needle wash procedure can be started.

*MOVE TRAY:* With this button the tray can be moved to the front or to the back, which simplifies loading the tray with vials. If during a run the autosamplers Analysis time is running out (refer to method setup autosampler, tab Mode, Time and Temp.), the *MOVE TRAY* button will become active. This allows for adding or removing vials during a running the sequence.

*TRANSPORT WASH:* With this button the syringe and the tubings flushed with the solvent from the transport bottle. Please refer to the manual of the autosampler.

*NEEDLE WASH AS 6.1L:* The needle wash setup window appear. Please refer to the method setup of the Autosampler AS 6.1L.

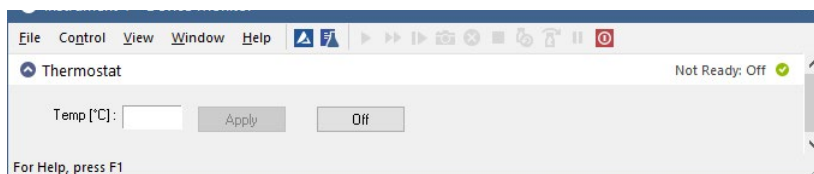
*NEEDLE WASH AS 3950:* With this button the syringe and the tubings flushed with the solvent from the wash bottle. Please refer to the manual of the autosampler or to „Needle Wash“ on page 97.

Clicking on the ? button shows a window with the instrument's serial number, name and firmware version.

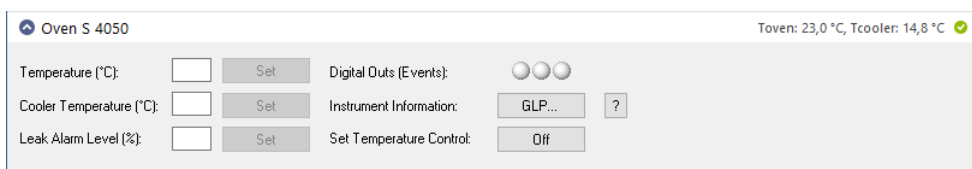
Clicking on the > button allows direct control access for the syringe, tray and injection valve. If the tray 84+3 vials tray is selected, the filling level of the transport vials 85, 86 and 87 can be set to 8000 µl by clicking the + button.

Please note that prior to starting a run (Single Acquisition), the method has to be reloaded. Otherwise, the devices would have to run with the parameters transmitted via *DIRECT CONTROL*.

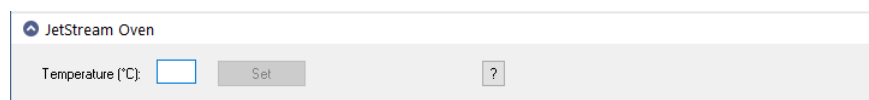
## 10.9 Device Monitor - column oven



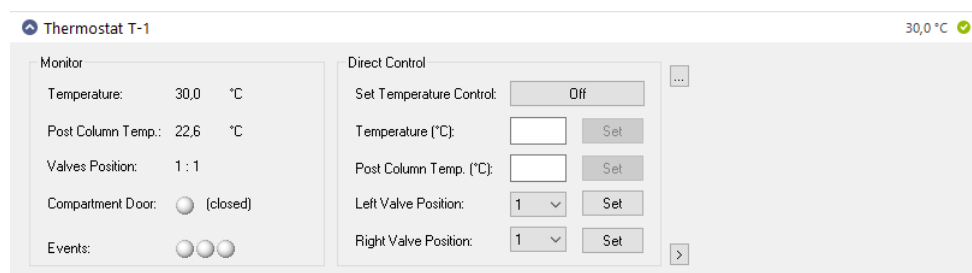
**Fig. 192:** Device Monitor - CT 2.1 Column Thermostat



**Fig. 193:** Device Monitor - Smartline Column Oven S 4050



**Fig. 194:** Device Monitor - Column Oven Jet Stream



**Fig. 195:** Device Monitor - T-1 Column Oven

### CT 2.1, S 4050, and JetStream

The status and as far as occurring the kind of error is displayed in the headline of the instrument field.

*TEMPERATURE [°C]:* The desired temperature can be entered and sent to the device by pressing the *SET* button.

*OFF:* Pressing this button, will delete the temperature settings in the thermostat. The device will not cool or heat until a new temperature has been set.

*COOLER TEMPERATURE [°C](S 4050 only):* The desired cooler temperature can be entered and sent to the device by pressing the *SET* button.

*LEAKAGE ALARM LEVEL (%) (S 4050 only):* The desired sensitivity of the leakage sensor can be entered and sent to the device by pressing the *Set* button.

*EVENTS / DIGITAL OUTS (EVENTS) (S 4050 only):* The status of digital outs is indicated. The digital outs are used as described on page 86 and can be changed during a run from the event table (Fig. 110 on page 93).



*INSTRUMENT INFORMATION* (S 4050 only): Clicking on the *GLP...* button opens a window with the current GLP information. *SET TEMPERATURE CONTROL* (S 4050 only): The temperature control can be switched On or Off.

Clicking on the ? button opens a window with general device information.



**Note:** If an error message is displayed for the CT2.1, send a new temperature to reset the error message in the thermostat.

## T-1

The status and as far as occurring the kind of error is displayed in the headline of the instrument field. The monitor is divided in two sections, the monitoring and the *DIRECT CONTROL* area. The *DIRECT CONTROL* area allows entering and executing parameters independent of which method parameters are currently set. Please note that prior to starting a run (Single Acquisition), the method has to be reloaded. Otherwise, the devices would have to run with the parameters transmitted via *DIRECT CONTROL*.

**Monitor** *TEMPERATURE:* Shows the current temperature on the thermostat.

*POST COLUMN TEMP:* Shows the current temperature on the post column cooler.

*VALVE POSITION:* Shows the current position of the valves.

*COMPARTMENT DOOR:* Shows if the door of the thermostat is closed or open.

*EVENTS:* Shows the status of the digital outputs. A red display indicates ON and a red display indicates OFF.

**Direct Control** *SET TEMPERATURE CONTROL:* With this button, the temperature control for the thermostat can be switched On or Off. The name of the button indicates what happens if the button is clicked. If the button shows Off, switch off the temperature control with a mouse-click and vice versa. Consequently, the status of the temperature control is the opposite of what the button reads.

*TEMPERATURE [°C]:* The desired temperature can be entered and sent to the device by pressing the *SET* button.

*POST COLUMN TEMP. [°C]:* The desired temperature can be entered and sent to the device by pressing the *Set* button.

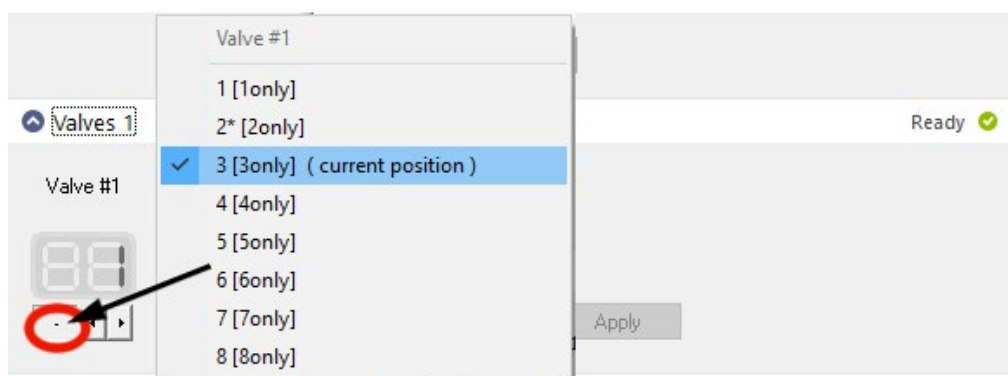
*LEFT VALVE POSITION/RIGHT VALVE POSITION:* The valve position can be changed. If the option Column Switching Option has been activated in the configuration dialog, only the position of the left valve can be changed. The right valve automatically switches its position to the position of the left valve. By clicking *SET*, the input is sent to the device.

*...:* Shows the GLP data of the columns. The columns have to have a KNAUER RFID chip and have to be connected to the thermostat accordingly.

*>:* Allows entering the Column Storage Conditions (max. 19 characters) and a user name (max. 11 characters). The columns have to have a KNAUER RFID chip and have to be connected to the thermostat accordingly.

Please note that prior to starting a run (Single Acquisition), the method has to be reloaded. Otherwise, the devices would have to run with the parameters transmitted via *DIRECT CONTROL*.

## 10.10 Device Monitor - KNAUER Switching Valves



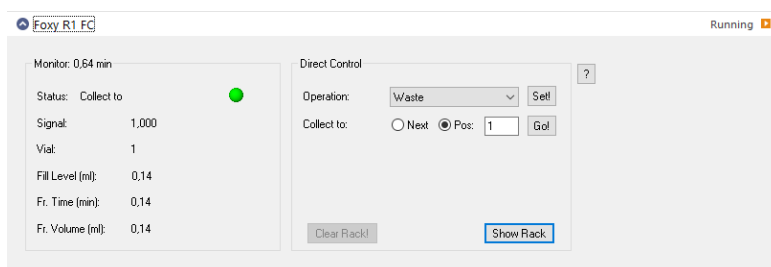
**Fig. 196:** Device Monitor for KNAUER switching valves

On top the valve name and the position name (both named in configuration) is shown. If an event has been activated for the position, it is represented by a \* (VU 4.1 only).

The current position for each valve is displayed in the Position row. To change this, you can enter the positions directly or select the positions with the  button. The choices depend on the configured valve. The *BLANK* (-) space means that the valve will not change its position after clicking the *APPLY* button. If you make a left mouse click on the valve position, a menu will open to select the desired position directly. If for any reason the communication to a valve is interrupted, the corresponding field for the valve position is grayed and no position number will be shown.

Please note that prior to starting a run (Single Acquisition), the method has to be reloaded. Otherwise, the devices would have to run with the parameters transmitted via *DIRECT CONTROL*.

## 10.11 Device Monitor - fraction collectors



**Fig. 197:** Device monitor for the FC 3050

The status and as far as occurring the kind of error is displayed in the headline of the instrument field. The monitor is divided in two sections, the monitoring and the *DIRECT CONTROL* area. The appearance of the window may slightly depend on the type of fraction collector in use.

**Monitor** *STATUS*: The current operation is displayed. It is additionally indicated by the LED color (waste ? gray , fraction ? green , or solvent recycling ? blue )

*SIGNAL*: The current value of the controlling detector channel is displayed.

*VIAL*: The current fraction vial number is displayed.

*FILL LEVEL*: The filling level of the current vial is shown in ml. It may differ from the fraction volume if consecutive runs are collected to the same vial positions.

*FR. TIME*: The collection time for the current fraction is displayed.

*FR. VOLUME*: The collected volume of the current fraction is displayed.

*DIRECT CONTROL*: In the direct control mode some operations or selections are possible.

*OPERATION*: The operation which shall be performed can be selected from the drop-down list. The choices are: *WASTE* and *SOLVENT RECYCLING*. Clicking the *SET!* button starts the selected operation.

*COLLECT TO*: The operation fraction collection can be initiated here. The next free vial can be selected with *NEXT* or a vial position can be defined with *POS*: as the destination to where to collect to. The collection starts by clicking on the *GO!* button.

Pressing the question mark '?' Plug the cable plug button opens a window with general device information.



**Note:** The current operation Collect, Recycling or Waste depends on the last click on either the Set! or Go! button.

All operations started in the direct control mode are performed unconditioned as timed events. For consecutive conditioned runs the values for level, slope and the expected interval will not be stored.

*CLEAR RACK*: Click the *CLEAR RACK* button to clear the occupied positions in the rack.



**Note:** Clear Rack will delete all information of collected fraction from the rack. Make sure that all vials have been emptied to prevent, that they will be overfilled or different fractions will be mixed in a vial.

*SHOW RACK*: Click the *SHOW RACK* button to display the rack.

The type of rack displayed corresponds to the configured one. The shape of the rack view for the Multi valve fraction collector also depends on the configured valves. If different valves are combined the graphical separation may not be shown. The number of displayed positions also may exceed the current existing number of collection positions, due to the rectangular arrangement.

Vial Table							
Vial 6: 4.17-4.47 min, 2.35 ml							
1	12	13	24	25	36	37	48
2	11	14	23	26	35	38	47
3	10	15	22	27	34	39	46
4	9	16	21	28	33	40	45
5	8	17	20	29	32	41	44
6	7	18	19	30	31	42	43

**Fig. 198: Fraction Collector vial table**



**Note:** In case of MultiValve Fraction Collector the shown vial position may not be correct, due to the rectangular arrangement.

All already used vials will appear highlighted green. Moving the cursor across the rack will change the upper descriptive line. The vial number, the start and the end of the collection and the collected volume are displayed.

If only one fraction is collected on this position, the following is displayed: *VIAL 1: 0.37-1.32 MIN, 0.95 ML* is displayed while the time is not displayed during a cumulative collection into a vial and the volume equals the cumulative value. *VIAL 1: 1.24 ML [MULTIPLE FRACTIONS]*.

A mouse double-click on a vial during a run will force collection of the eluate into that vial (Direct Control operation). Mouse double-click on the vial where the fraction is being collected during a run will force the eluate to be directed to waste.

Mouse double-click with pressed control (<Ctrl>) key on a vial with a collected fraction when it is not running will force the corresponding chromatogram to be opened.

Note that prior to starting a run (Single Acquisition), the method has to be loaded again. Otherwise the devices would run with the parameters sent by the *DIRECT CONTROL*.

Science Together



Latest KNAUER instructions online:  
[www.knauer.net/library](http://www.knauer.net/library)

**KNAUER**  
Wissenschaftliche Geräte GmbH  
Hegauer Weg 38  
14163 Berlin

Phone: +49 30 809727-0  
Fax: +49 30 8015010  
E-Mail: [info@knauer.net](mailto:info@knauer.net)  
Internet: [www.knauer.net](http://www.knauer.net)