

PurityChrom®

Version 5.9.1xx
Software instructions

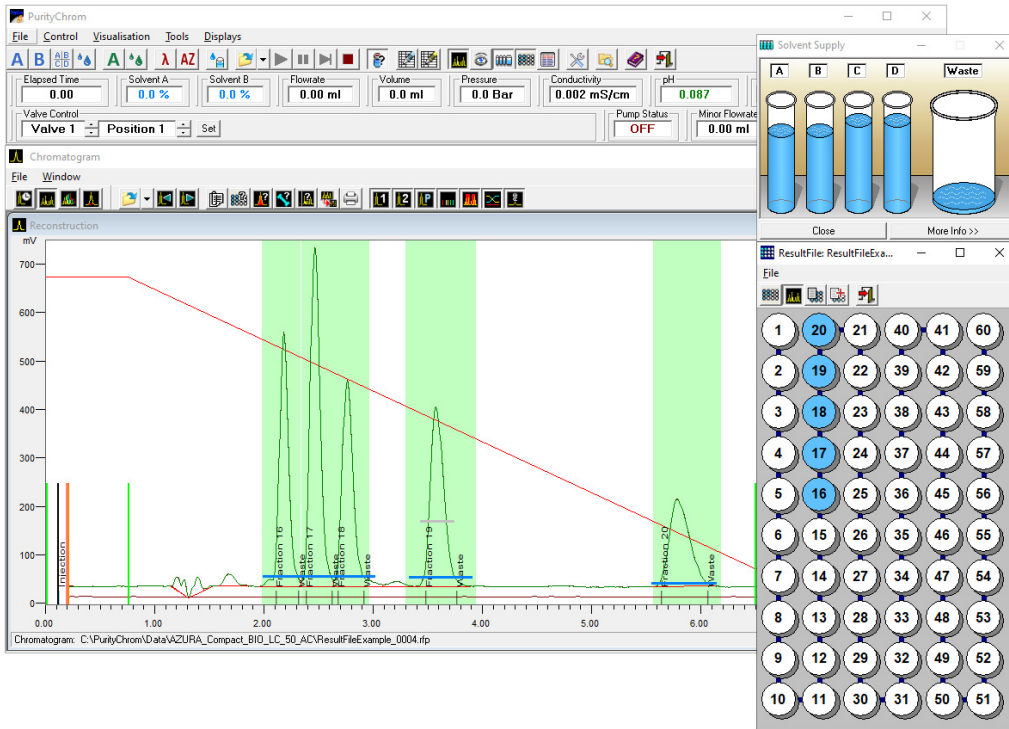



Note: For your own safety, read the instructions and observe the warnings and safety information on the device and in the instructions. Keep the instructions for future reference.



Note: In case you require this instruction in another language, please submit your request including the corresponding document number via e-mail or fax to KNAUER.

Support: Do you have questions about the installation or the operation of your instrument or software?

International Support:

Contact your local KNAUER partner for support:

www.knauer.net/en/Support/Distributors-worldwide

Support in Germany

(Austria & Switzerland on case-to-case basis):

Phone: +49 30 809727-111 (workdays 9-17h CET)

Fax : +49 30 8015010

Email: support@knauer.net

Publisher: KNAUER Wissenschaftliche Geräte GmbH

Hegauer Weg 38

14163 Berlin

Germany

Phone: +49 30 809727-0

Fax: +49 30 8015010

Internet: www.knauer.net

E-Mail: info@knauer.net

Version information: Document number: V2650

Version number: 5.0

Release date: 2021/02/04

Translation of the original edition

The information in this document is subject to change without prior notice. For the latest version of the instructions, visit our website: www.knauer.net/library.



Sustainability: The printed versions of our instructions are printed according to Blue Angel standards (www.blauer-engel.de/en/uz195).

Copyright: This document contains confidential information and may not be reproduced without written consent of KNAUER Wissenschaftliche Geräte GmbH.

© KNAUER Wissenschaftliche Geräte GmbH 2021
All rights reserved.

Table of Contents

1. Product information	1
1.1 Intended use	1
1.2 Supported instruments	2
2. Installation	3
2.1 PC requirements	3
2.2 Language selection	3
2.3 Installation and use under Windows	3
2.4 Energy saving features	4
3. Main window	5
3.1 General	5
3.2 Function buttons	6
3.3 Displays	10
4. Program settings (setup)	12
4.1 Communication	12
4.2 Presets	13
4.3 Fraction limiter	14
4.4 Annotation	15
4.5 Descriptions	16
4.6 User defined channel	17
4.7 Dead time / dead volume	18
4.8 Valve locking	19
4.9 Alarm outputs	19
4.10 Program colors	20
5. User administration	21
5.1 General	21
5.2 Working without user administration	21
5.3 How to activate the user administration	21
5.4 Adding a user	22
5.5 Resetting a password	23
5.6 Resetting failed attempts	23
5.7 User login	24

5.8	Locked account	25
5.9	Printing the user administration.....	25
5.10	Function buttons in the audit trail window.....	25
6.	Creating time control files	26
6.1	General	26
6.2	Creating a time control file.....	28
6.2.1	Storing of general information	29
6.2.2	Creation of a checklist.....	30
6.2.3	Variables in time tables.....	31
6.2.4	Optional settings	32
6.2.5	Printout options	33
6.2.6	Settings for diode array detectors	33
6.2.7	Time control file commands	34
6.3	Using the AZURA® pump P 6.1L (high pressure gradient version)	38
6.4	Fractionating with a fraction collector	38
6.5	Fractionating with a multiposition valve.....	38
6.6	Programming thresholds	40
6.7	Programming threshold with logic gates.....	42
6.8	Programming peak sampling.....	44
6.9	Graphic time control file editor	46
7.	Creating sequence tables	49
7.1	General	49
7.2	Creating a sequence table.....	49
7.3	Execution of a sequence table.....	50
8.	Creating autosampler control files.....	52
8.1	General	52
8.2	Creating an autosampler control file	55
8.3	Stacked injection	57
8.4	Creating a sample identifier table.....	59
9.	Control file visualisation	61
10.	Data recording (analysis)	62
10.1	General	62
10.2	Function buttons	63
10.3	Status bar.....	64

10.4	Data channel settings	65
11.	Displaying chromatograms (reconstruction)	68
11.1	General	68
11.2	Function buttons	69
12.	Comparing chromatograms (compare)	72
12.1	General	72
12.2	Function buttons	73
13.	Reintegrating chromatograms	74
13.1	General	74
13.2	Function buttons	75
14.	System visualisation	78
14.1	General	78
14.2	System visualisation functions	79
14.3	Creating a system visualisation	79
15.	Displaying the solvent supply	82
15.1	General	82
15.2	Solvent visualisation	82
15.3	Solvent supply display settings	83
16.	Waste management	84
16.1	General	84
16.2	Display	84
16.3	How to use the waste management	84
17.	Rack display of fraction collector (fraction rack)	85
17.1	General	85
17.2	Fraction collector rack functions	86
17.3	Fraction table	87
17.4	Fraction rack setup	88
18.	RID 2.1L setup	90
19.	Control of mass spectrometers	92
19.1	General	92
19.2	Control of the 4000 MiD / MIDAS Spectrometer	92
19.2.1	Function buttons	92

19.2.2	Displays	93
	Status displays	94
19.2.3	4000 MiD / MIDAS setup	94
	Midas setup	94
	Spectrometer setup	95
	Mass spectrometer parameters in the time control file	95
20.	Control of heating devices	97
20.1	CT 2.1	97
20.2	Memmert UN 55 Oven	97
21.	Event box	98
21.1	Manual control of the event box	98
21.1.1	Eventbox Input	98
21.1.2	Eventbox Output	99
22.	Troubleshooting	100
22.1	Error message lamp lifetime	100
22.2	Communication Error: Interface sends an error	100
23.	Appendix	103
23.1	The entries in the file PurityChrom.ini	103
23.2	PurityChromfile types	117
23.3	Combination of autosampler tray types	117

1. Product information

1.1 Intended use

PurityChrom® is a chromatography data and control software especially designed for the area of biochromatography application. Its superior flexibility and modular construction mean that the program can be adapted to suit any user's system. PurityChrom has the added advantages of a clearly structured interface and an user friendly method construction.

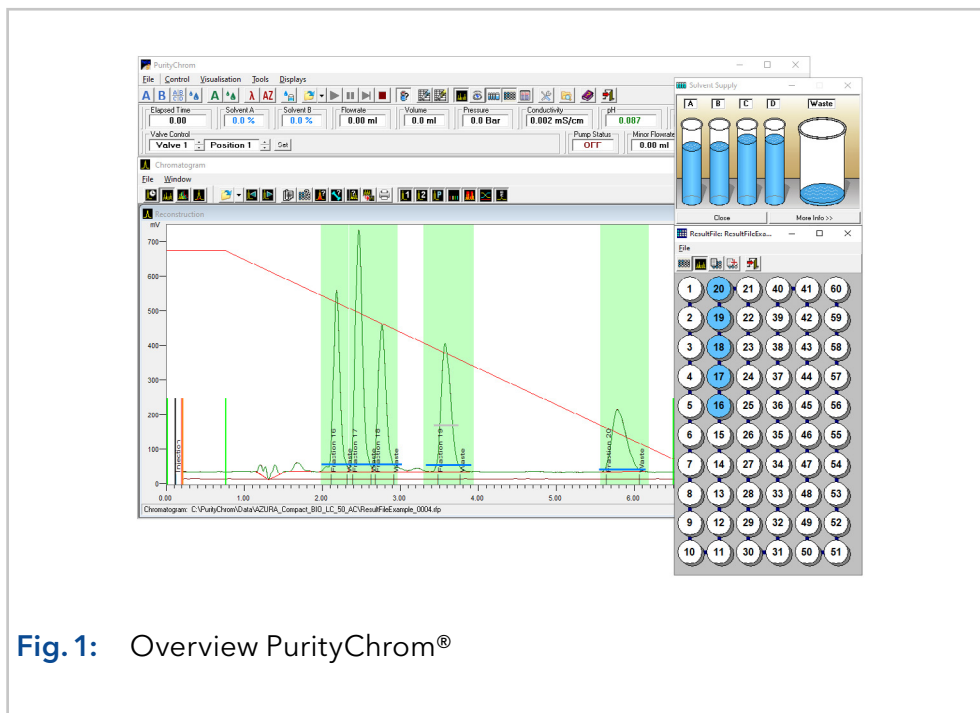

Fig. 1: Overview PurityChrom®

The program allows isocratic elution of up to four solvents, gradient programming and gradient support. Switching valves and fraction collectors can be controlled by time, threshold values or automatic peak sampling. Time table control files can be programmed in units of time, units of volume of the solvent supported or in units of column volume.

The entire run is displayed in a visualisation diagram of the system which can be individually formatted, and in a time control file which indicates the stage in progress at all times.

The display settings and function buttons in the main window can be personalized by the user.

The screen buttons allow manual control of the pumps, the detector and the valves.

The system visualization and the graphic time control editor provide graphical representation and easy handling of the complex flow processes. Furthermore, each device which is displayed in the fluidic scheme can be manually controlled giving the opportunity to optimize and change, and adapt your conditions spontaneously during the run.

Additionally, there is also a possibility to pause the method during the run due to the hold function providing you with complete control over your chromatography process.

Solvent visualization calculates the consumption of solvent for the current run and prevents your column from running dry whereas waste management prevents the loss of your sample.

The results data from a run includes all the chromatograms recorded, with integration results, the time control tables, the autosampler table, a protocol of the entire run and a fraction table with links to the fraction rack and the appropriate chromatograms. Thus PurityChrom allows the user to re-establish all the relevant information needed to reproduce the run from the results data alone.

1.2 Supported instruments

For an overview of supported instruments by PurityChrom, please refer to the following list: www.knauer.net/softwarecontrol.

2. Installation

2.1 PC requirements

Requirements	
Operating Systems	Windows XP, Windows Vista, Windows 7, Windows 8, Windows 10 Only English and German as operating system languages are tested and supported.
CPU/Memory	Pentium III or higher with at least 1 GHz at least 512 MB RAM (Windows XP) and 2 GB (Windows Vista and higher)
Network	Second network card is required for network integration.
Graphics	Screen with minimal resolution 1024 x 768
Connectors and Slots	USB for license dongle COM, USB or LAN according to connected instruments

2.2 Language selection

PurityChrom is available in English and German. Some Error messages and notifications may be displayed in English regardless of the language selection.

2.3 Installation and use under Windows

Installation of PurityChrom in directories under C:\Windows\Program Files (or C:\Windows\Programme) is NOT recommended as write access may be limited by the windows user administration in these directories. Please use installation paths like C:\PurityChrom or D:\PurityChrom.

Administrator rights are necessary during installation of PurityChrom and the Windows User Account Control settings should be set to "Never notify" in order to deactivate the User Account Control. It may be re-activated after the installation.

The user needs write and read permission for registry and folders C:\Windows, C:\Puritychrom.

PurityChrom needs to be excluded from Microsoft Security Essentials. Furthermore, the Windows Defender and antivirus software should be deactivated.

If Windows 8 or 0 is used, it is recommended to run installation setup as administrator, than open the PurityChrom program folder „C:\PurityChrom\", use a rightclick on „PurityChrom.exe“ and select once „Run as administrator“, open the „Communication Log“-Window and the "System Visualisation" once. Then close the software.

If you use an older Windows version go to C:\PurityChrom and right-click the PurityChrom.exe to open the properties. Go to compatibility and check "Run this program in compatibility mode for" and choose "Windows Vista (Service Pack 2). After this, check "Run this program as an administrator". Click "Apply" and "Ok", than close the window.

2.4 Energy saving features

Automatic switching to energy saving mode or hibernating has to be disabled i.e. settings for "Turn Off Hardware", "Turn off Computer" or "System Standby" must be set to "Never" in the control panels energy options.

3. Main window

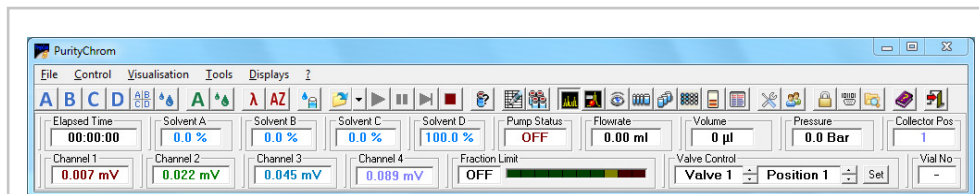

Fig. 2: Main window

3.1 General

The main window is made up of a toolbar with function buttons, plus a display bar in which the current system data is displayed. The arrangement of the function buttons and displays can be personalized by the user. The size and position of the window can also be changed, and will be saved when the program is closed.

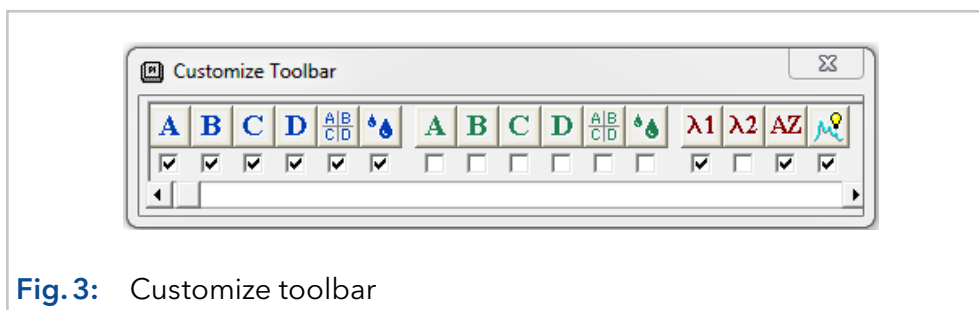

Fig. 3: Customize toolbar

To make changes to the toolbar, double-click on an empty space on the toolbar. The *CUSTOMIZE TOOLBAR* will open, where you can add and remove buttons. To hide a button, deselect the checkbox under it. The settings will be saved when you exit the program.

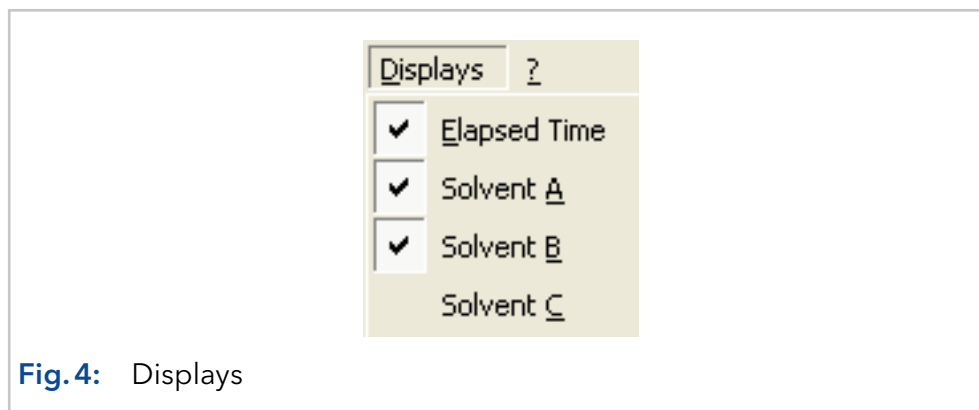

Fig. 4: Displays

To add or remove displays, select the relevant display from the *DISPLAYS* menu. The selected displays will be ticked in the menu. To change the display colour, right-click on a display and select the menu option *EDIT DISPLAY COLOUR*. The colour dialogue that appears will allow you to choose a new colour.

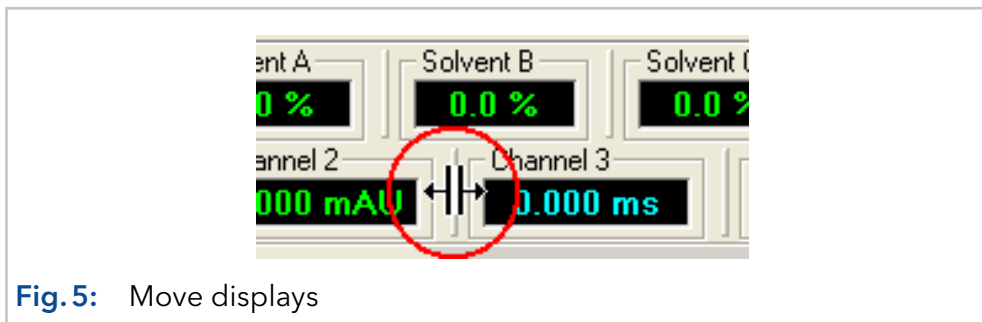































Fig. 5: Move displays













To move displays, click on the vertical line in front of the display and drag it to its new position. If you drag a display down and out of the window, a new display bar will appear. The arrangement of the toolbar and display bar is saved when you exit the program and will reappear this way the next time you open it.

3.2 Function buttons









Button	Meaning
	<i>100% SOLVENT A MAJOR PUMP</i> starts the Major Pump System with 100% eluent A and the currently set flow rate.
	<i>100% SOLVENT B MAJOR PUMP</i> starts the Major Pump System with 100% eluent B and the currently set flow rate.
	<i>100% SOLVENT C MAJOR PUMP</i> starts the Major Pump System with 100% eluent C and the currently set flow rate.
	<i>100% SOLVENT D MAJOR PUMP</i> starts the Major Pump System with 100% eluent D and the currently set flow rate.
	<i>SOLVENT COMPOSITION MAJOR PUMP</i> starts the Major Pump System with the solvent composition shown in the Solvent Composition window and the currently set flow rate.
	<i>FLOW RATE MAJOR PUMP</i> opens a window to show the flow rate. A change to the flow rate does not start the pumps, but it will take immediate effect if the pumps are running.
	<i>100% SOLVENT A MINOR PUMP</i> starts the Minor Pump System with 100% eluent A and the currently set flow rate.
	<i>100% SOLVENT B MINOR PUMP</i> starts the Minor Pump System with 100% eluent B and the currently set flow rate.





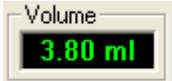
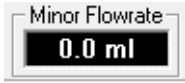

Button	Meaning
	<i>100% SOLVENT C MINOR PUMP</i> starts the Minor Pump System with 100% eluent C and the currently set flow rate.
	<i>100% SOLVENT D MINOR PUMP</i> starts the Minor Pump System with 100% eluent D and the currently set flow rate.
	<i>SOLVENT COMPOSITION MINOR PUMP</i> starts the Minor Pump System with the solvent composition shown in the Solvent Composition window and the currently set flow rate.
	<i>FLOW RATE MINOR PUMP</i> opens a window to show the flow rate. A change to the flow rate does not start the pumps, but it will take immediate effect if the pumps are running.
	<i>WAVELENGTH</i> opens a window where you can enter the wavelength of your controlled UV detector, the UV lamp can be turned on/off and the detector can be calibrated/validated. Using a DAD you cannot choose the wavelength here, but in the Time Control File (see "Settings for Diode array Detectors") or chromatogram view (Analysis Window).
	<i>AUTOZERO</i> will return a serial controlled detector to zero. Note: If a leak is detected at the UV detector (DAD / MWD) please take care of the leakage and reset the error by pressing autozero.
	<i>SET REFERENCE SPECTRUM</i> sets the current DAD spectrum as reference spectrum.
	<i>TEMPERATURE SETTING</i> can be used to set the temperature of an RID, eluent heater or oven.
	<i>LIMITER VALUE</i> opens a window where you can enter the maximum value for the fraction limiter.
	<i>LOAD TIME CONTROL FILE OR AUTOSAMPLER CONTROL FILE</i> opens a data file selection window where you can load a time control file or autosampler control file. In the file type box of this window, you can select either *.tcf (Time Control File) or *.acf (Autosampler Control File). If the option Start Pumps after loading Time Control File is selected in the time control file, the pumps will begin once loading is complete, with the solvent composition and flow rate programmed for time point 0.00 minutes.

Button	Meaning
	<i>START TIME CONTROL FILE OR AUTOSAMPLER CONTROL FILE</i> starts the time control file or autosampler control file that has been loaded. If the function Hold Time Control File or Autosampler Control File was executed first, the run will resume.
	<i>HOLD TIME CONTROL FILE OR AUTOSAMPLER CONTROL FILE</i> pauses the time flow of a time control file or autosampler table. If the option Stop Pumps at Time Control Hold is selected in the time control file, the pumps will have a flow rate of 0 ml. While the Hold function is activated, the flow rate of the pumps can be adjusted manually using the Flow rate function. Start Time Control File or Autosampler Control File resumes the run at the time point where it was paused.
	<i>JUMP TO NEXT TIME CONTROL LINE</i> jumps forward in time to the next line programmed in the time control table. The first time you use this function, you must confirm it in a dialogue box, but it is possible here to select the option Don't ask again, to avoid seeing this box in future.
	<i>STOP ALL</i> stops the pumps and the time control file from running. It is not possible to resume the run at the point where it was stopped.
	<i>MANUAL SAMPLE ID</i> enables you to enter a sample identifier when starting a time control file. This option is not possible when running an autosampler control file, because the sample identifiers are derived from the accompanying sample identifier file.
	<i>CREATE / EDIT TIME CONTROL FILE</i> opens the time control file editor to create or edit a time control file.
	<i>CREATE/EDIT SEQUENCE TABLE</i> opens and controls the sequence table. For detailed instructions see „6. Creating time control files“ on page 26.
	Create / Edit Autosampler Control File opens the autosampler control file editor to create or edit an autosampler control file.
	<i>CHROMATOGRAM</i> opens the chromatogram window to show the analysis, compare, reconstruction and reintegration windows.
	<i>PEAK DETECTION</i> opens the window with the automatic peak sampling displays.
	<i>SYSTEM VISUALISATION</i> opens the system visualisation window.

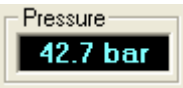
Button	Meaning
	<i>SOLVENT SUPPLY</i> opens the window with the solvent supply display.
	<i>WASTE MANAGEMENT</i> opens the window with the waste management display.
	<i>FRACTION RACK</i> opens the window with the fraction rack visualisation.
	<i>EVENT BOX CONTROL</i> opens the window with the visualisation and manual control of the event box.
	<i>CONTROL VISUALISATION</i> opens the window with the visualisations of the time control file and autosampler control file in table form.
	<i>SETUP</i> opens the setup window, in which communication settings, device parameters and device descriptions etc. can be set.
	<i>USER ADMINISTRATION</i> opens the user administration window.
	<i>KEYLOCK</i> makes it possible for you to lock the program. After activation, a <i>KEYLOCK DEACTIVATION</i> window appears on the task bar, which will unlock the program when you enter the user password. The initial password following installation is SCPA.
	<i>SERIAL COMMUNICATION</i> opens a terminal window showing the serial communication, in which you can make entries in linked interfaces.
	<i>OPEN CURRENT WORKING FOLDER</i> opens an Windows Explorer Window showing the content of the current working folder.
	<i>ONLINE HELP</i> opens the program's online help. For further help use the manual.
	<i>EXIT</i> ends the program.

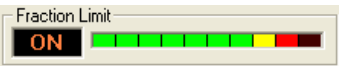
3.3 Displays

Display	Meaning
	<p><i>ELAPSED VOLUME / ELAPSED COLUMN VOLUME</i> shows the time or volume that has elapsed in a time control file. If the time control file is on <i>HOLD</i>, then the display will flash between the elapsed time and hold. During the injection phase, the display flashes between the elapsed time and <i>INJECTION</i>. Following the time control file command <i>WAIT FOR INPUT</i>, the display will flash between the elapsed time and <i>WAITING</i>.</p>
	<p><i>SOLVENT A</i> shows the current percentage of eluent A being pumped.</p>
	<p><i>SOLVENT B</i> shows the current percentage of eluent B being pumped.</p>
	<p><i>SOLVENT C</i> shows the current percentage of eluent C being pumped.</p>
	<p><i>SOLVENT D</i> shows the current percentage of eluent D being pumped.</p>
	<p><i>PUMP STATUS</i> shows the current pump status. <i>ON</i> = pump is running, <i>OFF</i> = pump has been stopped, <i>OVER</i> = pump has stopped because the pressure was too high, <i>UNDER</i> = pump has stopped because the pressure was too low.</p>
	<p><i>FLOW RATE</i> shows the pump's current flow rate.</p>
	<p><i>VOLUME</i> indicates the volume pumped through since pumping began. When the pump is stopped, the volume display returns to 0. Depending on the volume pumped, the display unit changes automatically from μl through ml to l.</p>
	<p><i>MINOR FLOWRATE</i> shows the minor pumps current flow rate.</p>
	<p><i>MINOR PRESSURE</i> indicates the current pressure of the minor pump.</p>

Display	Meaning
	<p><i>PRESSURE</i> indicates the current pump pressure. You can change the display value in Setup, under <i>PRESETS</i>, using an offset and a factor.</p>
	<p><i>COLLECTOR POS</i> shows the current fraction collector position.</p>
	<p><i>FRACTION LIMIT</i> indicates the fraction limiter status. <i>OFF</i> = limiter is inactive, <i>ON</i> = limiter is active. The LED band display indicates the volume pumped of the current fraction in steps of 10%. When the last red LED has lit up (100%), the limiter triggers a step in the fraction collector.</p>
	<p><i>VALVE CONTROL</i> shows the current position of the selected valve and is also a way of switching the valve manually. To do this, select the desired valve and the required position, and use the <i>SET</i> button to change the position.</p>
	<p><i>VIAL NO</i> indicates the current vial number of the current autosampler injection.</p>
	<p><i>RUN NO</i> shows the number of the current run in association with the function <i>RESTART</i>.</p>
	<p><i>CHANNEL 1 - CHANNEL ...</i> show the values of the device connected to each analogue entry. In the analysis window, under <i>CHANNEL SETUP</i> you can change the displays for each device using an offset, a factor and a dimension.</p>

4. Program settings (setup)

The function button or the menu option *SETUP*  in the main window opens the program settings window. In the *FILE* menu you have the possibility to save your configuration. The window contains eight tabs, whose content is described below.

4.1 Communication

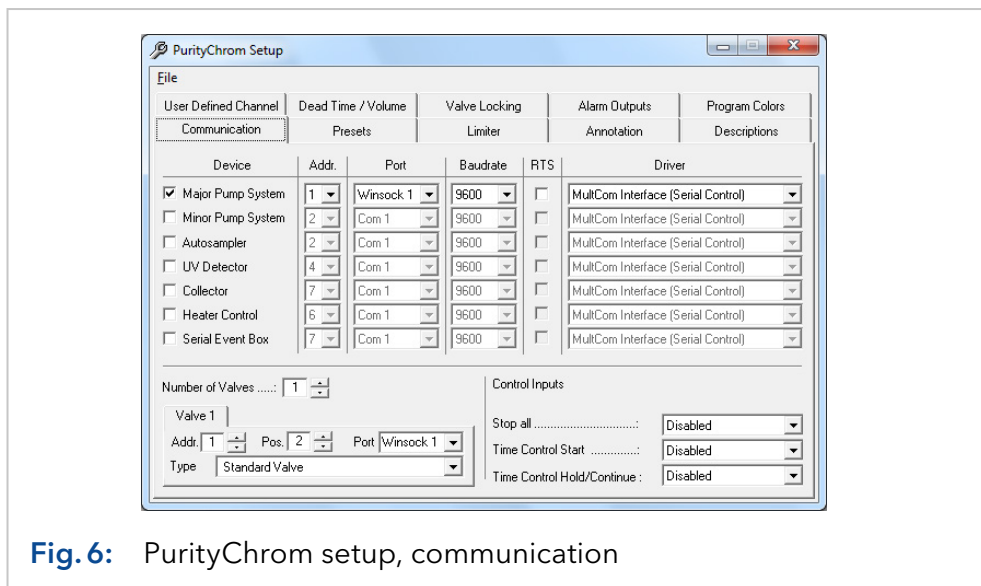

Fig. 6: PurityChrom setup, communication

The Communication setup tab is used to configure your system's serial and LAN control interfaces and valves. The basic license includes a maximum number of eight devices which are connected via LAN (Local Area Network) or RS-232 and no automatic injection. Every module in an assistant counts as one device. The full license has no limitations in the maximum number of devices and an autosampler is included.

ADDR.: In *ADDRESS* you can set the serial or LAN address which is set for the MultiCom interfaces with the help of the round encoding switch.



Note: Do not change the address.

PORT: In *PORT* you can choose the serial port or *WINSOCK* port to which each interface is connected.

DRIVER: In *DRIVER* you can choose your driver for your connected interface. You are not allowed to choose your UV detector here, as it is automatically configured during installation of PurityChrom. You can configure your system's valves at the bottom of the page.

NUMBER OF VALVES allows you to enter the number of valves. Each valve then appears on its own tab, where you can select the serial or LAN address, the number of positions and the port for this valve.

- Using a fraction collector you have to configure the valve of the collector separately (Addr.: 1, Pos.: 2, Port: Driver 5, Type: Standard Valve).
- Using the P6.1L (high pressure gradient version) as major pump, you have to configure the solvent selection valve separately by choosing two standard valves (Addr.:1 and 2, Pos.: 2, Port: Driver1).

The first valve can switch between A1 (position 1) and A2 (position 2) and the second between B1 (position 1) and B2 (position 2).

- Using the P 6.1L (high pressure gradient version) as minor pump: use the same settings as above (P 6.1L as major pump), but select Port:Driver 2.
- Using the RID 2.1L you have to configure the flush valve separately (Addr.:1, Pos.: 2, Port: Driver 3, Type: Standard Valve).

In the tab *DESCRIPTION* from the setup (see chapter 4.5 on page 16) you can name these valves and positions in for example solvent selection A and B with the positions A1, A2, B1 and B2 for more clarity.

In *CONTROL INPUTS* you can define event box inputs or game port inputs that stop a run (*STOP ALL*), start a run (*TIME CONTROL START*) or temporarily pause and then resume a run (*TIME CONTROL HOLD/CONTINUE*). Using a trigger cable, you have to choose the Event Box Input 1. Besides if you want to start your pump dependent on the trigger, the PurityChrom.ini-file [Pumps → IOcontrol=1] (see chapter 23 on page 103) has to be modified.

4.2 Presets

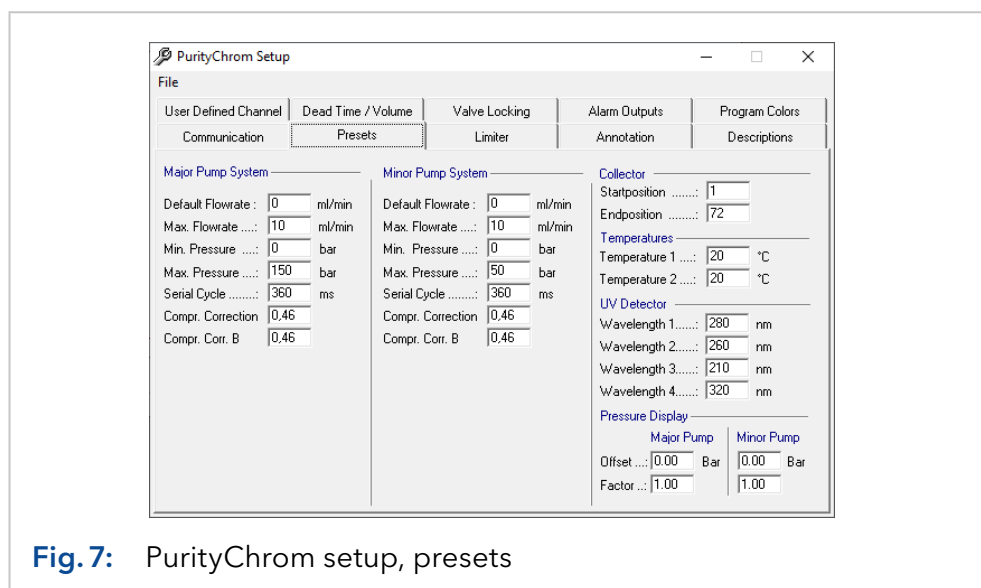

Fig. 7: PurityChrom setup, presets

You can set standard and maximum values for the devices being controlled in the presets setup. You can enter the following values in *MAJOR PUMP SYSTEM* and *MINOR PUMP SYSTEM*:

- **DEFAULT FLOWRATE:** The standard flowrate transmitted to the pumps when the program starts.
- **MAX. FLOWRATE:** The maximum flowrate, which can be chosen by the user.
- **MAX. PRESSURE:** Maximum pressure, the point at which the pumps will stop.
- **MIN. PRESSURE:** Minimum pressure, the point at which the pumps will stop.
- **SERIAL CYCLE:** Time interval at which the status of serial controlled pumps is requested. This setting is given by the driver of KNAUER pumps. For P 2.1L LPG binary: 1000 ms, all other Pumps: 360 ms

- **COMPR. CORRECTION:** Compression factor for used buffers. Use 0,46 for water and 1,10 for ethanol
- **COLLECTOR START POSITION:** It indicates the starting position of the fraction collector when the program starts (for home position 0 has to be chosen).
- **TEMPERATURES:** It indicates two system temperatures that are set when the program starts (e.g. column oven and sample heater).
- **UV DETECTOR WAVELENGTH:** 1 - 4 show the wavelengths of the UV detector when the program starts.

You can use **PRESSURE DISPLAY** to change the program's pressure display to match that of the pumps with the help of an offset and a factor.

If the setup is closed, this presets will be sent to the devices. For example the pumps will start with the set **DEFAULT FLOWRATE**. Therefore we recommend to set the **DEFAULT FLOWRATE** to 0 ml/min.

4.3 Fraction limiter

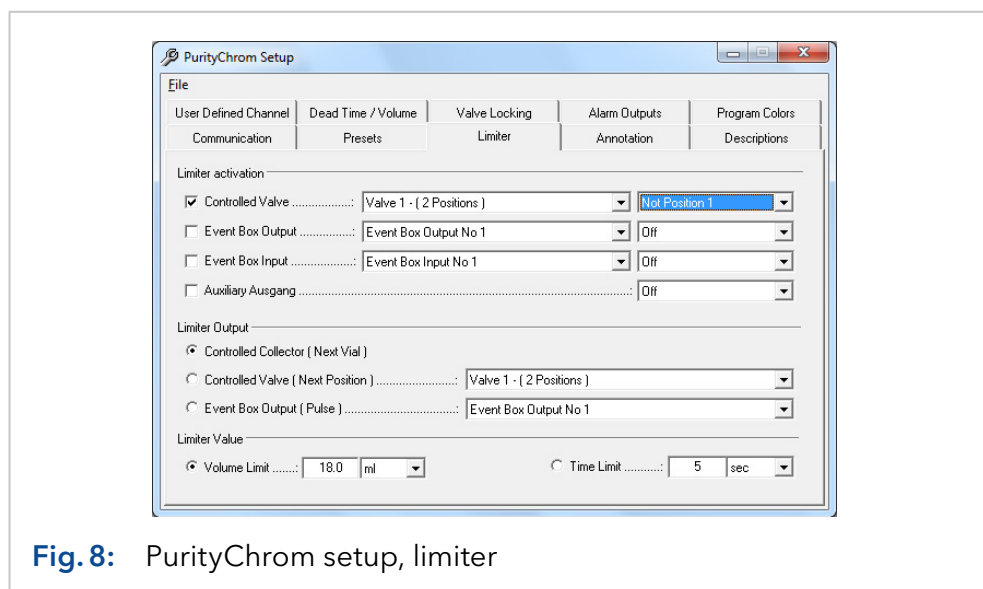

Fig. 8: PurityChrom setup, limiter

The fraction limiter is a feature which calculates the volume of your fraction vial dependent on the flow rate. In the limiter setup the fraction limiter can be configured. In **LIMITER ACTIVATION** you indicate when the fraction limiter should become active. As a rule, this is the point of switching between waste and the fraction. Using a fraction collector you have to choose the valve built in the collector which is responsible for switching between waste and fraction.

- **SERIAL CONTROLLED VALVE** should be activated if you are using a serial or LAN controlled valve for this. Using a multiposition valve for fractionation the first position corresponds to the position **WASTE**. The following position must be the position **FRACTION**.



Note: If no fraction collector or fraction valve is used please deactivate „Controlled Valve“.

- **EVENT BOX OUTPUT** should be activated if you are using an event box output for this. The following output state must be the state **FRACTION**.

- *EVENT BOX INPUT* should be activated if you are recording the fraction position with an event box input. The following input state must be the one for the state *FRACTION*.
- *AUXILIARY OUTPUT* should be activated if you are using the auxiliary output of the pump interface for this. The following output state must be the one for the state *FRACTION*.

Enter in *LIMITER OUTPUT* what the limiter should do when the fraction limit is reached.

The device you are fractionating with should be activated here.

- *SERIAL CONTROLLED COLLECTOR* should be activated if you are using a serial or LAN controlled fraction collector. When the fraction limit is reached, a *STEP* is carried out.
- *SERIAL CONTROLLED VALVE* should be activated if you are using a serial or LAN controlled motor switching valve. When the fraction limit is reached, it switches to the next position.
- *EVENT BOX OUTPUT* should be activated if you are using a fraction collector controlled by the event box. When the fraction limit is reached, there is a pulse at the indicated output.

Enter the volume or time limit for the fractions in *LIMITER VALUE*. After reaching this volume or time the limiter will do what you set in *LIMITER OUTPUT*.

4.4 Annotation

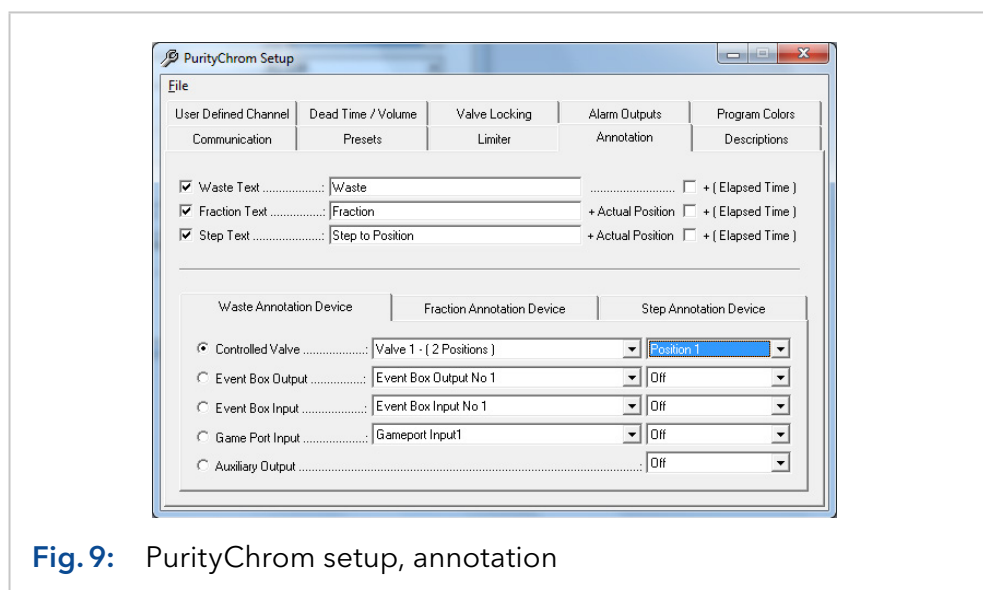

Fig. 9: PurityChrom setup, annotation

The automatic annotations in the chromatograms are configured in the annotation setup.

WASTE TEXT allows you to activate or deactivate an annotation when switching to waste. You are free to choose the text of the waste annotation. The option *+(ELAPSED TIME)* adds the elapsed time to the text.

FRACTION TEXT allows you to activate or deactivate an annotation when switching to the *FRACTION* position. You are also free to choose the text of the fraction annotation.

The fraction number is automatically appended to the text. If you select the *+(ELAPSED TIME)* option, the elapsed time is also added.

STEP TEXT allows you to activate or deactivate an annotation when changing a position. You are also free to choose the text of the step annotation. The fraction number is automatically appended to the text. If you select the *+(ELAPSED TIME)* option, the elapsed time is also added.

In *WASTE ANNOTATION DEVICE* you can enter the device with the position or state that corresponds to the *WASTE* position. (Using a fraction collector you have to enter the valve of the collector with the position that corresponds to the *WASTE* fraction.)

In *FRACTION ANNOTATION DEVICE* you can enter the device with its position or state that corresponds to the *FRACTION* position. (Using a fraction collector you have to enter the valve of the collector with the position that corresponds to the *FRACTION* fraction.)

In *STEP ANNOTATION DEVICE* you can enter the device with which you are fractionating or controlling the fractionating.

4.5 Descriptions

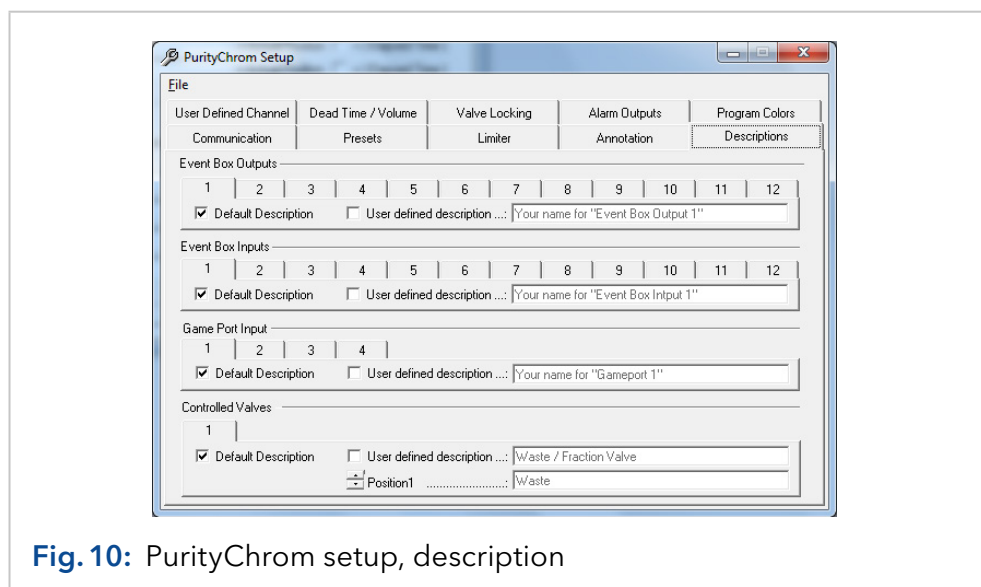

Fig. 10: PurityChrom setup, description

You can give your own names to the event box inputs and outputs, valves and the auxiliary output of the pump interface in the descriptions setup. This makes it easier to program time control files. It also makes the visualisations clearer, since the inputs, outputs and valves can be listed by function.

The *DEFAULT DESCRIPTION* option gives these inputs, outputs and valves their standard description (*EVENT BOX OUTPUT ...*, *EVENT BOX INPUT ...*, *VALVE NO ...* and *AUXILIARY OUTPUT*).

The *USER DEFINED DESCRIPTION* gives you the possibility of entering your own descriptions in the adjacent text boxes.

4.6 User defined channel

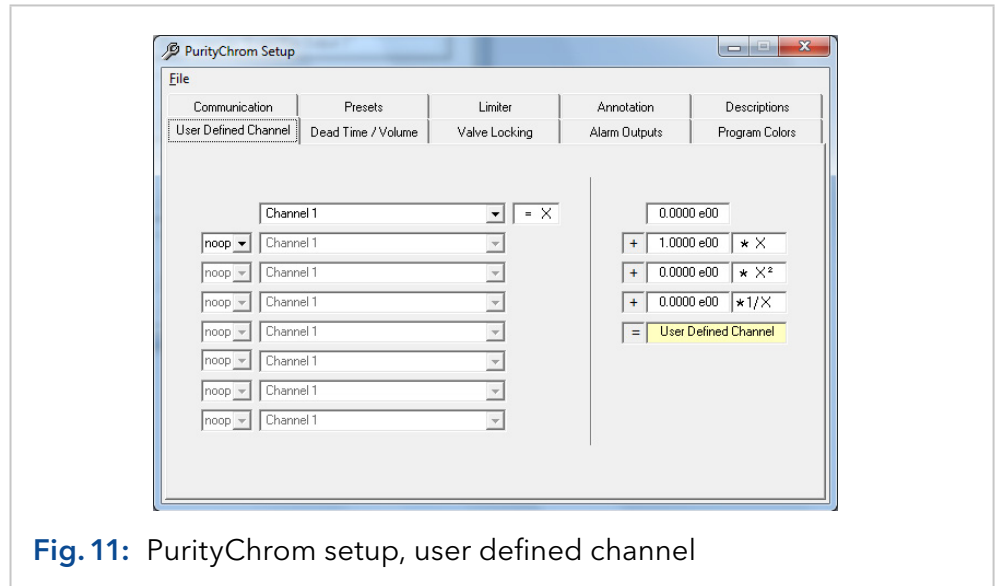

Fig. 11: PurityChrom setup, user defined channel

You can set up a user-defined data channel in the user defined channel setup. This data channel is used in the same way as one of your analogue channels, and carries the description *U*.

On the left hand side, you can activate one or more of your analogue signals as a data source. You have a choice of possible operations between these channels:

Signal	Explanation
<i>NOOP</i>	No operation
+	Addition of the following channel
-	Subtraction of the following channel
*	Multiplication by the following channel
/	Division by the following channel

The result of these operations is on the right side available as value *X* to calculate the *USER DEFINED CHANNEL*. You can enter an offset in the first box. In the second box you can enter a factor to *X*. In the third box you can enter a factor to the square of *X* and in the fourth box, you can enter a factor to the reciprocal of *X*. The addition of the four lines gives the value of your *USER DEFINED CHANNEL*. One Example for the use of this feature is the calculation of the pressure on your column with two pressure monitors before and after your column. The *USER DEFINED CHANNEL* will be the subtraction of the pressure after your column und the pressure in front of the column.

4.7 Dead time / dead volume

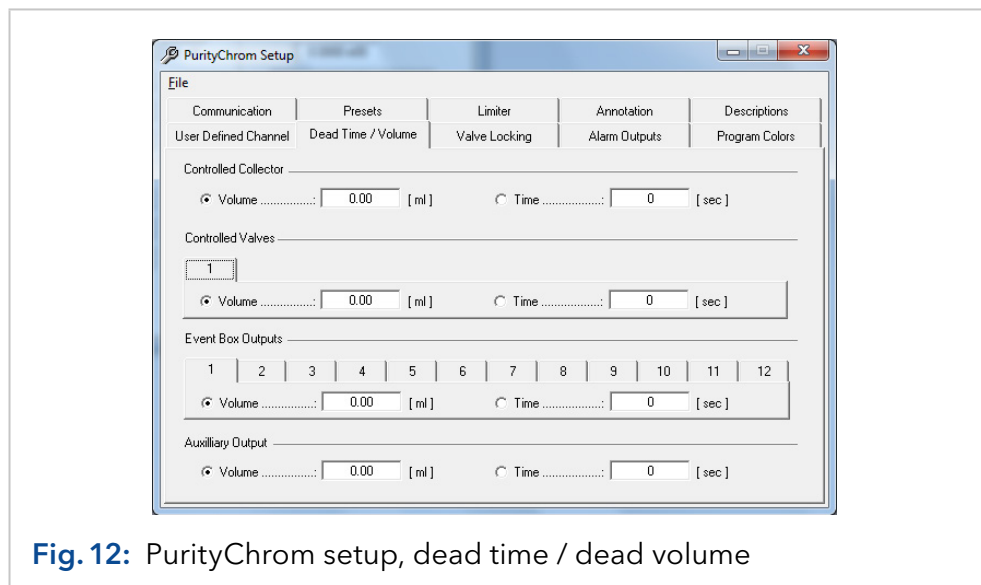

A considerable dead volume can occur in the tubing and valves between the detector cell and the waste/fraction switching valve, which results in a time delay when fractionating, especially at low flow rates. In the Dead Time / Dead Volume setup, you can define the dead volume or dead time of your system. Using a fraction collector, you have to set the dead volume of your system in the section *SERIAL CONTROLLED COLLECTOR* and *SERIAL CONTROLLED VALVES*.

When you enter a dead volume, the program calculates the necessary dead time for each device according to the current flow rate. Functions triggered by threshold values, automatic peak detection as well as fractionation are also carried out with this delay. Therefore keep in mind that the run time have to be long enough to collect all the desired fractions.

When you enter a dead time, this is carried out on a 1:1 basis. Annotations are recorded in the chromatogram without the time delay.

4.8 Valve locking

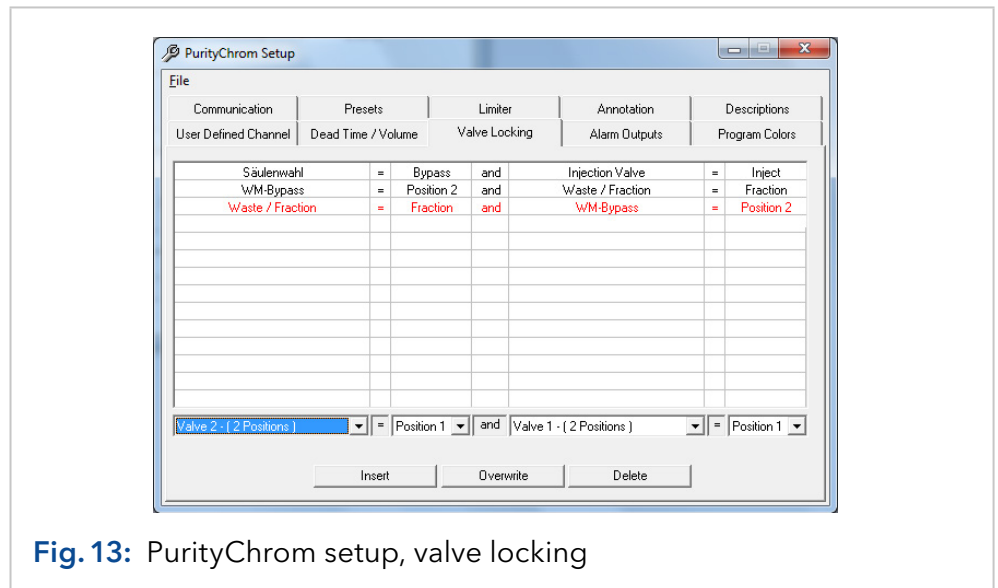

Fig. 13: PurityChrom setup, valve locking

When using several valves, it is possible to switch to non-permitted valve positions or even close off the flow through the system without intending to do so. In order to prevent this, you have the possibility to enter all the non-permitted valve positions in a list in the valve-locking setup. The program will constantly check for these combinations and prevent them from being carried out. If these non-permitted valve positions occur, a message will appear on screen.

To fill in the table, select the non-permitted valve positions in the editing bar underneath the table, and use the *INSERT* button to add it. *OVERWRITE* allows you to write over the row marked in red, or you can delete it with the *DELETE* button. The possible choice of valves in the editing bar only includes the valves configured in *COMMUNICATION*.

4.9 Alarm outputs

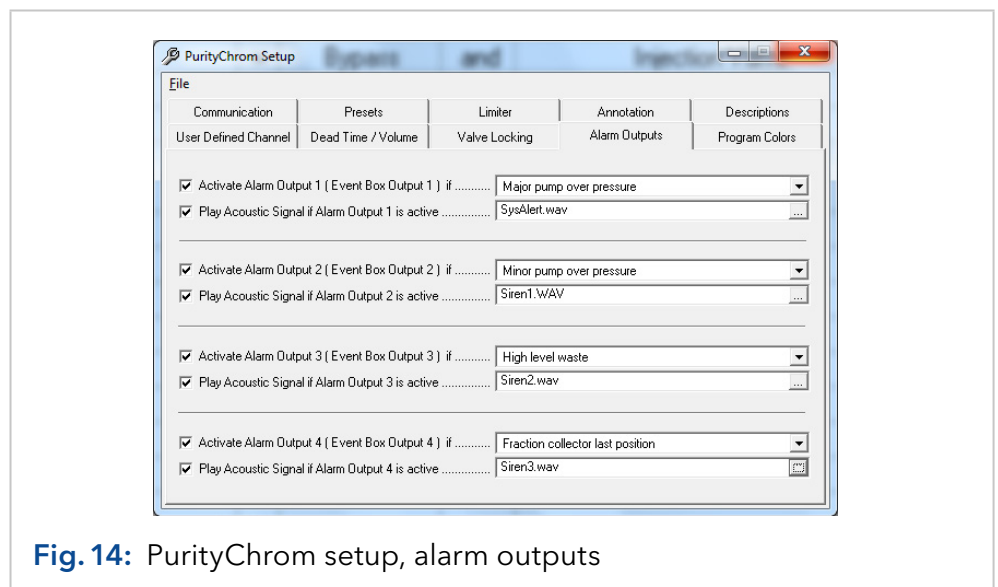

Fig. 14: PurityChrom setup, alarm outputs

Up to 4 alarm outputs can be activated in the alarm outputs setup. The alarm outputs 1 to 4 are set using event box outputs.

Using the corresponding dropdown lists you can configure the respective situations leading to an alarm by choosing from several predefined situations.

The option *PLAY ACOUSTIC SIGNAL IF ALARM OUTPUT IS ACTIVE* activates an acoustic signal, which will be played while the alarm output is active. The signal file can be selected in the adjacent field.

4.10 Program colors

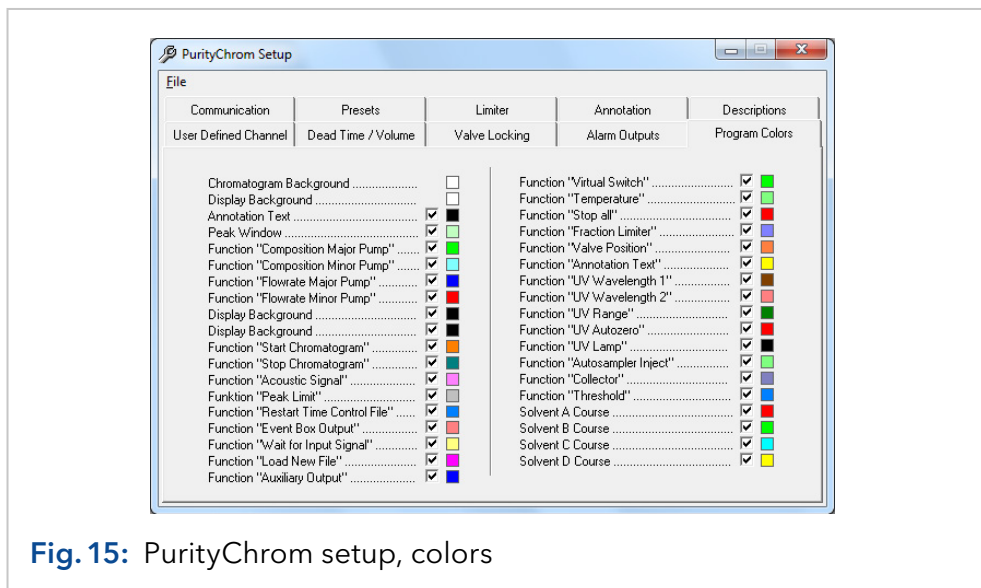



Fig. 15: PurityChrom setup, colors

The Program Colors setup allows the configuration of colors for chromatogram background, annotation texts, peak windows and the graphic time table functions.

For each graphic element or function an adjacent checkbox determines whether the element or function will be displayed. Clicking on the colored boxes opens a color dialog window in which the corresponding display colors can be selected.

5. User administration

5.1 General

The user administration  allows you to set up administrators and users who can be allocated user authorities.

5.2 Working without user administration

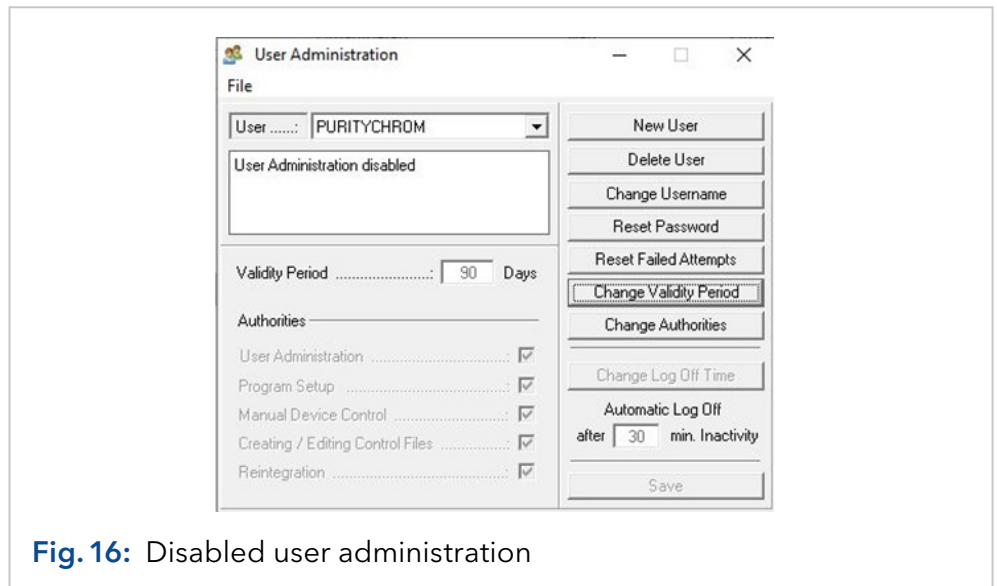

At initial installation the User Administration is deactivated. This setting can be re-established any time. To work without User Administration name the administrator "PURITYCHROM" and allocate the password "KNAUER". This combination of name and password deactivates the User Administration.

5.3 How to activate the user administration

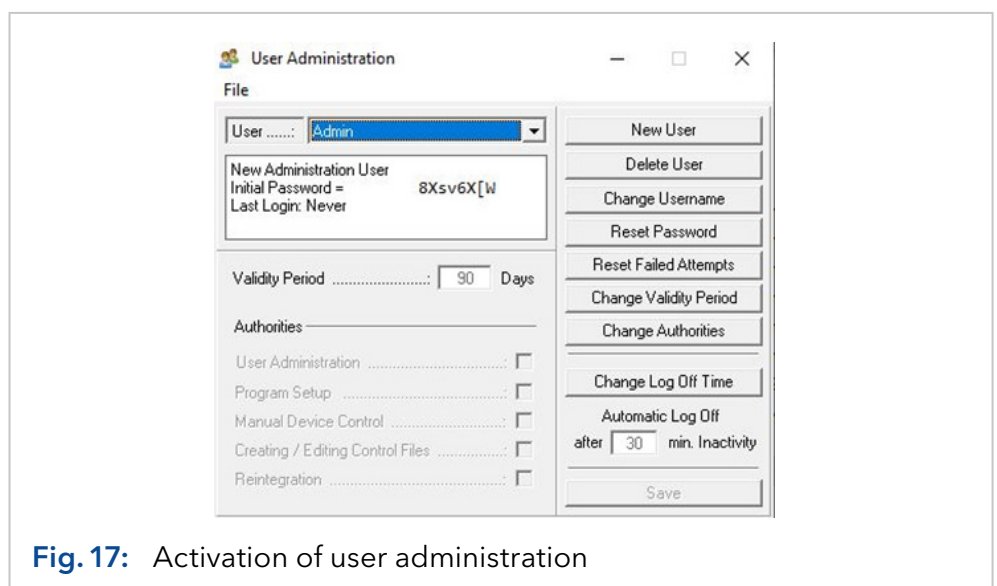

The User Administration will be activated when the password or the user name of the administrator is changed. To change the name of the administrator press the button *CHANGE USERNAME*. When entering a new name you need to respect following restrictions:

- Case sensitivity
- No blanks
- At least 3 characters

To confirm the input of the new user name press the *SAVE* button. In the status window you will get an *INITIAL PASSWORD* which you need to use at your first login.

The first user in the list cannot be deleted and always has administrative rights, which cannot be deactivated.

5.4 Adding a user

To create a new user profile click on the button *NEW USER*. Into the new user interface you can enter the user name, the validity period of the password and assign user authorities.

To confirm the input press the *SAVE* button.

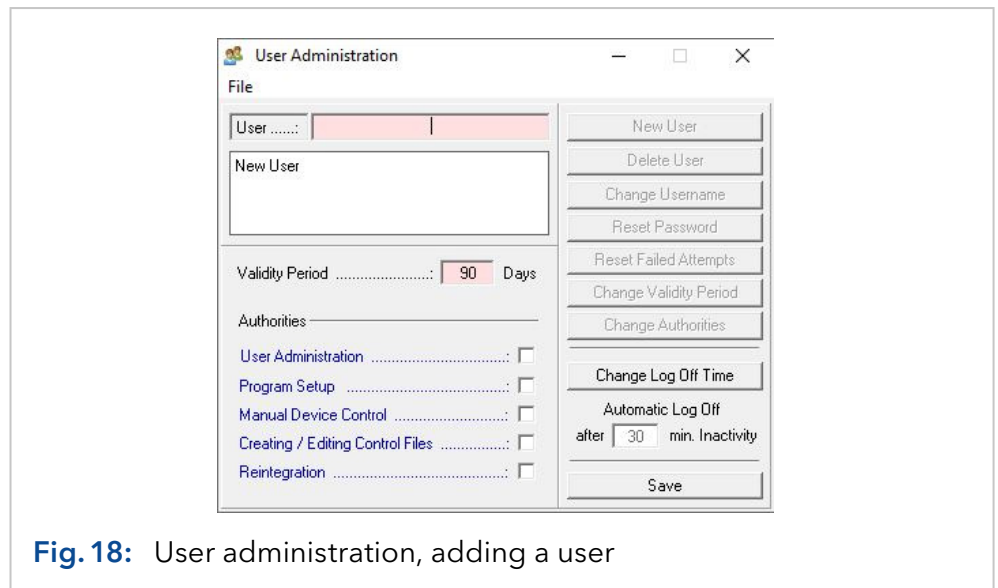

Fig. 18: User administration, adding a user

- *USER NAME* need to have at least 3 characters, no blanks and attend to case sensitivity.
- *VALIDITY PERIOD* defines the duration when the password is valid. After the entered period of time the user need to enter a new password. The validity period can be between 7 and 180 days long.
- *USER ADMINISTRATION* allows access to the User Administration.

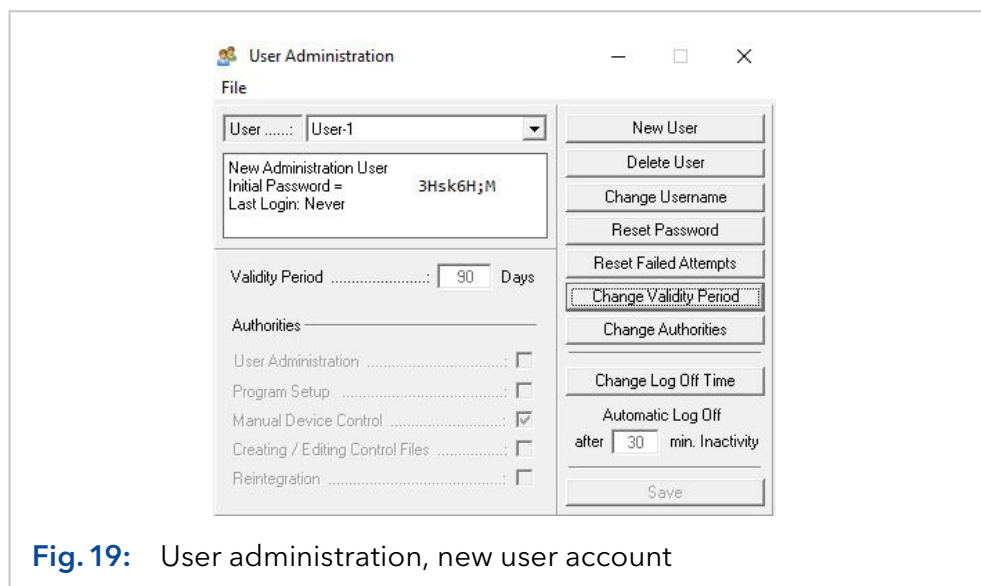

Fig. 19: User administration, new user account

- *PROGRAM SETUP* allows access to the program setup.
- *MANUAL DEVICE CONTROL* allows manual operation of the system using the manual control functions in the main window or the visualisation.
- *CREATING / EDITING CONTROL FILES* allows the creating and editing of time control and autosampler control files.
- *REINTEGRATION* allows the belated integration of the result files.
- *AUTOMATIC LOG OFF* determines the time of inactivity after which the user is logged off. To deactivate Automatic Log Off enter 0 minutes.

By pressing the button of the combination field behind the user name you can switch between the different user interfaces. The initial password for the first login you will find in the status window of the user interface of the new registered operator.

It also shows the administrator some additional information (last login, expiry date of the password).

5.5 Resetting a password

The administrator can reset a forgotten or unsafe password for the affected user. When pressing the "Reset Password" button a new initial password will be generated. The operator needs to use this password for the next login.

5.6 Resetting failed attempts

After three failed attempts to login the account, the operator will be locked. The administrator has the possibility to reset these attempt to give the operator another try to login.

The administrator will get the information, if a user is locked due to failed attempts, in the status window of the user interface.

5.7 User login

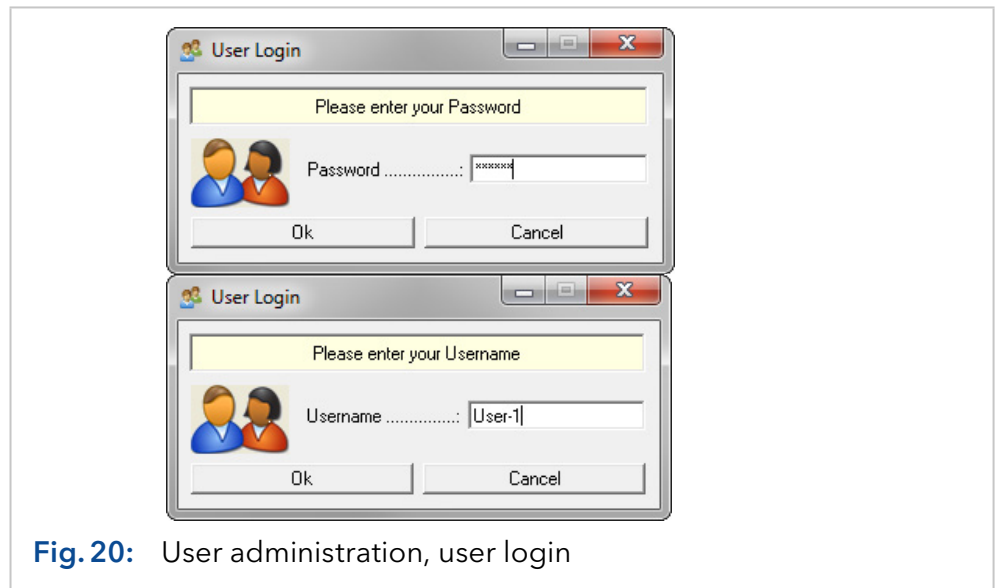

Fig. 20: User administration, user login

When the user administration is activated the operator will get a request window for the login when starting PurityChrom.

The operator needs to identify by entering user name and password.

At the first login after activation or resetting of the password the operator need to use the assigned initial password which was generated when creating the user profile or resetting the password.

The new password needs to be at least 8 characters long and must contain characters from three of the following four categories:

- Lower case letters (a - z)
- Upper case letters (A - Z)
- Base 10 digits (0 - 9)
- Non-alphanumeric special characters: ! , # \$ % & , () * + - . / : ; < = > ?
@ [\] ^ _ { | } ~

After the successful input of the initial password the operator is requested to define and enter a new password.

For safety reasons the operator needs to confirm the password with a second entry.

At the end of the validity period of the password the operator is also asked to enter a new password.

The previously used password will not be accepted.

5.8 Locked account

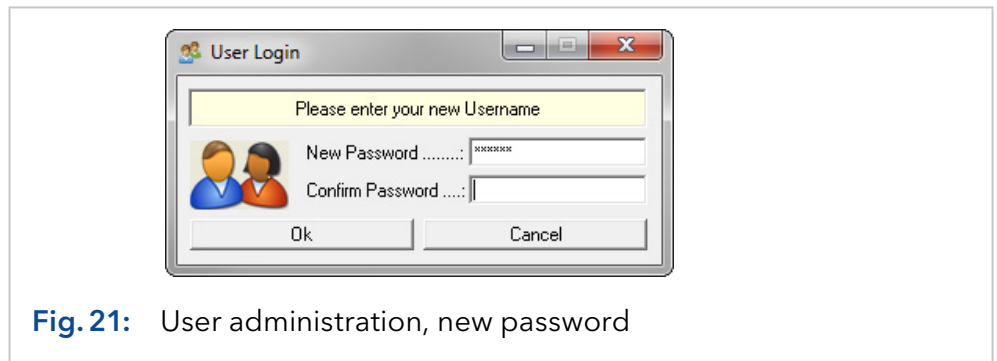

Fig.21: User administration, new password





After three attempts with a wrong password, the account of the user will be locked. The administrator can reset the attempts or reset the password to generate a new initial password.

5.9 Printing the user administration

In order to print a list of all users and their rights select *PRINT USER ADMINISTRATION* in the *FILE* menu. The passwords are not part of the list.

5.10 Function buttons in the audit trail window

The audit trail window can be opened via "File" in the user administration window.

Button	Explanation
	<i>REFRESH DISPLAY</i> refreshes the list according to the selected time period.
	<i>PRINT AUDIT TRAIL</i> opens the printer dialog in order to print the audit trail for the selected time period.
	<i>EXPORT AUDIT TRAIL</i> opens a file selection window in order to export the audit trail to CSV.
	<i>EXIT</i> closes the audit trail window.

6. Creating time control files

6.1 General

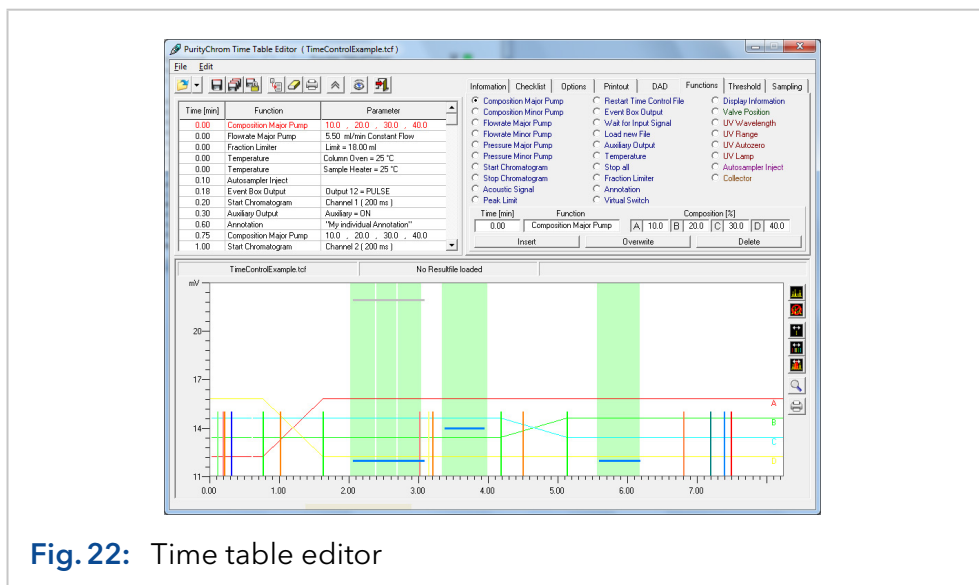



Fig. 22: Time table editor

You can open the time control file editor with the function button  or the menu option *CREATE / EDIT TIME CONTROL FILE* in the main window. The editor shows the time control file in both table and graphic form. The graphic display also allows you to load a chromatogram as a background image, with the help of which the functions of the time control file can be adjusted and checked along the time/volume/column volume and intensity axes. The graphic presentation of the functions, particularly the display of the gradient, ensures increased clarity when programming and thus helps you to avoid making mistakes.

By creating time control files based on time, keep in mind that seconds are indicated as hundredth of minutes.

The functions of the time table need not be programmed in chronological order. They are sorted automatically in the right order on inserting into the time table.

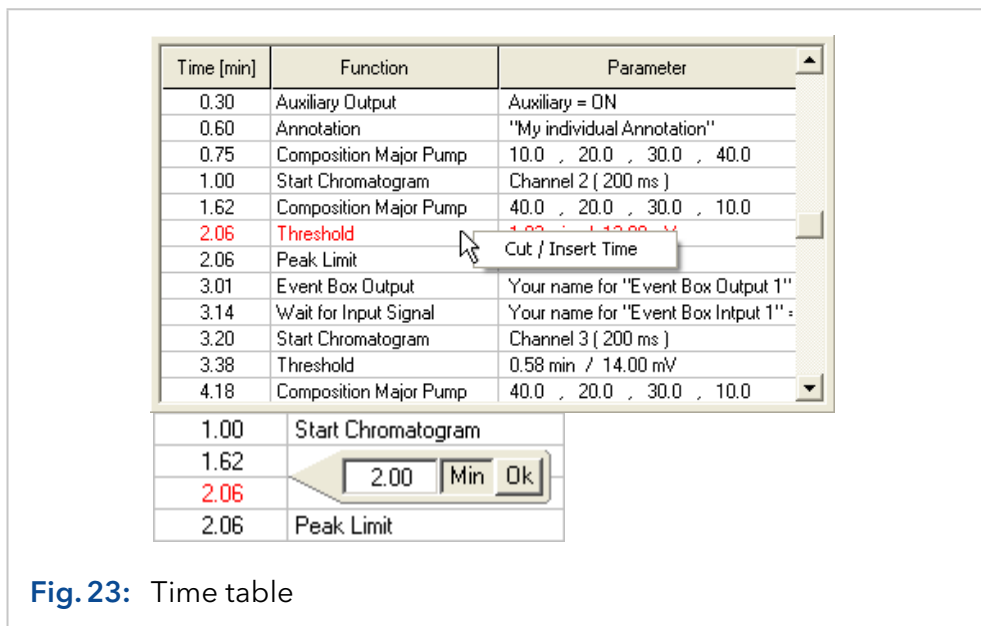

Fig. 23: Time table

If you want to move more than one function of the time table to another time, click with the right mouse button into the first line of the functions to be moved. On clicking into *CUT/INSERT TIME* an entry box appears, where a positive or a negative time can be entered. A positive time moves all following functions to a later time, a negative time moves all functions to an earlier time.

There are certain things you should keep in mind when creating or editing a time control file.

It is a basic principle that every time control file must begin at a time point of 0.00 minutes with an eluent composition and a flow rate, so that the initial conditions of the pumps are set.

All the functions programmed for time point 0.00 minutes are carried out when the time control file is loaded. For this reason, it is sensible use this point in the program to set all the controlled valves to a basic position and to set the event box exits used, so that the system is not left in an undefined state because of previous use or manual operation.

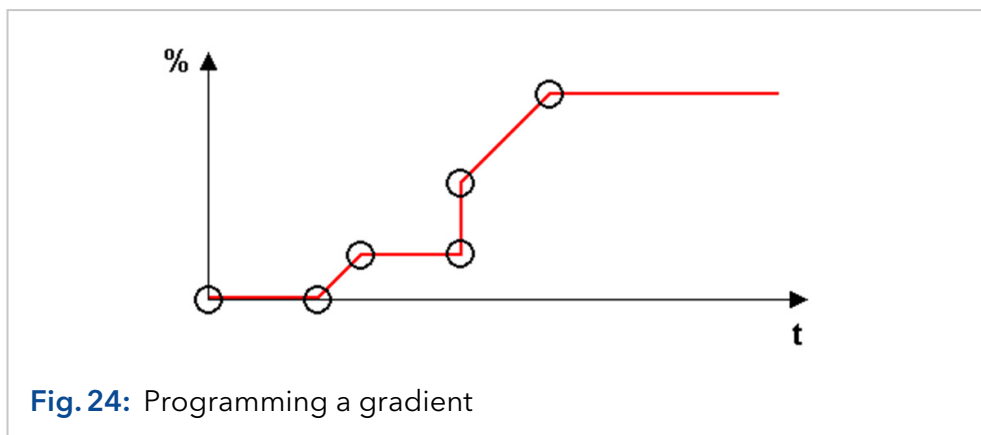











Fig. 24: Programming a gradient

If you want to program a gradient, you should take care that you include all the angles of this gradient as eluent compositions in the time control file. A linear gradient will be calculated between two different eluent compositions at two different times. If you want to program a stepped gradient using our P 2.1L, add start and end points with a time difference of at least 0.06 minutes. The last eluent composition programmed will run isocratically until the time control file is ended by the program or manually.

6.2 Creating a time control file

On the right hand side of the window is the toolbar for the time control file editor. The functions are listed here in the order which corresponds to the display:

Button	Explanation
	<p><i>OPEN TIME CONTROL FILE</i> loads an available time control file into the editor.</p> <p>The types of file you can select to load are: <i>TIME CONTROL FILE (*.tcf)</i>, <i>RESULT FILE (*.rfp)</i> or <i>PURITYCHROM FILE (*.lgr)</i>.</p> <p>The <i>RESULT FILE</i> option allows you to load a time control file from results data. <i>PURITYCHROM FILE</i> allows you to import time control files created with PurityChrom</p>
	<i>SAVE TIME CONTROL FILE</i> saves the time control file under its existing name.
	<i>SAVE TIME CONTROL FILE AS ...</i> saves the time control file under a new name.
	<i>SAVE TIME CONTROL FILE AS VALIDATED</i> saves the time control file as a validated file. This file cannot be modified any more.
	<i>IMPORT TIME CONTROL PART</i> is used to import an element of a time control file. The content of the selected tab can be imported from an existing time control file.
	<i>CLEAR ALL</i> deletes the content of a time control file. In order to prevent the file from being deleted by mistake, this function requires a further confirmation from you before being carried out.
	<i>PRINT TIME CONTROL FILE</i> opens a printer dialogue to print out the time control file.
	<i>HIDE GRAFIC / SHOW GRAFIC</i> hides or shows the graphic time table editor. The window of the time table editor will be reduced or enlarged.

Button	Explanation
	<i>SIMULATION MODE</i> activates a simulation mode for the loaded time table in the time table editor. By clicking a line in the editor the correspondent situation is displayed in the system visualisation.
	<i>EXIT</i> closes the time control file editor.

The selected line is marked in the table with two arrows. With the arrow buttons on the keyboard the next or the previous line can be selected. Using this simulation, basic functions of time tables can be tested. In the system visualisation the appropriate graphic object is marked by a red blinking frame. In addition value labels are showing the parameters of the selected line (solvent compositions, flow rates, UV wavelengths, etc.).

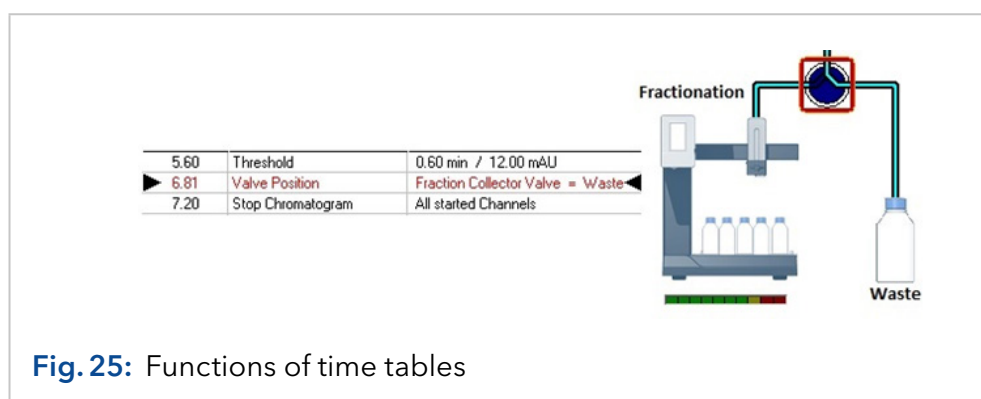
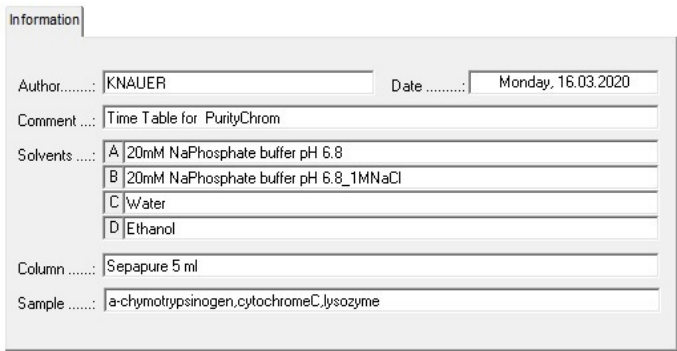

Fig. 25: Functions of time tables

6.2.1 Storing of general information

In the *INFORMATION* tab, you can enter information about the author of the file, the eluents used, the column use, a sample identifier and a general comment. The date is automatically generated when you save the file.



Information

Author.....: KNAUER Date.....: Monday, 16.03.2020

Comment: Time Table for PurityChrom

Solvents: A | 20mM NaPhosphate buffer pH 6.8
 B | 20mM NaPhosphate buffer pH 6.8_1MNaCl
 C | Water
 D | Ethanol

Column: Sepapure 5 ml

Sample: a-chymotrypsinogen,cytochromeC,lysozyme

Fig. 26: General information

The sample identifier is not included when using an autosampler or when the *MANUAL SAMPLE ID* option is activated. The information entered is saved in the results file generated and can be reopened later.

6.2.2 Creation of a checklist

The *CHECKLIST* tab allows you to create an instructionlist or a checklist. The editor bar is at the bottom of the tab, where you can choose between *CHECKBOX* or *USER INPUT*:

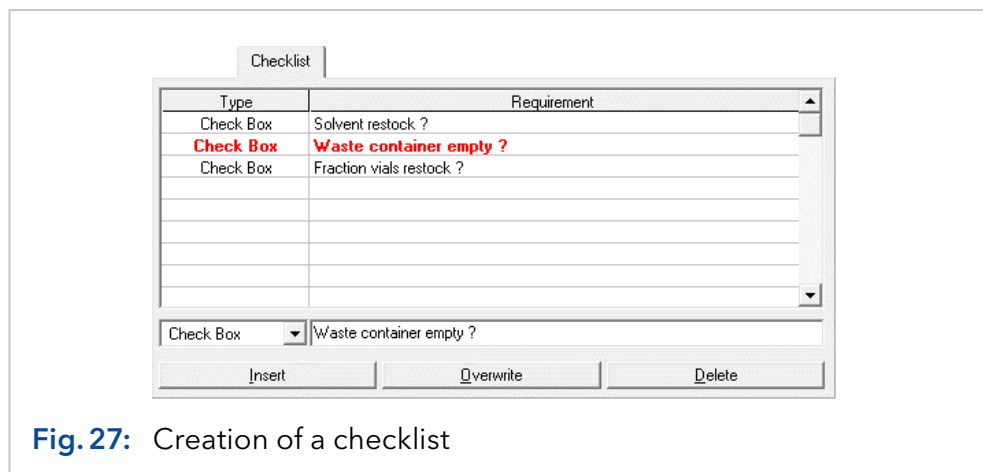

Fig.27: Creation of a checklist

CHECKBOX is an instruction or a control statement. Enter the text of the statement in the input field on the right. This item has to be ticked off by the user before he can start this time control file.

USER INPUT is an input prompt. Enter the text of the prompt in the input field on the right. The user has to enter the demand before he can start this time control file.

The *INSERT* button adds the content of the current editor bar to the checklist. The *OVERWRITE* button overwrites the content of the line you have selected with the contents of the editor bar. The *DELETE* button deletes the line you have selected. To change the order of the lines, left-click on a line and while keeping it pressed move it to the desired place.

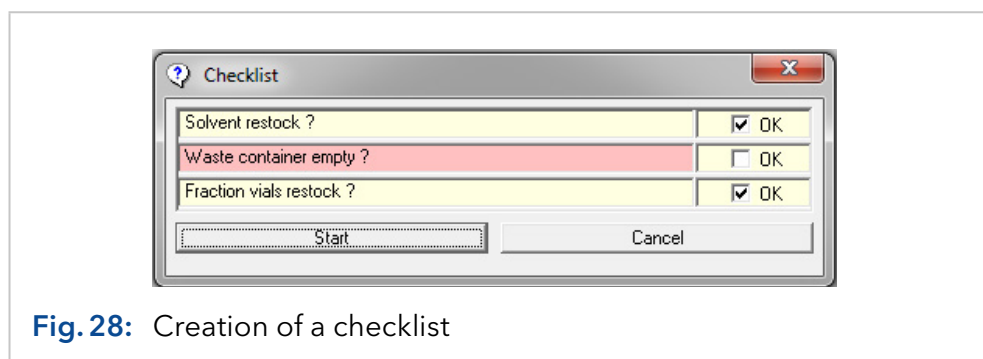

Fig.28: Creation of a checklist

If the checklist of a time control file contains rows, the checklist window will open before starting this file. The user has to tick off all checkboxes and enter all demands before the run begins. A forgotten line will be highlighted in red and prevents the start. The checklist will be logged in the resultfile.

6.2.3 Variables in time tables

The *VARIABLES* tab allows for the definition of variables to be used as parameters for the time table functions. On execution of a time control file the variables values can be set in form of a checklist. Alternatively time control files can be executed within a sequence table. The values of the variables are entered into the sequence table.

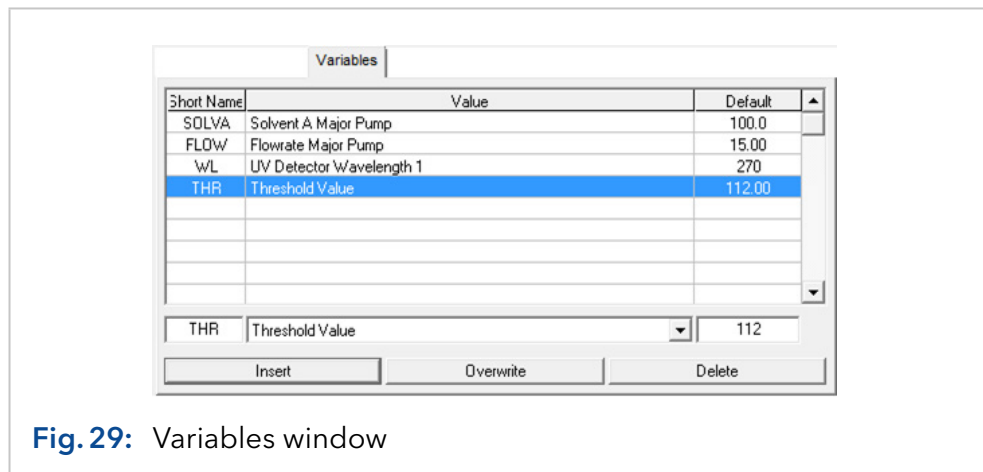

Fig.29: Variables window

The following variables can be defined:

- Composition Major Pump: Solvents A-C
- Flowrate Major Pump
- Composition Minor Pump: Solvents A-C
- Flowrate Minor Pump
- UV Detector Wavelength 1-4
- Wavelength of DAD channels
- Mass of MS channels
- Threshold Value
- Valveposition
- Limiter Value
- Collector Position
- Temperature
- Time of a time table function (including end time of threshold)
- Time shift

In order to insert one of the defined variables while programming a time table press the left mouse button in the parameter text box. A selection menu of all suitable variables appears.

The variable time shift can not be inserted into the timetable. The default value of this variables defines a retention time. All functions following after this retention time will be shifted by a time interval entered in the checklist/sequence table for this variable time shift.

6.2.4 Optional settings

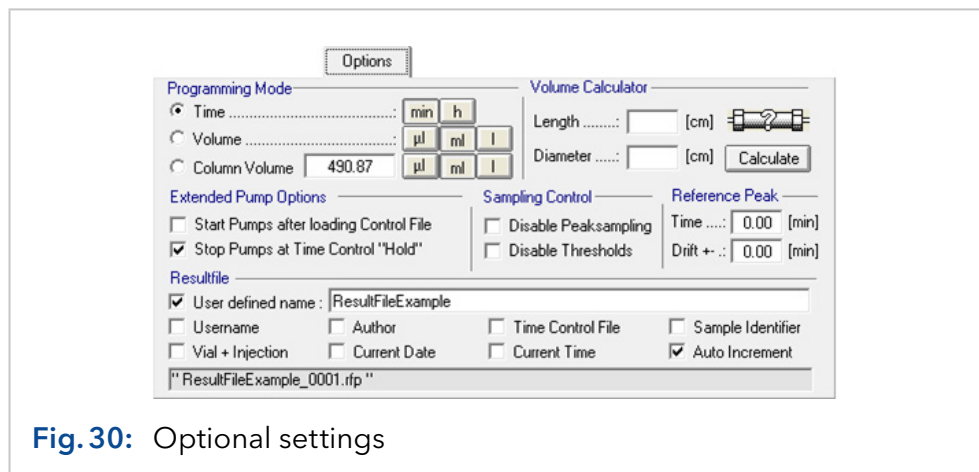

Fig. 30: Optional settings

The *OPTIONS* tab allows you to set the dimensions of the x-axis in *PROGRAMMING MODE*. You have a choice between units of time, volume or column volume. You can also select the size of the units beside each programming mode. To help you determine the column volume when programming in units of column volume, you can use the mini-calculator on the right. To do this, enter the length and internal diameter of the column and click on the *CALCULATE* button. The column volume will then appear in the *COLUMN VOLUME* box.

In *EXTENDED PUMP OPTIONS*, you can use the *START PUMPS AFTER LOADING TIME CONTROL FILE* option to determine whether the pumps should start after loading the time control file, with the parameters programmed for time point 0.00 minutes. The *STOP PUMPS AT TIME CONTROL HOLD* lets you determine whether the pumps should stop when the *HOLD TIME CONTROL FILE* occurs at a flow rate of 0 ml.

SAMPLING CONTROL allows you to deactivate the peak sampling programmed by selecting the *DISABLE PEAK SAMPLING* option. *DISABLE THRESHOLDS* deactivates the thresholds programmed for this time control file. These options allow you to deactivate the collective functions without needing to delete the threshold values or peak samples from a valuable program you may need later.

For the function *REFERENCE PEAK* you will need a reference chromatogram with a reference peak that elutes at a specific time point. This time you can set here. If you program a threshold for this peak you can choose the function reference peak. If the peak elutes in your next run after a different time period all the functions you programmed after the threshold will be postponed due to your set reference time. You can also program a drift. This means all the functions will be postponed due to your reference time plus the drift time. *RESULT FILE* allows you to enter the names of the result files to be generated by this time control file. You can set the file names using the following 9 name segments:

1. *USER-DEFINED NAME* adds a user-defined text to the file name. It should be short enough to fit into the text box.
2. *USERNAME* adds the name of the current user to the file name.
3. *AUTHOR* adds the name of the author of the time control file to the file name.

4. *TIME CONTROL FILE* adds the name of the time control file to the file name.
5. *SAMPLE IDENTIFIER* adds the sample identifier to the file name.
6. *VIAL + INJECTION* adds the number of the current sample vial and the current injection to the file name.
7. *ACTUAL DATE* adds the current date to the file name.
8. *ACTUAL TIME* adds the current time to the file name.
9. *AUTO INCREMENT* adds a four-digit consecutive number to the end of the file name, in order to stop result files with the same name from being overwritten. If you do not want to lose your last file, you should always select this name segment.

6.2.5 Printout options

The *PRINTOUT* tab allows you to setup the content and design of your report file for automatic printing.

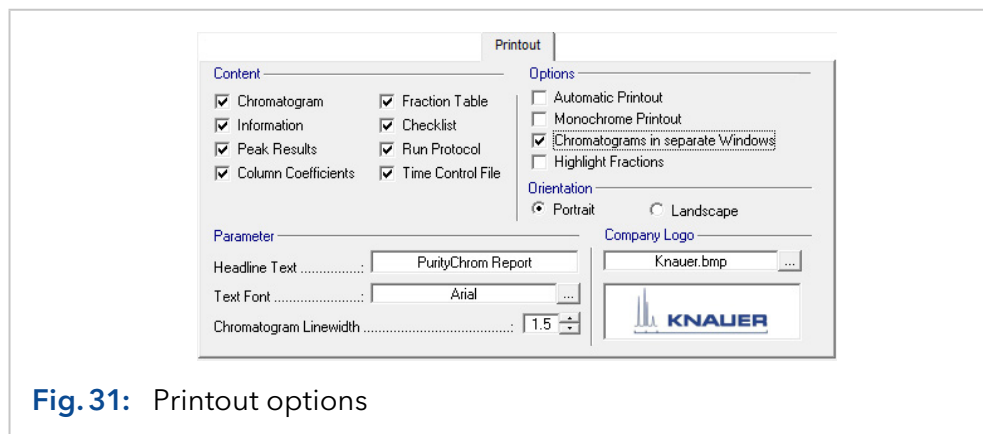

Fig.31: Printout options

In the section *CONTENT* you can define which data you want to include in your printout. Besides the chromatogram you can choose different data, tables and protocols.

In the section *OPTIONS* you can checkmark, if the printout should be executed automatically after each run. It is also possible to choose the option to have each data channel in a separate window and the option for a monochrome printout.

The layout can be varied between portrait and landscape in the section *ORIENTATION*.

In the section *PARAMETER* and *COMPANY LOGO* you can adapt your individual design with an individual headline, text font, line width of data traces and a company logo.

The size of the logo should be 154 to 42 pixels and the type Bitmap.

6.2.6 Settings for diode array detectors

The parameters of the diode array detector are defined in the *DAD* tab. To use a DAD detector you need to scale up the full license with the DAD licence. Select the source of the data channel under *DATA SELECTION*. You can choose either the *A/D* converter board by *A/D CONVERTER* for the conductivity, pH or analog signals or the data of the DAD by *DAD*.

Choose the wavelength range of the DAD channels in the adjacent entry boxes.

For using DAD you cannot choose the wavelength by using the function button "Wavelength" from the main window. Channels are chosen in this window or in the chromatogram view (see Data Channel Setting). The selection of data channels is automatically adopted when loading the time table. Choose the slicewidth (data rate) and bandwidth, otherwise the preset values from PurityChrom.ini file will be taken. A maximum data rate of 10 Hz (100 ms) is supported.

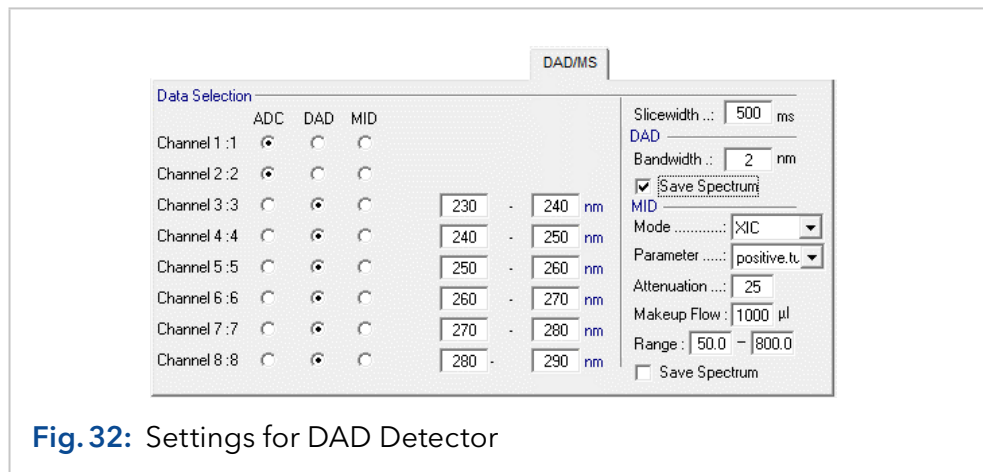

Fig. 32: Settings for DAD Detector

Enter the slice width of the DAD channels in ms in the *SLICEWIDTH* entry box.

The *BANDWIDTH* parameter is used for averaging the measured values in order to reduce signal noise. For a bandwidth of e.g. 5 nm the signal of each wavelength is averaged over a range of + 2 nm. No average value is calculated when a bandwidth of 1 nm is entered.

By choosing the *SAVE SPECTRUM* option the spectra data set of the DAD is saved in the ChromStar DAD data format.

6.2.7 Time control file commands

You will find a list of all the programmable functions of the time control file in the *FUNCTIONS* tab. The editor bar is at the bottom of the tab, where all the functions are to be entered with their time and parameters. The parameter boxes in the editor bar change depending on the function selected. The *INSERT* button adds the content of the current editor bar to the time control file. The order in which you make your entries is irrelevant, since all the lines of program are ordered chronologically. The *OVERWRITE* button overwrites the content of the line you have selected with the contents of the editor bar. The *DELETE* button deletes the line you have selected.

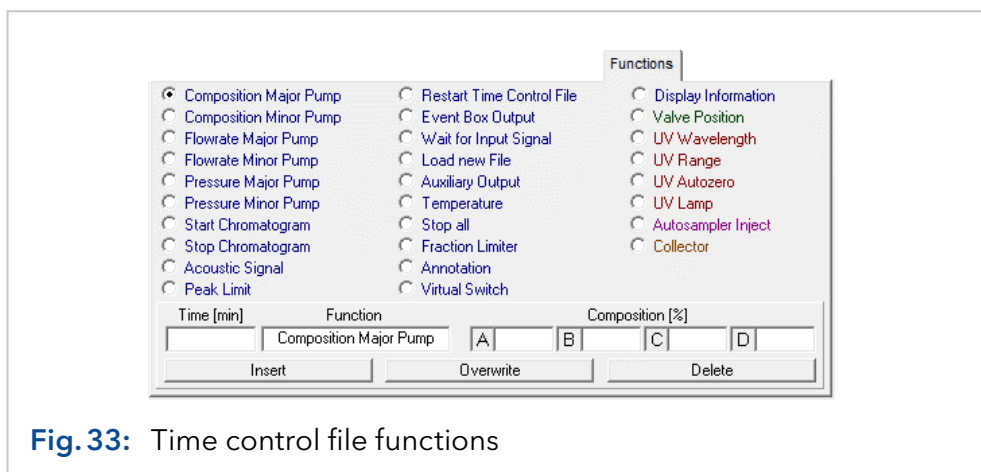

Fig. 33: Time control file functions

COMPOSITION MAJOR PUMP determines the eluent composition for the primary pumps in the system. Entries are made in percent, and while you are making the entries, the entry in the following box always makes up the difference to 100%.

COMPOSITION MINOR PUMP determines the eluent composition for the secondary pumps in the system (e.g. column conditioning, sample application etc.). Entries are also made in percent.

FLOW RATE MAJOR PUMP determines the flow rate of the primary pumps in the system. Changes are made in steps, i.e. a flow rate gradient cannot be generated. Entries are made in ml/min. It is also possible to set a constant pressure for the major pump. In this case the pump will adapt the flow rate according to the set pressure (not supported by KNAUER pumps).

FLOW RATE MINOR PUMP determines the flow rate for the secondary pumps in the system. Entries are also made in ml/min. It is also possible to set a constant pressure for the major pump. In this case the pump will adapt the flow rate according to the set pressure (not supported by KNAUER pumps).

PRESSURE MAJOR PUMP determines the behaviour of the pump at the inscribed values. The set value will be sent to the pump and will be remembered. By opening and saving the setup or restarting the software the set maximum and minimum pressure in the tab *PRESETS* from the setup will be sent to the pump.

- Minimum Pressure: Pausing of the method and stopping of the pump when the pressure was constantly below the appointed value for 20 seconds.
- Maximum Pressure: Pausing of the method and stopping of the pump when the pressure when the appointed value is exceeded.
- Pressure Limit (not supported by KNAUER pumps): Automatic flow rate control starts working when the appointed value is achieved.

PRESSURE MINOR PUMP determines the behaviour of the pump at the inscribed values. By opening and saving the setup or restarting the software the set maximum and minimum pressure in the tab *PRESETS* from the setup will be sent to the pump.

- Minimum Pressure: Pausing of the method and stopping of the pump when the pressure was constantly below the appointed value for 20 seconds.

- Maximum Pressure: Pausing of the method and stopping of the pump when the pressure when the appointed value is exceeded.
- Pressure Limit (not supported by KNAUER pumps): Automatic flow rate control starts working when the appointed value is achieved.

START CHROMATOGRAM starts plotting the chromatogram for the channels selected, with the data point density entered under *SLICE WIDTH* (max. 60 ms). UV channels will occupy the first channels and the conductivity signal, the pH signal and the temperature or the RID channel will follow in this order. The last channels are occupied by FLD or interface box channels. The basic license includes three data channels plus flow rate and pressure recording. The full license supports eight data channels plus flow rate and pressure recording.

STOP CHROMATOGRAM stops plotting the chromatogram for the analogue channels selected or, if *ALL ACTIVE* is selected, stops plotting the chromatogram for all the analogue channels started.

ACOUSTIC SIGNAL initiates a sound reproduction of the wave file selected with an interval of 4 seconds. The test button  allows you to hear the file. The sound will end when the time control file is stopped.

PEAK LIMIT is used to monitor peak heights and peak times. It works in conjunction with the *RESTART* command and takes effect when the time control file is restarted during cyclic effluents. The end time in minutes (*END*) and the limit value in mV (*VALUE*) must be entered as parameters. A peak limit only allows the time control file to restart when one or more peaks exceeds the limit value and then falls back below this value during the time duration of the time control file. If one or more peak limits fail, the *RESTART* command will be ignored and you will receive an error message on screen.

RESTART TIME CONTROL FILE is used to restart the time control file. You can select the parameter Loop for an endless loop, or Repeats in order to enter a certain number of repeats. Once all the repeats have been carried out, this command will be ignored. Therefore you have to program this function at the end of you time table and before the function *STOP ALL*. Before you restart your time control file use the function *STOP CHROMATOGRAM* to restart your data recording.

EVENT BOX OUTPUT is used to switch one of the 12 event box outputs. The required event box output and the state to be switched to (Off, On, Pulse) must be selected as parameters. *PULSE* means that the event has to be switched on and off again.

WAIT FOR INPUT interrupts the continuation of the time control file through time (*HOLD FUNCTION*) until the selected event box input or the game port has the state programmed *OFF, ON* or *PULSE*.

- Off: The time table will continue if the trigger stays off.
- On: The time table will continue if the trigger switches to the state on and produces a short-circuit.
- Pulse: The time table will continue if the trigger switches to the state on and off again. This function can be used when injecting by means of a manual injection valve, for example. You cannot use this function at the time/volume/column volume 0.00. If you want to use the trigger to start a time table you have to enable the respective event box input or game port input in the input field *TIME CONTROL START* (see chapter 4.1 on page 12).

If you use a trigger cable, you have to choose the Event Box Input 1. Besides, if you want to start your pump dependent on the trigger, the PurityChrom.ini-file [Pumps → IOcontrol=1] (see chapter 23 on page 103) has to be modified.

LOAD NEW FILE is used to load and start the time control file selected. This allows you to link several time control files together.

AUXILIARY OUTPUT is used to switch the pump interface's auxiliary output. This function allows you to control a relay contact. You can select *ON* or *OFF* as parameters.

TEMPERATURE is used to program up to two system temperatures. The parameters are the temperatures in °C.

STOP ALL is used to end a run and stop the pumps.

FRACTION LIMITER is used to program fraction limits. You can enter a maximum volume in ml or a maximum time in seconds. The value programmed will not change the limiter setup, but will be adopted as a current value.

ANNOTATION is used to add manual text annotations to the chromatograms.

VIRTUAL SWITCH is used to program up to 10 virtual switches. This virtual switch is only a variable that can be set to 0 or 1. Example: You can link this switch with a button in your visualisation. In your time control file you can program to wait for the virtual switch set to 1 using the function *WAIT FOR INPUT*. Then your time control file will be hold until you switch the virtual switch to 1 by pressing the button in your visualisation. These virtual switches can have the state *ON* or *OFF*.

DISPLAY INFORMATION is used to display user defined information which are shown in the Information label of the system visualisation.

VALVE POSITION is used to switch valves. Select the desired valve and position as parameters.

UV WAVELENGTH is used to program up to 4 wavelengths of a UV detector, depending on the detector.

UV RANGE is used to program the range value of a UV detector.

UV AUTOZERO makes the UV detector automatically return to zero.

UV LAMP is used to switch on or off the lamp from the UV detector (only when supported).

AUTOSAMPLER INJECT is used to carry out an injection from an autosampler. You need the full license to use an autosampler. This function can only be used in conjunction with an autosampler control file or in a sequence table. The course of the time control file is paused during the injection phase and the *ELAPSED TIME* display in the main window shows the time passed and Injection alternately.

COLLECTOR is used to program a fraction collector position. The parameters can be a return to the home position (*HOME*), a move to a further position (*STEP*) or a position number (*POSITION*).

6.3 Using the AZURA® pump P 6.1L (high pressure gradient version)

Using the P 6.1L (high pressure gradient version) you have to configure the solvent selection valve separately by choosing two standard valves (see chapter 4.2 on page 13). The first valve can switch between A1 (position 1) and A2 (position 2) and the second between B1 (position 1) and B2 (position 2). Use the starting point of your time table control file to set these valves to the position that corresponds to your wanted solvent.



Note: During a run it is not recommended to switch these valves.

6.4 Fractionating with a fraction collector

First you have to configure the valve of your fraction collector in the PurityChrom setup (see chapter 4.3 on page 14), the annotations (see chapter 4.4 on page 15), the dead volume or time (see chapter 4.7 on page 18) and your rack that you want to use (see chapter 17.4 on page 88). At the respective time point at which you want to start fractionating you have to choose the function collector and tell the collector arm the position at which it should start fractionating. If you choose *STEP*, it will switch to the next position in the rack.

The actual position of the fraction collector arm will be remembered until the program is switched off and on again. By programming the function *COLLECTOR STEP* at the start of the time table control file, the arm will step to the next position when the time control file is loaded and again when it is started. To avoid that you can program that function at for example 0.01. Next you have to switch the valve of the fraction collector from waste to fraction and set a volume or time limit, but only if it is different from the set limit in the setup (see chapter 4.3 on page 14).

6.5 Fractionating with a multiposition valve

First you have to configure the valve in the PurityChrom setup (see chapter 4.3 on page 14), the annotations (see chapter 4.4 on page 15), the dead volume or time (see chapter 4.7 on page 18). At the respective time point at which you want to start fractionating you have to switch multiposition valve from waste to fraction and set a volume or time limit, but only if it is different from the set limit in the setup (see chapter 4.3 on page 14). You can choose distinct position or you choose the command *NEXT STEP* to go automatically to the next position. The positions of your collected fractions will not be remembered by the software after changing to waste position.

If you need the valve to remember its position after switching to waste and you are working with a KNAUER multiposition valve, it is possible to combine a virtual valve with the physical valve to achieve this. For this you need to configure two valves in the PurityChrom Setup. The virtual valve will switch between waste and fraction and the multiposition valve will work as usual.

In the setup the virtual valve has to be configured with the same address and winsock port as the multiposition valve, but with two positions. The multiposition valve will be configured as usual.

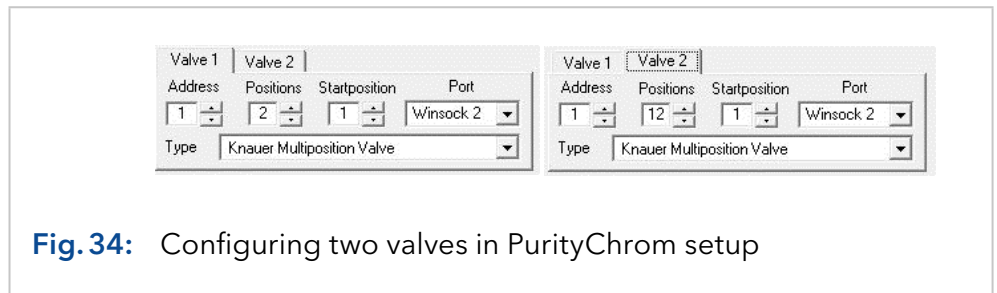

Fig. 34: Configuring two valves in PurityChrom setup

To set the Limiter, use the virtual valve for *LIMITERACTIVATION* when it is not in waste position and the multiposition valve as limiter output valve.

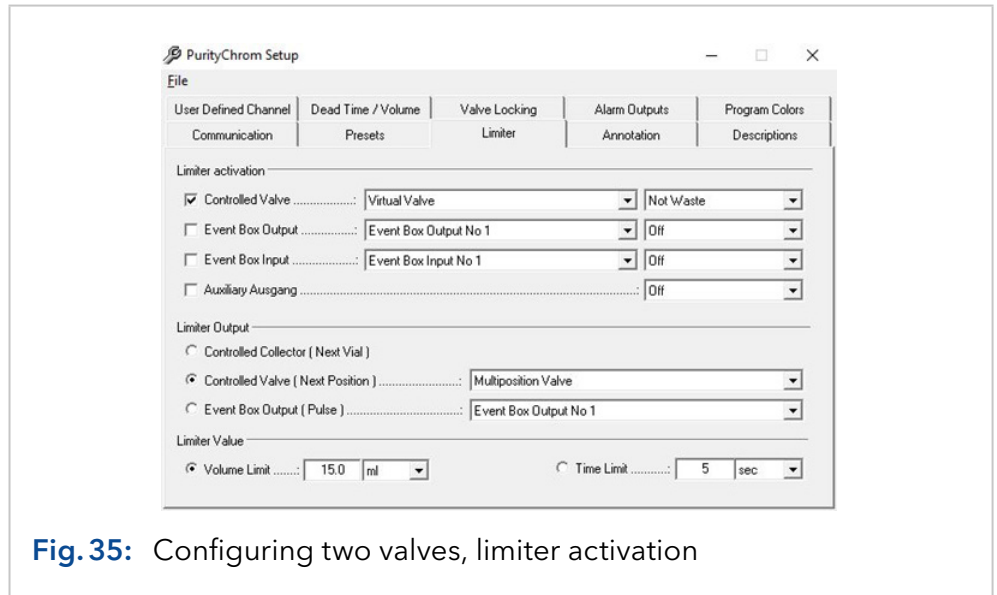

Fig. 35: Configuring two valves, limiter activation

In the annotation tab, set the annotations as follows:

- Waste Annotation Device: Controlled Valve: Virtual Valve in Waste

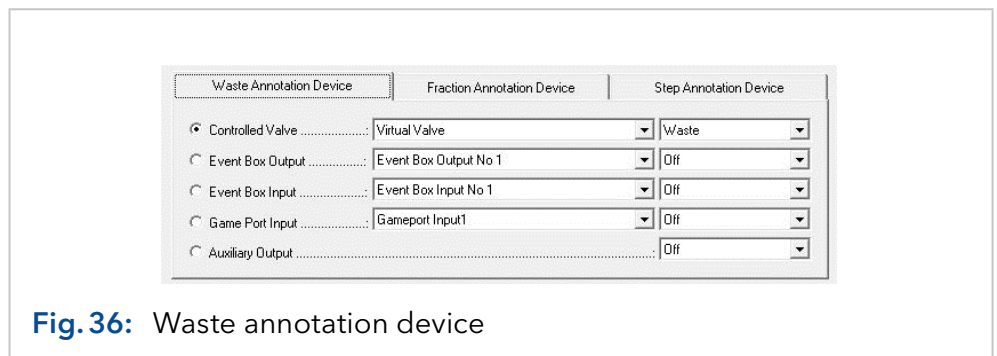

Fig. 36: Waste annotation device

- Fraction Annotation Device: Controlled Valve: Virtual valve in Fraction

Fig. 37: Fraction annotation device

- Step Annotation Device: Controlled Valve Position Change: Multiposition valve

Fig. 38: Step annotation device

When writing a method now use the threshold for fractionation and set in the threshold over event the virtual valve into fractionation position and the multiposition valve to next position.



Note: Make sure not to change the order of those two functions!

In the threshold under event set the virtual valve into the waste position.

If you want to control the fractionation also via the visualization, you have to set both valves in the visualization. The virtual valve turns off the limiter and the multiposition valve defines the fraction position.

TIPP: Use the On/Off button as visualization element for the virtual valve.

6.6 Programming thresholds

THRESHOLD: The *THRESHOLD* tab allows you to program thresholds, meaning that a series of device control functions can be executed if a value exceeds or drops below the threshold. The threshold values allow individual fractionating or system monitoring possibilities, thanks to their selectable data source, programmable time frames for activities and programmable threshold levels. Up to 50 threshold values can be active at any one time.

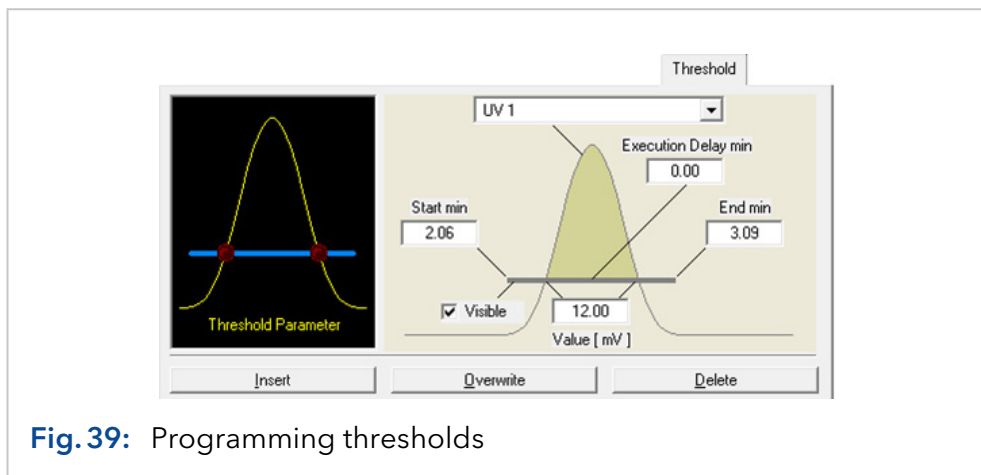

Fig.39: Programming thresholds

The graph on the left of the tab is used to select the threshold parameters. Click on the graph next to the LEDs and the boxes for the general threshold parameters will appear. You can select the data source of a threshold value in the upper box. You can choose between all the analogue channels, the system pressure, the event box inputs and the game port inputs.

START TIME and **END TIME**: The boxes **START TIME** and **END TIME** set the time frame for the activity of the threshold.

VALUE: The **VALUE** box is for the threshold value. When using event box or game port inputs, this parameter is not available, since the data source only has two possible states (Low = Threshold Under Event, High = Threshold Over Event).

EXECUTION DELAY: The **EXECUTION DELAY** parameter delays the execution of the programmed functions of the **OVER EVENT FUNCTIONS** in this threshold.

VISIBLE: By choosing the **VISIBLE** option the graphic line of this threshold will be displayed in the analysis windows. Otherwise it will be invisible.

Click on the left-hand LED in the graph and the function table of the **OVER EVENT FUNCTIONS** will appear, in other words the functions that are carried out if the threshold value is exceeded.

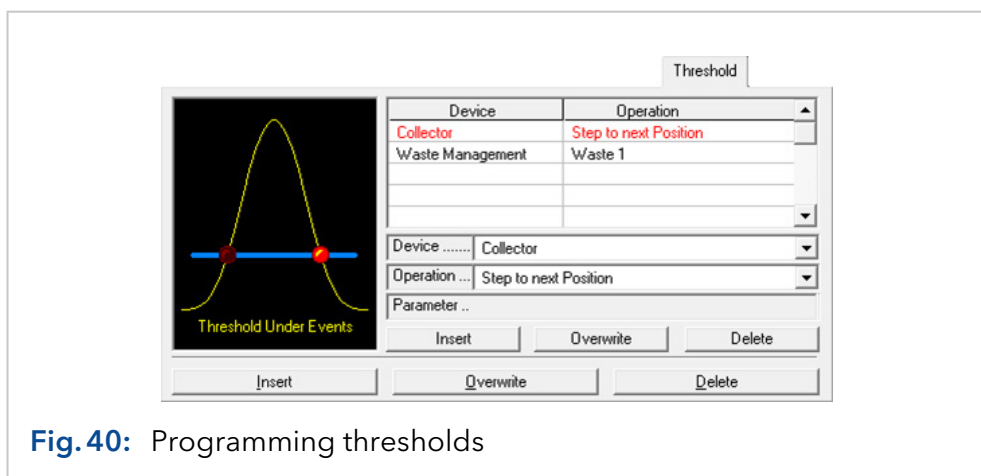

Fig.40: Programming thresholds

The selection boxes **DEVICE** and **OPERATION** allow you to set the desired function, and the **INSERT** button adds these functions to the time control file.

You can use the *OVERWRITE* button to overwrite a selected line, and *DELETE* to delete it. If you click on the right-hand LED, the function table of the *UNDER EVENT FUNCTIONS* appears, i.e. the functions that are carried out when the value is less than the threshold. Functions can be set in exactly the same way here as for *OVER EVENTS*.

6.7 Programming threshold with logic gates

As Over and Under Events functions the inputs of logic gates can be set. Logic gates can be used to monitor several channels simultaneously and to use the combination of these channels as input for the fractionation. PurityChrom handles 10 individual logical gates. For each gate several inputs of four internal gates can be set to 0 or 1. The four internal gates are or-gates (OR), and-gates (AND), not-and-gates (NAND) and exclusive-or-gates (XOR). These internal gates are evaluated in the order: OR-AND-NAND-XOR. If an internal gate gives a result of 0 the evaluation is stopped, and the logic gate is set to 0 in total. E.g. if inputs of the OR-gate are evaluated and the result is 0 the other logical gates are not processed.

The several inputs and one output of a logic gate can have the binary values 0 or 1.

A	B	Y	A	B	Y	A	B	Y	A	B	Y
0	0	0	0	0	0	0	0	1	0	0	0
0	1	1	0	1	0	0	1	1	0	1	1
1	0	1	1	0	0	1	0	1	1	0	1
1	1	1	1	1	1	1	1	0	1	1	0
OR-Gate			AND-Gate			NAND-Gate			XOR-Gate		

Fig.41: Truth table of logic gates

The output of the OR-gate has the value 1 if at least 1 input value is 1. The output of the AND-gate is 1 if all inputs are 1. The output of the NAND-gate is 1 if at least one input is 1 and the output of the XOR-gate is 1 if exactly 1 input is 1. The logical operations leading to the outputs are illustrated in the truth tables for the four logic gates used.

Example: Logic gates can be used to collect fractions in case a defined UV-channel (channel 1) and a defined MS-channel (channel 2) are above threshold while another MS-channel (channel 3) is not above threshold.

Threshold 1 is programmed for channel 1: if the threshold is exceeded an AND-input of logic gate 1 is set to 1, if the channel value falls below the threshold the input is set back to 0. This is done by setting an AND-input of logic gate 1 to 1 and 0 in case of an „Over Event“ or „Under Event“.

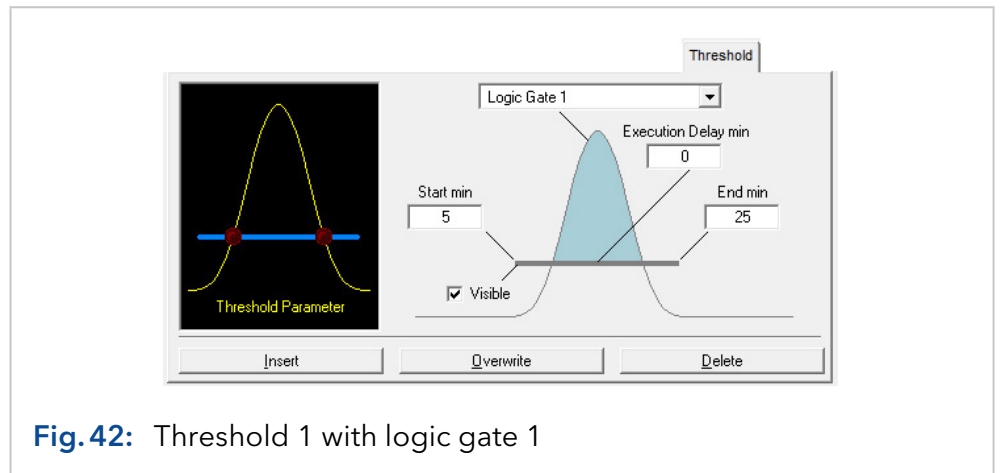

Fig.42: Threshold 1 with logic gate 1

In the same way another threshold monitoring channel 2 is programmed, setting another AND-input of logic gate 1 to 1 and to 0, respectively. A third threshold monitors channel 3 and sets the NAND-input of logic gate 1 to 1 and 0 in case of an „Over Event“ or „Under Event“.

The output of logic gate 1 now is 1 in case both signals of channel 1 and 2 are above threshold while channel 3 is below threshold. This behaviour can also be demonstrated by the corresponding truth table combining the AND-inputs A and B with the NAND-input C to output Y of the logical gate. If the AND of channels 1 and 2 is 0 the NAND is not evaluated (hashed fields in the truth table).

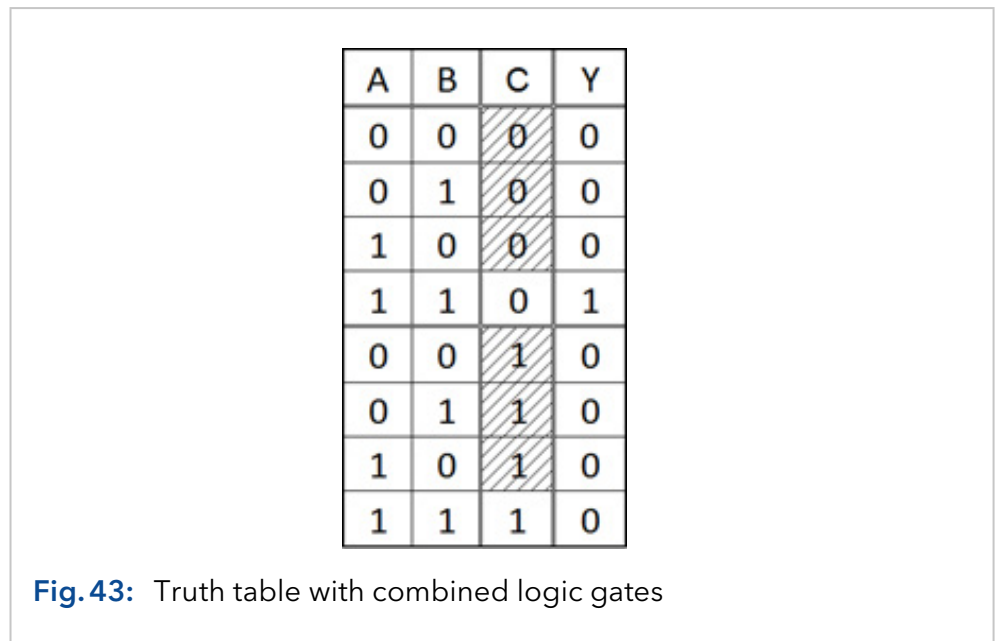

Fig.43: Truth table with combined logic gates

Another threshold using logic gate 1 as input can be used for the fractionation.

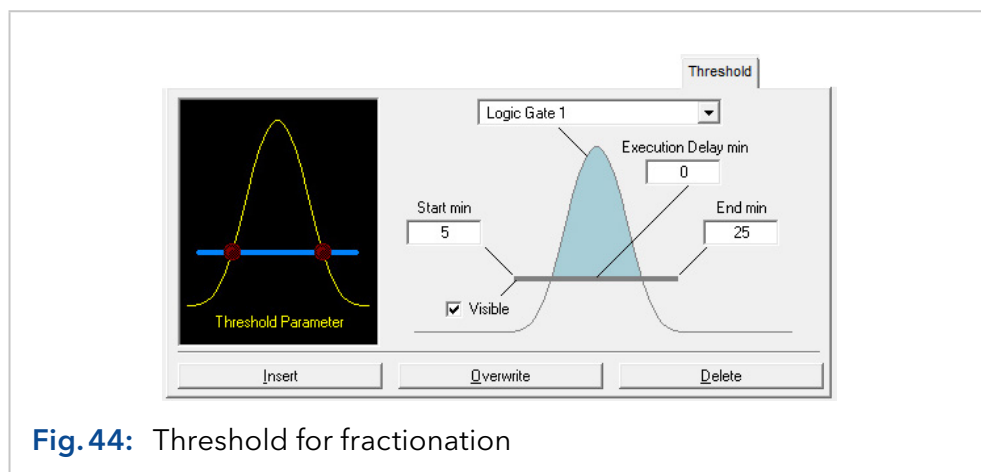

Fig.44: Threshold for fractionation

6.8 Programming peak sampling

The *SAMPLING* tab allows you to program peak sampling. Peak sampling is a way of carrying out a series of device control functions on the basis of automatically recognised peak situations. Peak sampling takes place in peak windows, the start and end times of which can be set by the user. You can select the data source, sensitivity of peak recognition and the functions to be carried out separately for each peak window. This allows you to react to single peaks on an individual basis.

When fractionating in combination with threshold values, the thresholds and peak sampling always combine to form one fractionation event. This means that as long as the threshold is still exceeded or the peak sampling has not yet recognised the end of a peak, fractionating continues.

The graph of peak situations is used to select the peak sampling parameters and peak situations. Click on the graph next to the LEDs and the boxes where you can enter the peak sampling parameters will appear. You can choose the peak window you require from the graph.

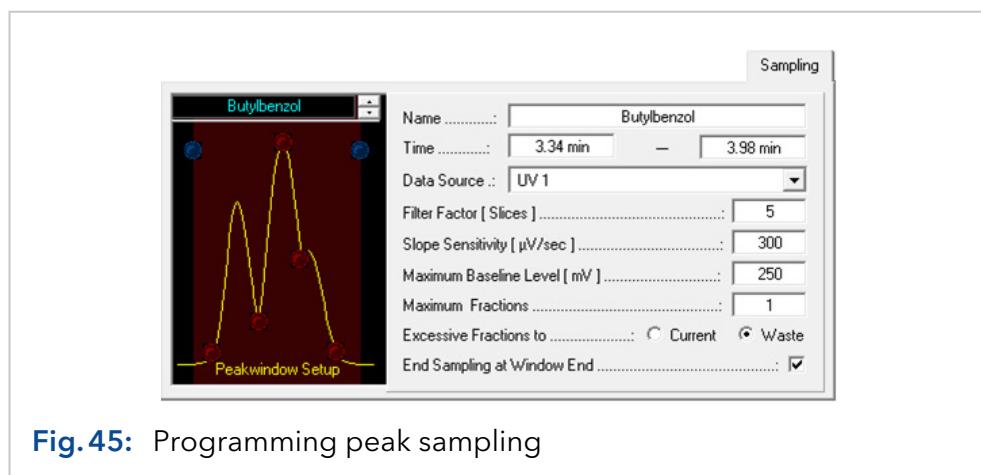

Fig.45: Programming peak sampling

NAME: The name of the peak window can be entered in the *NAME* box.

TIME: The *TIME* boxes are for the time point where the window starts and ends.

DATA SOURCE: In *DATA SOURCE* you can select the data sources for these time windows.

FILTER FACTOR: The *FILTER FACTOR* parameter indicates the number of data points used for the first derivation when calculating the gradient.

SLOPE SENSITIVITY: The *SLOPE SENSITIVITY* indicates the size of the gradient above which the start of a peak is recognised.

MAXIMUM BASELINE LEVEL is used as a threshold value for peak sampling. No peak end is recognised above the value entered.

MAXIMUM FRACTIONS: The *MAXIMUM FRACTIONS* parameter is only relevant to the *DEFINED BY PEAK WINDOW* setting, which is a possible position setting for motorised switching valves. It indicates the maximum number of fractions that can arise in this peak window.

EXCESSIVE FRACTIONS: The *EXCESSIVE FRACTIONS TO* option determines where the fractions that exceed the maximum number of fractions should be pumped. *CURRENT* pumps them in the current position, and *WASTE* pumps them into the waste.

END SAMPLING AT WINDOW END: The *END SAMPLING AT WINDOW END* option indicates whether fractionating should continue after the end of the time period of a peak window, or whether the system should switch to waste.

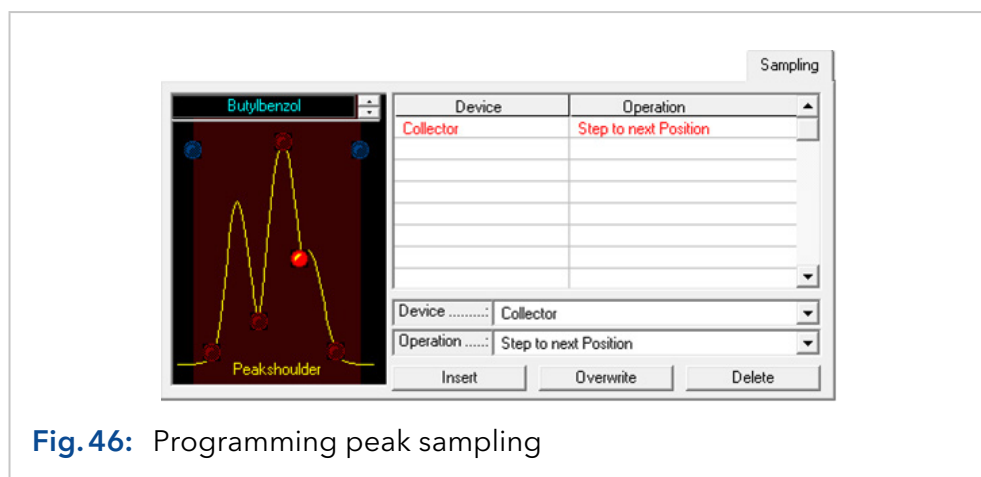

Fig.46: Programming peak sampling

To program peak sampling functions, click on the LED at the desired location. A function table will then appear on the right-hand side, which you can fill in with functions. The selection boxes *DEVICE* and *OPERATION* allow you to select the required function and add it to the time control file with the *Insert* button. The *OVERWRITE* button allows you to overwrite a selected line, and the *DELETE* button deletes it.

The possible peak sampling situations are:

- *PEAK WINDOW START* (blue LED on the left) is the time when a peak window begins.
- *PEAK WINDOW END* (blue LED on the right) is the time when a peak window ends.
- *PEAK START* is the start of a peak as recognised by the peak sampling.
- *PEAK VALLEY* is a dip in a peak recognised by the peak sampling.
- *PEAK SHOULDER* is the shoulder of a peak recognised by the peak sampling.
- *PEAK END* is the end of a peak as recognised by the peak sampling.

The following rules apply to the sensitivity of peak sampling:

- The smaller the data point density (slice width), the faster and more sensitive the peak sampling. However, bear in mind that very small slice widths lead to large results files.
- The smaller the *FILTER FACTOR*, the faster and more sensitive the peak sampling. Bear in mind that the factor range is from 5 to 15, and the value entered must be an odd number.
- The smaller the *SLOPE SENSITIVITY* value, the more sensitive the peak sampling.
- A peak start will be recognized if the measured value exceeds the set value for the *SLOPE SENSITIVITY*. The recognition of the peak start is independent from the *MAXIMUM BASELINE LEVEL*.
- A peak end will only be recognized if the measured value will fall below the set value for the *SLOPE SENSITIVITY* and the *MAXIMUM BASELINE LEVEL*.

6.9 Graphic time control file editor

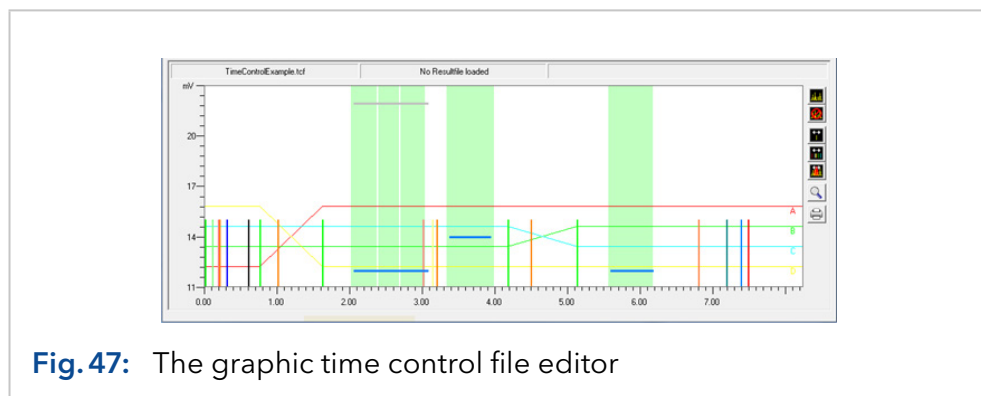

The graphic time control file editor is used to create a graphic presentation of a time control file and allow visual editing. All the functions of the time control file are shown as coloured lines which can be moved horizontally (movement in time) and vertically (changing the threshold value or peak limit) with the mouse. A highlighted function in the table representation of the time control file will flash on the graph. Clicking on a function on the graph will likewise highlight the corresponding line of the table. Peak windows are also represented graphically and can be created and edited with the mouse.

A programmed gradient development is also represented by coloured lines, whereby 0% is the y-axis minimum and 100% is the y-axis maximum.



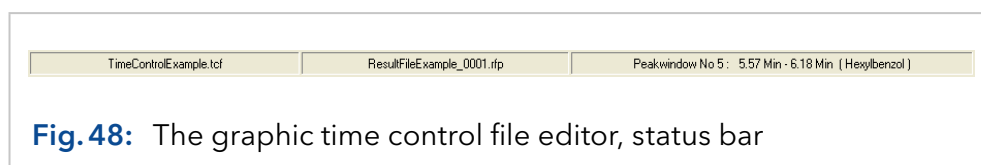

You can load a chromatogram as a background image, which you can then use to adjust the functions of your time control file. The display colours of all the functions can be selected in the graphic time control file editor setup, and any functions you do not want to be shown can be deactivated.





The status bar in the graphic time control file editor shows the name of the time control file loaded, the name of the chromatogram loaded and an information box indicating the following:

- The time control file function over which your mouse cursor is positioned, or which you are moving by means of the *SINGLE FUNCTION MOVING* function.
- The time by which you are shifting the functions when using the *MULTI FUNCTION MOVING* function.
- The name and times of the peak window over which your mouse cursor is positioned when using the *CREATE / EDIT PEAK WINDOW* function.

The graphic time editor tool bar is on the right-hand side of the window. Its functions are listed here in the same order they appear on the screen:

Button	Explanation
	<i>LOAD CHROMATOGRAM</i> opens a chromatogram being used as a background image.
	<i>CLEAR CHROMATOGRAM</i> removes the loaded chromatogram from the graph.
	<i>SINGLE FUNCTION MOVING</i> allows single functions to be moved.
	<i>MULTI FUNCTION MOVING</i> allows multiple functions to be used. To do this, begin by drawing a time window with the left mouse button held down. All the functions within this window can then be moved with the mouse at the same time as long as the left mouse button is held down. The time shift will be adopted as soon as the mouse button is not any longer held down.
	<i>CREATE / EDIT PEAK WINDOW</i> allows peak windows to be created and edited. To create a peak window, simply hold down the left mouse button and draw a new window on screen. When you release the mouse button, you will be asked for the name of the new window. You can edit an existing peak window by moving the mouse cursor over the window. The cursor will change, depending on its position in the window, from an arrow pointing left (on the left-hand side of the window) to an arrow pointing right (on the right-hand side of the window) or an arrow pointing both ways (in the centre of the window). By holding down the left mouse button, you can now extend or move the window to the left and right. If you right-click over a peak window, menu options to rename or delete the window will appear.

Button	Explanation
	<i>ZOOM GRAPHIC</i> is used to enlarge part of a graph. To do this, drag out a window with the left mouse button held down to include the area you wish to enlarge. In order to return to the original graph size, right-click with the mouse.
	<i>PRINT GRAPHIC</i> prints the graph shown.

7. Creating sequence tables

7.1 General

You can open the sequence table editor with the function button or the menu option "Create / Edit Sequence Table" in the main window.

A sequence table processes a sequence of time control files. These time control files may or may not use autosampler injection via the command „Autosampler Inejct“. For time control files with autosampler injection the sample position, number of injections and injection volume of the autosampler can be programmed in the sequence table.

If time control files which use variables are inserted into the sequence table, columns for each variable will be added to the sequence table. For each sequence table line different values can be assigned to the time control file variables.

Time control files incorporating the functions „Restart Time Control File“ and „Load New File“ can not be used in the sequence table. If you want to connect different time control files this can only be done using the sequence table lines.

7.2 Creating a sequence table

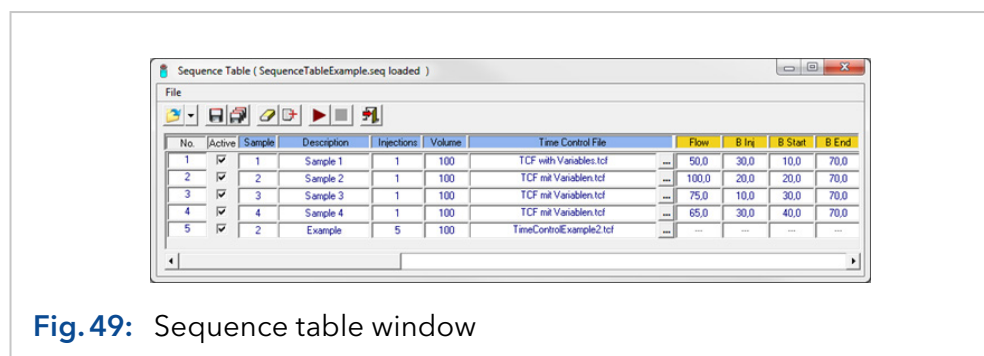







Fig.49: Sequence table window

On the left hand side of the window is the toolbar for the sequence table editor. The functions are listed here in the order which corresponds to the display:

Button	Explanation
	<i>LOAD SEQUENCE TABLE</i> loads an available sequence table into the editor.
	<i>SAVE SEQUENCE TABLE</i> saves the sequence table under its existing file name as .seq file.
	<i>SAVE SEQUENCE TABLE AS ...</i> saves the sequence table under a new name.
	<i>CLEAR SEQUENCE TABLE</i> deletes all entries in all lines of the sequence table.

Button	Explanation
	<i>ADD ROW</i> enters a new empty line into the sequence table.
	<i>EXIT</i> closes the sequence table editor.

After selection of a time control file (.tcf file) in a sequence table line, the columns on the right hand side will be adjusted automatically displaying one column for each variable used in any sequence table line. For each line the variables used in the selected time control file can be entered in the sequence table line. This allows for modification of the time table within the sequence table.

The right mouse click opens a menu with items for copying, inserting and deleting rows into the time table.

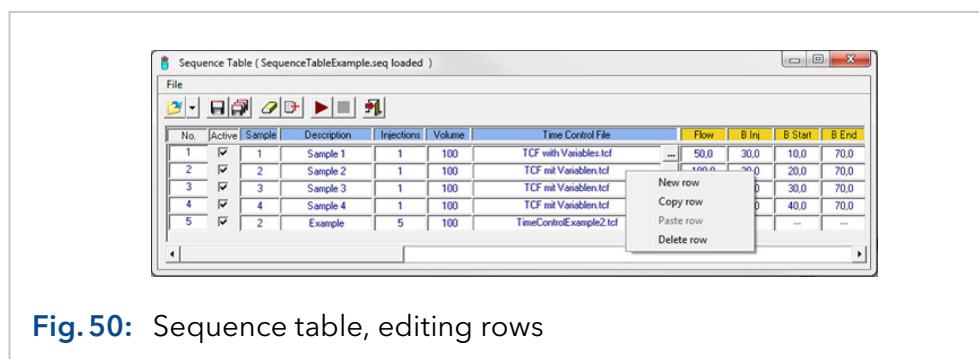



Fig. 50: Sequence table, editing rows

The Menu item „File - Import Autosampler Control File“ opens a dialog window for the selection of an autosampler control file (.acf). The lines of the autosampler control file will be imported into the sequence table.

7.3 Execution of a sequence table

All sequence table lines with the check box in column Active activated will be executed successively. During the execution the current row will be highlighted with a blue arrow and the caption of the sequence table editor window displays the current sequence, injection and runtime. Future lines can be edited during execution.

Button	Explanation
	<i>START SEQUENCE TABLE</i> starts the execution of a sequence table.
	<i>STOP SEQUENCE TABLE</i> or the button „Stop All“ in the main window stops the execution of the sequence table.

No.	Active	Sample	Description	Injections	Volume	Time Control File	Flow	B Inj	B Start	B End
1	<input checked="" type="checkbox"/>	1	Sample 1	1	100	TCF with Variables.tcf	50.0	30.0	10.0	70.0
2	<input checked="" type="checkbox"/>	2	Sample 2	1	100	TCF mit Variablen.tcf	100.0	20.0	20.0	70.0
3	<input checked="" type="checkbox"/>	3	Sample 3	1	100	TCF mit Variablen.tcf	75.0	10.0	30.0	70.0
4	<input checked="" type="checkbox"/>	4	Sample 4	1	100	TCF mit Variablen.tcf	65.0	30.0	40.0	70.0
5	<input checked="" type="checkbox"/>	2	Example	5	100	TimeControlExample2.tcf	---	---	---	---

Fig.51: Sequence table, execution

8. Creating autosampler control files

8.1 General

In the menu option *FILE* in the main window of PurityChrom® you will find the Autosampler Setup:

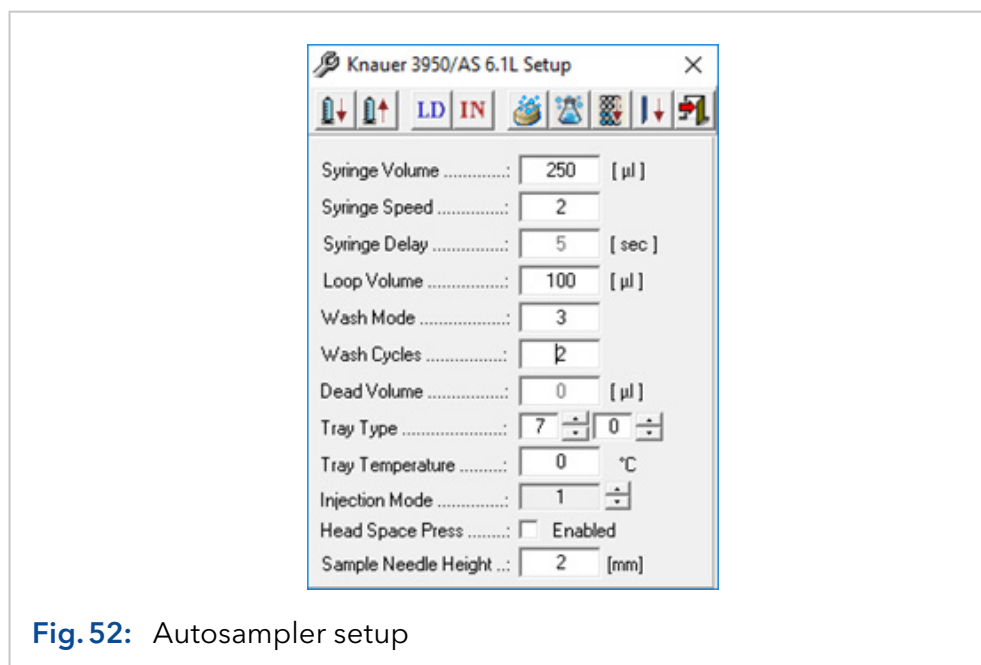









Fig. 52: Autosampler setup

The editor toolbar is in the upper part of the window. The functions are listed in the order they appear on screen:

Button	Explanation
	<i>SYRINGE DOWN</i> moves the syringe into the lower position.
	<i>SYRINGE UP</i> moves the syringe into the upper position.
	<i>INJECTOR LOAD</i> switches the injection valve to the Load position.
	<i>INJECTOR INJECT</i> switches the injection valve to the Inject position.
	<i>NEEDLE WASH</i> initializes the needle washing.
	<i>TRANSPORT WASH</i> initializes the transport fluid washing.
	<i>MOVE TRAY TO FRONT/BACK</i> moves tray.
	<i>EXIT</i> closes window.

The parameters are situated below the editor toolbar:

Menu	Explanation
Syringe Volume	The volume of the autosampler syringe.
Syringe Speed	1: Slow 2: Middle 3: Fast
Syringe Delay	Default at 5 sec., not changeable
Loop Volume	The volume of the sample loop.
Wash Mode	0: Washing cycle is turned off 2: Between vials 3: Between injection
Wash Cycles	Number of wash cycles (1 - 3 times).
Dead Volume	Not changeable for KNAUER autosamplers.
Tray Type	0: Wellplate 96 low 1: Wellplate 96 high, 2: Wellplate 384 low 3: 48 vials 4: 12 vials 5: 108 vials* 6: 84 + 3 vials* 7: 30 vials Prep* Note: Please note, that vials 86 and 87 cannot be used in rack 6 (84+3). Vial 85 will be used for transport wash when ini entry „TransportLiquid=1“ is set.
Tray Temperature	0 °C: off Sample tray cooling for KNAUER 3950/AS 6.1L With cooling option: 4 - 40 °C
Injection Mode	0: None 1: Partial Loop Fill 2: Full Loop 3: Microliter Pickup

Menu	Explanation
Head Space Press	<p>Activate the <i>HEAD SPACE PRESSURE</i> option to support the sample transport to the sample loop. This prevents any negative pressure that might occur in the vial when the sample is aspirated, from influencing the injection volume.</p> <p>Note: The accuracy and reproducibility of the autosampler may decrease if headspace pressure is switched off.</p>
Sample Needle Height	Select a distance between 2 and 6 mm

Partial Loop Fill / Microliter Pickup: maximum injection volume is 50 % of the sample loop volume.

Please see chapter 23.3 on page 117 for combinations of different trays and the numeration of each vial.

The function button and menu option *CREATE / EDIT AUTOSAMPLER CONTROL FILE*  in the main window opens the autosampler control file editor. The full version of PurityChrom is needed to use an autosampler.

An autosampler control file works on the principle of a series of time control files, each of which is allocated an automatic sample injection. The command for the sample injection is programmed into the corresponding time control file with the command *INJECT*.

During injection, the time progression is paused (*TIME CONTROL HOLD*). The parameters for the injections are programmed into the autosampler control file. These parameters include the vial numbers, the number of injections per vial, the injection volume and the column oven temperature. However certain values for the time control file can also be pre-set. To do this, the parameter *AS* must be entered in the time control file. Then the parameter *AS* will act as a variable and obtain its values from the current line of the autosampler control file.

Possible commands include:

- *SOLVENT* (eluent composition for the pump)
- *FLOW RATE* (flow rate for the pumps)
- *THRESHOLD* (level of a programmed threshold value)
- *WAVELENGTH* (UV detector wavelength)
- *LIMITER VALUE* (maximum size of the fractions obtained)

The running time programmed into the autosampler control table determines the time after which the current or a new time control file is started for the next injection. The time progression of an autosampler control file determines which time control file is started and how long it runs. Restarting a time control file will only occur for as long as further injections take place. After the last injection, the corresponding time control file will therefore continue running until the system stops.

This function can be useful if you program a *STOP ALL* in the time control file after the programmed running time of the autosampler control file.

For as long as there are further injections waiting, this command will not be carried out, because the time control file will always restart first. It is only after the last injection the time control file will reach this line of the program, and the system will stop automatically.

Autosampler injections can be programmed either as single injections or as a sequence. The sample identifiers of the individual vials can be entered in a sample table. For each injection, the identifier corresponding to the sample number will be read from this table.

8.2 Creating an autosampler control file

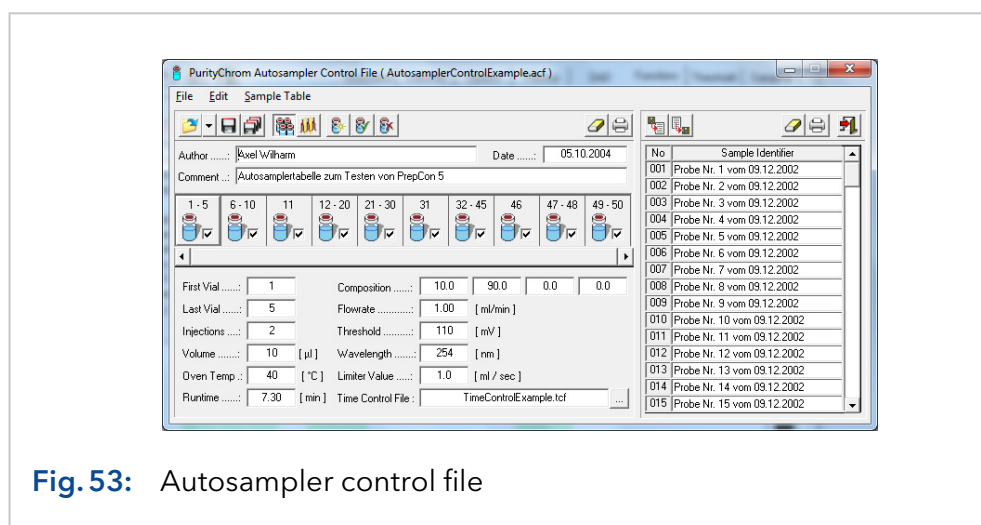













Fig. 53: Autosampler control file

The editor toolbar is in the upper part of the window. The functions are listed in the order they appear on screen:

Button	Explanation
	<i>OPEN AUTOSAMPLER CONTROL FILE</i> loads an existing autosampler control file into the editor. The possible file types to be loaded are <i>AUTOSAMPLER CONTROL FILE (*.acf)</i> or <i>RESULT FILE (*.rpf)</i> . <i>RESULT FILE</i> allows to load an autosampler control file from a result file.
	<i>SAVE AUTOSAMPLER CONTROL FILE</i> saves the autosampler control file under its existing name.
	<i>SAVE AUTOSAMPLER CONTROL FILE AS ...</i> saves the autosampler control file under a new name.
	<i>INJECTION PARAMETER</i> opens the panel with the input fields of the Injection Parameter.
	<i>STACKED INJECTION PARAMETER</i> opens the panel with the input fields of the Stacked Injection Parameter (not yet supported by KNAUER autosamplers).

Button	Explanation
	<i>STACKED INJECTION ENABLE / DISABLE</i> activates or deactivates the stacked injection-function of the autosampler control file (not yet supported by KNAUER autosamplers).
	<i>INSERT AUTOSAMPLER SEQUENCE</i> adds the autosampler sequence in the editor box to the autosampler control file.
	<i>OVERWRITE AUTOSAMPLER SEQUENCE</i> overwrites the highlighted autosampler sequence with the one in the editor box.
	<i>DELETE AUTOSAMPLER SEQUENCE</i> deletes the highlighted autosampler sequence.
	<i>CLEAR ALL</i> deletes the contents of the autosampler control file. In order to prevent accidental deletion, this function is only carried out after confirmation.
	<i>PRINT AUTOSAMPLER CONTROL FILE</i> opens a printer dialogue box to print out the autosampler control file.
	<i>EXIT</i> closes the editor.

A name and a comment can be entered on the autosampler control file in the Author and *COMMENT*. The date is generated automatically when the file is saved.

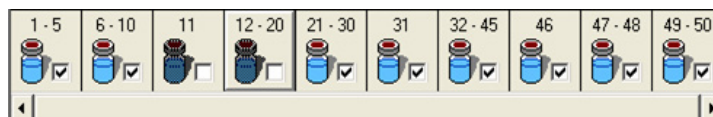

Fig. 54: Autosampler control file, sequence bar

The sequence bar shows all the autosampler sequences. If there are more than 10 sequences, the sequence bar can be scrolled using the scroll bar underneath. Each sequence is shown with the vial numbers programmed. The sequence icons can be ticked to activate or deactivate them for processing. In case of an assumed interrupted run, this function can be used to deactivate the sequences that have already been processed.

Beneath the sequence bar is the editor box with entry boxes for a sample sequence. The parameters to be entered are the following:

FIRST VIAL is the number of the first vial in a sample sequence.

LAST VIAL is the number of the last vial in a sample sequence. If it is injected only from one vial, enter the same number in *FIRST VIAL* and *LAST VIAL*.

INJECTIONS indicates the number of injections per vial.

VOLUME indicates the injection volume in μl .

OVEN TEMP indicates the temperature of the column oven.

RUNTIME indicates the running time after which the current or a new time control file will begin with the next injection. The running time should always be shorter than the function *STOP ALL* in the corresponding time control file that still has to be carried out. For multiple injections, use the function *STOP CHROMATOGRAM* to restart the data recording. A minimum time difference needs to be programmed of 0.2 min between the function *STOP CHROMATOGRAM* in the time control and the *RUNTIME* of your autosampler. Furthermore a minimum time gap of 0.2 min has to be programmed between the *RUNTIME* of the autosampler and the function *STOP ALL* in the time control file.

SOLVENT indicates an eluent composition entered in the solvent lines of a time control file with the eluent composition *AS* as a parameter.

FLOW RATE indicates a flow rate entered in the flow rate lines of the time control file with the flow rate parameter *AS*.

THRESHOLD indicates a threshold level entered in the threshold lines of the time control file with the threshold value *AS* as a parameter.

WAVELENGTH indicates a wavelength entered in the wavelength lines of the time control file with the wavelength parameter *AS*.

LIMITER VALUE indicates a maximum volume entered in the limiter lines of the time control file with the maximum volume parameter *AS*.

TIME CONTROL FILE indicates the time control file which is started for every injection in this sequence.

8.3 Stacked injection



Note: Stacked injection is not supported with KNAUER 3950 / AS 6.1L.

The function *STACKED INJECTION* allows for multiple nested injections of identical probes in order to save solvents and time. During the elution time of one sample the following sample is already injected onto the column. If the function *STACKED INJECTION* is activated, all entries of the sample table will be executed within one run. In the select list under the item *INJECTION BY...* one can choose whether samples are automatically injected by an autosampler or by a valve. In case of injection by valve the main pump aspirates sample and switches the injection valve into position 2 until the required amount of sample is pumped into the system.

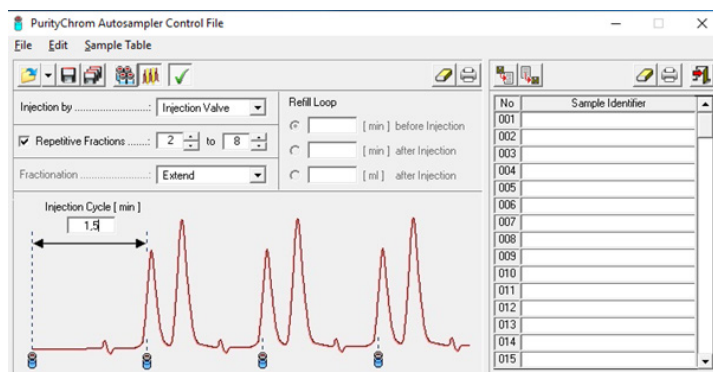

Fig. 55: Stacked injection

The Parameter *REPETITIVE FRACTIONS* defines the specific fractions used in one cycle. After the final fraction is reached the cycle is repeated. The Fractionation parameter will define if the fractionation event determined in the time control file is extended (e.g. in the case of a threshold) or is copied (e.g. for a peak window).

In case of injections using an autosampler the parameter *REFILL LOOP* defines at what time the sample loop is refilled. Possible options are *TIME BEFORE INJECTION*, *TIME AFTER INJECTION* and *VOLUME AFTER INJECTION*.

Zeit [Min]	Funktion	Parameter
0.00	Composition Major Pump	100.0 , 0.0 , 0.0 , 0.0
0.00	Flowrate Major Pump	100.00 ml/min
0.15	Autosampler Inject	
0.20	Start Chromatogram	Channel 1 (200 ms)
1.00	Threshold	4.90 min / 25.00 mV
6.00	Stop Chromatogram	All started Channels
6.10	Stop all	

Fig. 56: Initial time table

Zeit [Min]	Funktion	Parameter
0.00	Composition Major Pump	100.0 , 0.0 , 0.0 , 0.0
0.00	Flowrate Major Pump	100.00 ml/min
0.15	Autosampler Inject	
0.20	Start Chromatogram	Channel 1 (200 ms)
1.00	Threshold	20.29 min / 25.00 mV
1.86	Autosampler Inject	
3.57	Autosampler Inject	
5.28	Autosampler Inject	
6.99	Autosampler Inject	
8.70	Autosampler Inject	
10.41	Autosampler Inject	
12.12	Autosampler Inject	
13.83	Autosampler Inject	
15.54	Autosampler Inject	
21.39	Stop Chromatogram	All started Channels
21.49	Stop all	

Fig.57: Extended time table after additional injections

8.4 Creating a sample identifier table





No	Sample Identifier
001	Sample No 1 , 09.12.2002
002	Sample No 2 , 09.12.2002
003	Sample No 3 , 09.12.2002
004	Sample No 4 , 09.12.2002
005	Sample No 5 , 09.12.2002
006	Sample No 6 , 09.12.2002
007	Sample No 7 , 09.12.2002
008	Sample No 8 , 09.12.2002
009	Sample No 9 , 09.12.2002
010	Sample No 10 , 09.12.2002
011	Sample No 11 , 09.12.2002
012	Sample No 12 , 09.12.2002
013	Sample No 13 , 09.12.2002
014	Sample No 14 , 09.12.2002
015	Sample No 15 , 09.12.2002

Fig.58: Sample identifier table

The sample identifier table is located on the right hand side of the editor. The sample numbers are displayed in the first column of the table, and the sample identifiers in the second column. The sample identifiers can be written directly into the table.

Before each injection, the identifier corresponding to the sample number is read from this table and used as the *SAMPLE IDENTIFIER*. The number of rows in the table can be set in the file PurityChrom .ini with the command *[MAXIMUMSAMPLES]*. 100 sample identifiers are possible as standard.

Above the table is the sample identifier table toolbar. Its buttons have the following functions:

Button	Explanation
	<i>IMPORT SAMPLE TABLE</i> imports a sample identifier table from a text file.
	<i>EXPORT SAMPLE TABLE</i> exports the sample identifier table as a text file.
	<i>CLEAR SAMPLE TABLE</i> deletes the content of the sample identifier table. In order to avoid accidental deletion, this function will only be carried out after confirmation from the user.
	<i>PRINT SAMPLE TABLE</i> opens a printer dialogue box to print out the sample identifier table.

9. Control file visualisation

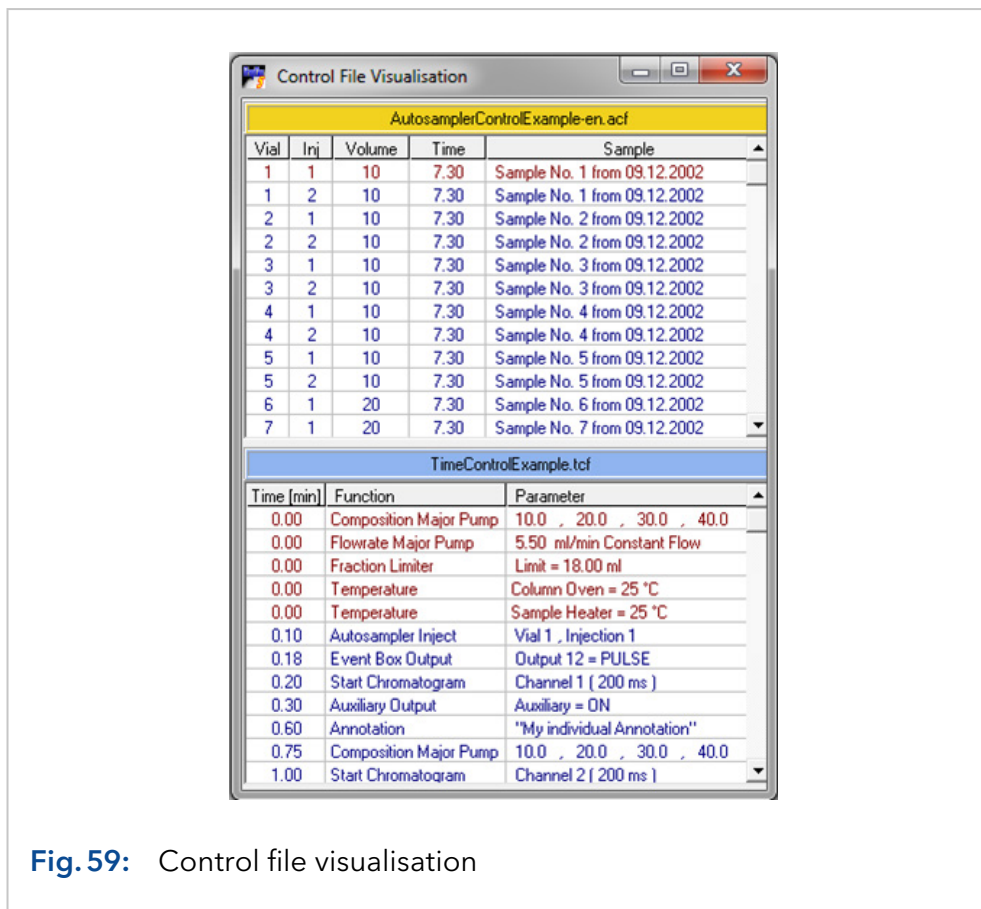



Fig. 59: Control file visualisation

The function button and the menu option *CONTROL FILE VISUALISATION*  in the main window open the window where you can visualise the time and autosampler control files. When you are running a time control file, it will be displayed in the form of a table. All the lines that have already been worked through will be displayed in red, and those still to come will be in blue. The blue line above the table shows the name of the time control file loaded.

When you are running an autosampler control file, another table shows all the injections in the sequences programmed. Here also, the injections that have already been made are in red and those still to come are in blue. The columns of the table show you the number of each vial, the injection number, the sample volume injected, the running time of the time control file and the sample identifier. The yellow field above this table shows the name of the autosampler control file. The tables automatically scroll down in such a way that the current line is always visible.

10. Data recording (analysis)

10.1 General

The function button and the menu option *CHROMATOGRAM*  in the main window opens the chromatogram window. The first area is data recording (Analysis).

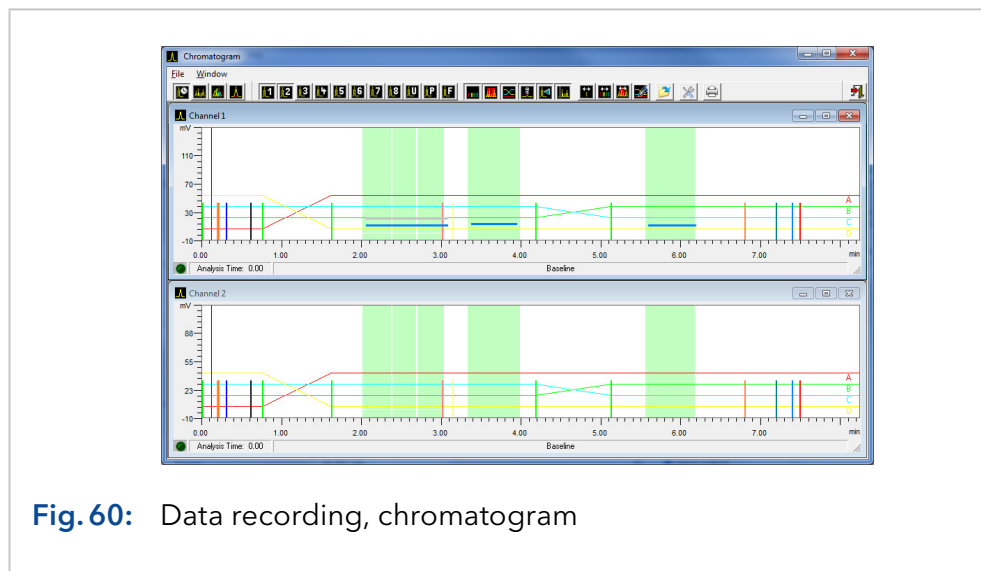











The data-recording window is used to display and record analogue signals. The requirement for this is an analogue/digital converter card in your PC. Up to 8 analogue signals can be recorded at once. The automatic peak sampling can only work with these analogue signals.







Data recording is started in the time control file with the command *START CHROMATOGRAM* and stopped with *STOP CHROMATOGRAM*. Chromatograms can be started simultaneously or with a delay.

While a time control file is running, the graphic display of the time control file, the current chromatogram trace, the programmed peak windows, the gradient and the current chromatogram labels are displayed in the data recording windows. Just like in the graphic time control file editor, you have the possibility to edit time control file functions and peak windows in the data recording windows. These changes take effect on the current run and can also be saved in the time control file loaded. This means you have the possibility of intervening in a process *ONLINE*.

The buttons 100% Solvent A-D and flowrate in the main window can be enabled during a time control run by changing the PurityChrom.ini-file [Pumps → Parameter Change=1] (see chapter 23 on page 103). This enables you to change the flowrate and gradient composition during the run. All changes with the exception of changed fraction collector or fraction valve positions which were performed during a run are recorded and can be viewed in *VIEW PROTOCOL* by opening the chromatogram in the reconstruction window (see chapter Function Buttons in the Reconstruction Window).

10.2 Function buttons

Button	Explanation
	<p><i>CHANNEL...</i> is used to open or close a data channel window. Only the buttons for the channels that can be selected are shown. The U button belongs to a user-defined channel (see chapter 4.6 on page 17). Data channels which are programmed into a time control file are automatically opened upon loading. If no data recording is active, the data track selected runs in base line mode, i.e. from the left to the right edge in about 8 minutes as an endless loop. Data recording is started with the time control file command <i>START CHROMATOGRAM</i> and stopped with the command <i>STOP CHROMATOGRAM</i>.</p>
	<p><i>PRESSURE CHANNEL</i> shows the pressure data of the pump. This channel can be used like the data channels described above.</p>
	<p><i>FLOW RATE CHANNEL</i> shows the actual value of the flow rate performed by the major pump system. It can be used like the data channels described above. It is especially useful when using the option <i>PRESSURE LIMIT</i> in a time control file programming. Then it will show when and in which intensity the automatic flow rate control was active.</p>
	<p><i>SPECTRUM CHANNEL</i> is used to show or hide the spectrum window of the DAD.</p>
	<p><i>SHOW FUNCTIONS</i> is used to show or hide the time control file functions. When the functions are hidden, the contents of the window are scaled to fit the area of the data recording.</p>
	<p><i>SHOW PEAK WINDOWS</i> is used to show or hide the peak windows.</p>
	<p><i>SHOW GRADIENT</i> is used to show or hide the programmed gradients.</p>
	<p><i>SHOW ANNOTATIONS</i> is used to show or hide the current annotations.</p>
	<p><i>SHOW LAST CHROMATOGRAM</i> automatically loads the last chromatogram as a background image in the data channel window.</p>
	<p><i>SHOW ELAPSED TIME LINE</i> is used to show or hide the vertical line indicating the elapsed time.</p>

Button	Explanation
	<i>SINGLE FUNCTION MOVING</i> enables you to move single functions (see chapter 6.9 on page 46). Changes take immediate effect in the current run, and after deselecting these functions you will be asked if they should be saved in the time control file as well.
	<i>MULTI FUNCTION MOVING</i> enables you to move multiple functions (see chapter 6.9 on page 46). Changes take immediate effect in the current run, and after deselecting these functions you will be asked if they should be saved in the time control file as well.
	<i>CREATE / EDIT PEAK WINDOW</i> allows you to create and edit peak windows (see chapter 6.9 on page 46). Changes take immediate effect in the current run, and after deselecting these functions you will be asked if they should be saved in the time control file as well.
	<i>EDIT GRADIENT</i> opens a window where you can edit the running Gradient. Changes take immediate effect in the current run, and after closing the window you will be asked if they should be saved in the time control file as well.
	<i>LOAD LAST CHROMATOGRAM</i> is used to load the last chromatogram manually, as a background image for the data channel window.
	<i>CHANNEL SETUP</i> opens the window with the settings for the individual data channels. The different parameters will be described in chapter (see chapter 10.4 on page 65).
	<i>AUTOMATIC PRINT</i> activates or inactivates the automatic printing of the report after the recent run.

10.3 Status bar

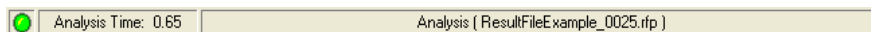





Fig. 61: Data recording, status bar

The data recording status is displayed with a graphic in the left-hand box of the status bar. The meaning of the symbols is as follows:

Status bar	Explanation
	<i>BASELINE</i> (Baseline is displayed)
	<i>READY</i> (data channel is in use, but has not yet started)
	<i>CHROMATOGRAM RUNNING</i> (data recording is active)
	<i>CHROMATOGRAM FINISHED</i> (data recording has finished)

The central box shows the chromatogram running time, and the right-hand box shows the current status, with the name of the results file.

10.4 Data channel settings

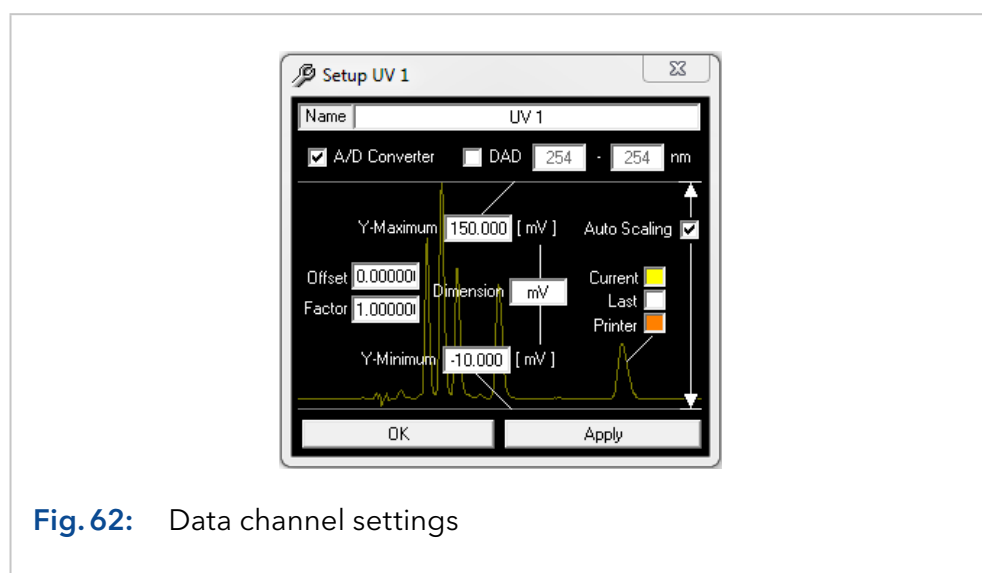

Fig. 62: Data channel settings

The window always shows the data of the selected channel, i.e. the analysis window in focus. *NAME*: You can change the name of the channel in the *NAME* window.

You can use the options *A/D CONVERTER*, *DAD* or *MS* to determine the data source of the channel.

A/D CONVERTER: For the data of the A/D conversion cards or UV detectors.

DAD: For the data of the DAD

MS: For the data of the MS

OFFSET: The *OFFSET* parameter is used to compensate for a detector offset. The value entered will be added to the analogue signal, and can be positive or negative.

FACTOR: The *FACTOR* parameter is used to correct the size of the signal indicated. A factor of 1 shows the analogue signal at its original size.

Y-MAXIMUM and *Y-MINIMUM*: The *Y-MAXIMUM* and *Y-MINIMUM* values set the scale of the y-axis.

AUTO SCALING: The *AUTO SCALING* option automatically corrects the scaling when these values exceed or drop below the corresponding maximum or minimum signal.

DIMENSION: You can set the measurement unit of each channel in the *DIMENSION* box.

CURRENT, *LAST* or *PRINTER*: Clicking on the *CURRENT*, *LAST* or *PRINTER* box opens a colour selection dialogue, which you can use to set the colour of each chromatogram trace. *CURRENT* is the colour of the current chromatogram and *LAST* is the colour of the last chromatogram, which is displayed if you use the *SHOW LAST CHROMATOGRAM* function and *PRINTER* is the colour of the printed chromatogram.

The *APPLY* button applies the settings, and the *OK* button closes the window at the same time.

Choose the type of the displayed spectrum in the setup window for the DAD spectrum under *SPECTRUM TYPE*.

DARK CURRENT is the remaining current without exposing the diode array.

LAMP SPECTRUM: The *LAMP SPECTRUM* is the measured spectrum of the diode array minus the dark current.

REFERENCE SPECTRUM: The *REFERENCE SPECTRUM* is a saved lamp spectrum. A *REFERENCE SPECTRUM* can be set manually by the *SET REFERENCE SPECTRUM* function button . Otherwise it is set automatically when PurityChrom is started.

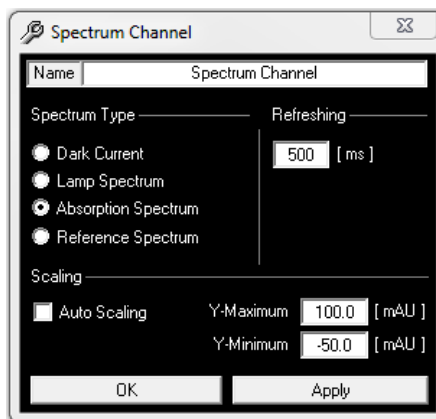

Fig. 63: Data channel settings, spectrum channel

ABSORPTION SPECTRUM: The *ABSORPTION SPECTRUM* of the DAD is the logarithm of the reference spectrum minus the logarithm of the actually measured lamp spectrum.

REFRESHING: The *REFRESHING* parameter defines after which time the spectrum display is actualized.

Y-MAXIMUM and *Y-MINIMUM:* The *Y-MAXIMUM* and *Y-MINIMUM* values define the scaling of the y-axis.

AUTO SCALING: The *AUTO SCALING* option automatically fits the scaling according to the signal maximum and minimum.

11. Displaying chromatograms (reconstruction)

11.1 General

The function button and the menu option *CHROMATOGRAM*  in the main window open the chromatogram window. The second area displays the chromatograms (reconstruction).

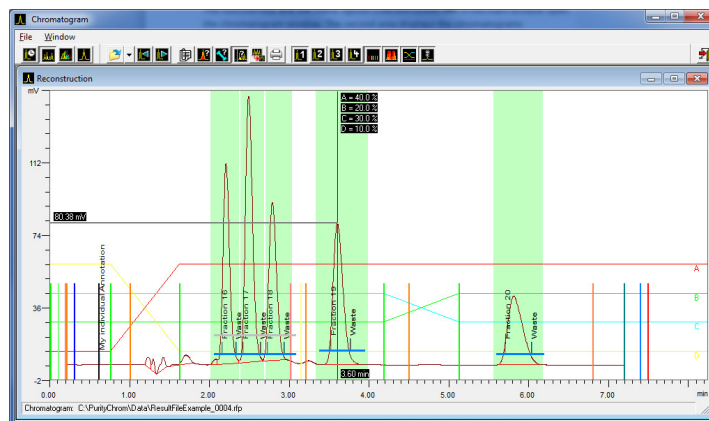

Fig. 64: Displaying chromatograms, general

You can load and display result files in the reconstruction window. Chromatograms, time control file functions, peak windows, gradients, chromatogram labels and the protocol of the run can all be displayed. The chromatograms can be displayed singly or, in the case of multiple channel data recording, superimposed.

To enlarge the display of certain areas, you can drag out a zoom window by holding down the left mouse button. When you release the mouse button, the display will automatically zoom in on this area. You can repeat this process up to the maximum zoom level. To return to the original size, click on the chart with the right mouse button.

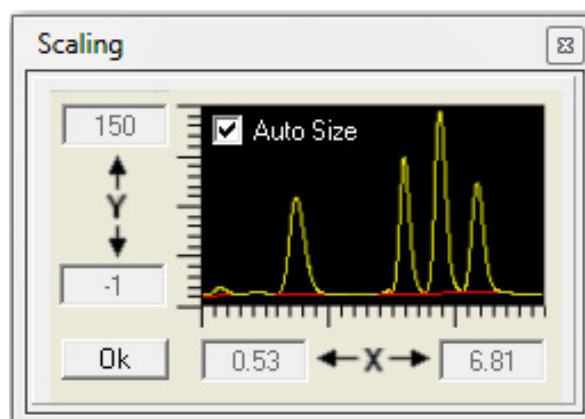











Fig. 65: Displaying chromatograms, scaling

Double-clicking on the chromatogram scaling opens a window, in which you can fix the scaling by values. After this, the scaling will be displayed highlight. The option *AUTO-SIZE* automatically fits the chromatogram in the reconstruction window.

The status bar at the bottom of the window shows the path and name of the result file loaded. If you move the mouse cursor over a time control file function, the time and parameter values of this function will be displayed in the status bar.

11.2 Function buttons

Button	Explanation
	<i>OPEN RESULT FILE</i> opens a results file (*.rfp). Temporary results files (*(H).tmp) can also be opened. The temporary results files are created at the end of a method run and usually are deleted after they have been summarized to the results file. On an unsuspected end of a run such as power failure or system crash the temporary files are still existing. On opening a temporary results file a normal results file is automatically created. The maximum loss of data will be 100 data points. This corresponds to a loss of 50 seconds of chromatographic time when using a slice width of 500 ms.
	<i>PREVIOUS RESULT FILE</i> loads the result file that comes before the loaded file in the order of their names.
	<i>NEXT RESULT FILE</i> loads the result file that comes after the loaded file in the order of their names.
	<i>VIEW PROTOCOL</i> opens a window that displays the run protocol ordered by time. All changes which were performed during the run are listed here.
	<i>VIEW FRACTION TABLE</i> opens a table with all fractions produced in the run of the loaded chromatogram.
	<i>VIEW PEAK RESULTS</i> opens the window with the display of the integration results in table form.
	<i>VIEW COLUMN COEFFICIENTS</i> opens the window with the display of the column coefficients in table form. To calculate the capacity enter the column dead Time in the field <i>COLUMN DEAD TIME</i> . Instead of the asymmetry the tailing factor can be calculated as well. Therefore the PurityChrom.ini-file [IntegrationPresets → TailingFactor=1] (see chapter 23 on page 103) has to be modified.

Button	Explanation
	<p><i>VIEW PEAK VALUE</i> is used to register the peak values and gradient composition. After selecting this function, cross hairs will appear on the graph, which you can move along the chromatogram trace. The time, intensity and gradient composition will be displayed on the cross hair lines. In a multiple channel result file, only one chromatogram can be selected to register peak values. At any time in the chromatogram the appropriate spectrum can be shown when the chromatogram is recorded by a DAD detector and a DAD result file (2D data) exists. Click with the right mouse button in the chromatogram and choose <i>SHOW SPECTRUM</i>. A new window appears showing the spectrum belonging to the chosen time. This operation can be repeated by clicking again with the right mouse button or by moving the mouse with pressed right button.</p>
	<p><i>EXPORT CHROMATOGRAM</i> is used to export one or more chromatograms. The export formats can be selected in the file selection window as file types. Possible export formats are <i>COMMA SEPARATED VALUE FILE</i> for export to Excel, <i>AIA/ANDI FILE</i> for export in Andi file format or <i>SLICEFILE</i> for export to ChromStar.</p>
	<p><i>PRINT RESULT FILE</i> is used to print the result file loaded. After selecting this function, a window opens in which you activate or deactivate elements of the results data to appear on the printout (see chapter 6.2.5 on page 33).</p>

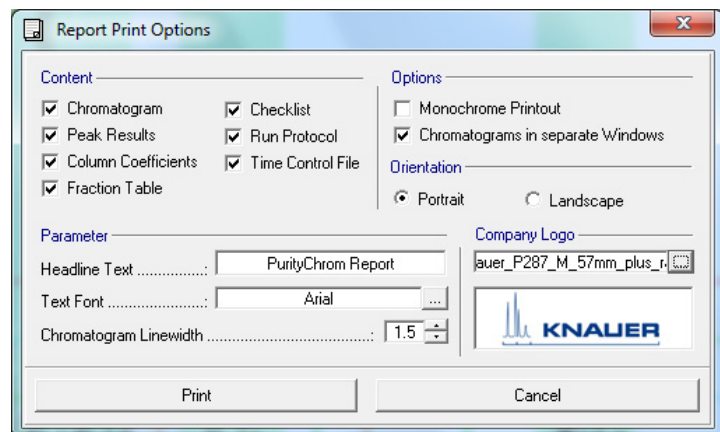







Fig. 66: Displaying chromatograms, report print options

Button	Explanation
	<i>SHOW CHANNEL ...</i> shows or hides each chromatogram. Hidden chromatograms are not displayed on screen, and they do not appear on the printout either.
	<i>SHOW FUNCTIONS</i> shows or hides the time control file functions. When the functions are hidden, the window contents are scaled to fit the area of the data recording.
	<i>SHOW PEAK WINDOWS</i> shows or hides the peak windows.
	<i>SHOW GRADIENT</i> shows or hides the gradient.
	<i>SHOW ANNOTATIONS</i> shows or hides the annotations.

12. Comparing chromatograms (compare)

12.1 General

The chromatogram window is opened in the main window via function button or menu procedure *CHROMATOGRAM* . The third function button opens the compare chromatograms window (COMPARE).

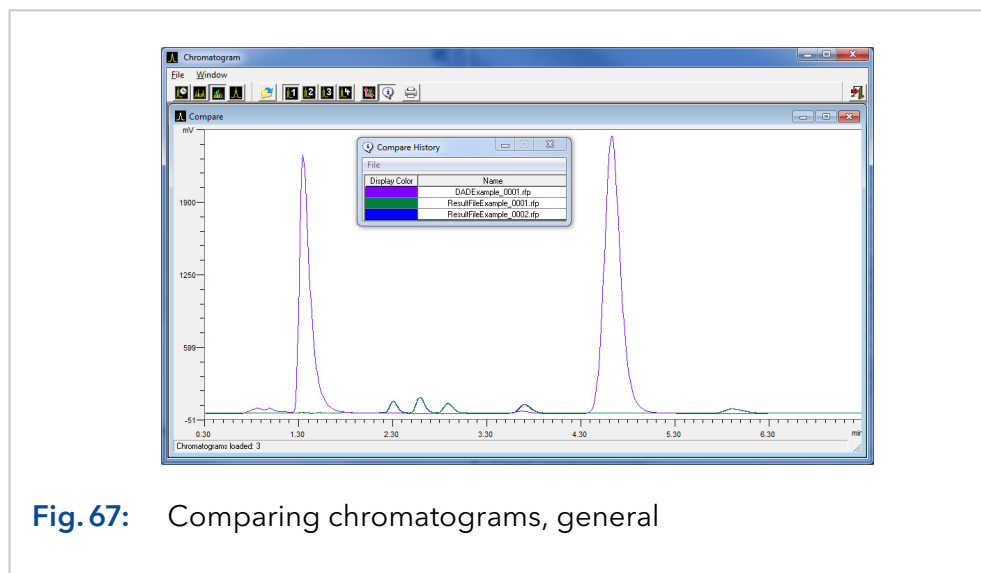

Fig. 67: Comparing chromatograms, general

Several result files (.rfp) can be loaded. Only the chromatogram is displayed.

A zoom window can be opened by pressing the left mouse button and dragging the mouse. On depressing the mouse button the zoomed window is shown. This procedure can be repeated until a maximum of magnification is reached. By clicking the right mouse button the original size is restored.

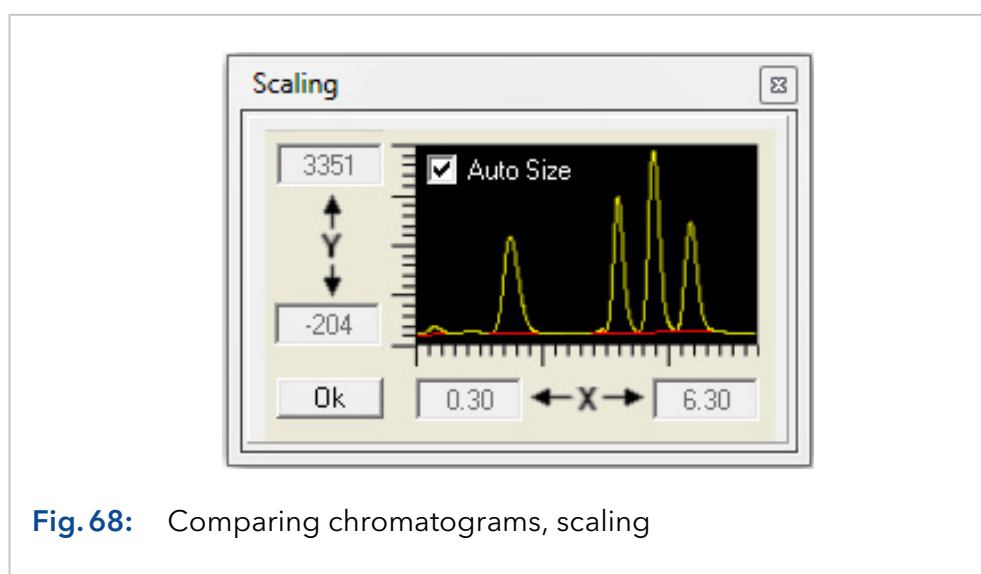







Fig. 68: Comparing chromatograms, scaling

Double-clicking on the chromatogram scaling opens a window, in which you can fix the scaling by values. After this, the scaling will be displayed highlight. The option AUTO-SIZE automatically fits the chromatogram in the compare window.

The status bar in the bottom shows the number of loaded result files.

12.2 Function buttons

Button	Explanation
	<i>OPEN RESULTFILES</i> opens one or more result files. Multiple selection of several result files can either be done by using the STRG-button or the SHIF-button and the result files simultaneously.
	<i>CHANNEL ...</i> chooses the channel the chromatograms of which are to be shown in the Compare window.
	<i>CHROMATOGRAM OFFSET</i> is used to offset the loaded Chromatograms. By using the cursor buttons the chromatograms will be moved on x axis and y axis. The status bar shows the offset in pixel.
	<i>COMPARE HISTORY</i> opens a window which shows the list of the result files and the corresponding colors. The column <i>DISPLAY COLOR</i> shows the color and the column <i>NAME</i> shows the name of the result file.
	<i>PRINT RESULTFILES</i> prints out the graphic representation of the loaded result files and the color references.

Using the menu procedure *FILE* and *DISPLAY COLOR* the colors in the display can be chosen. By using *PRINTER COLOR* the colors in the print-out can be chosen. A double click in one of the colors opens a dialog box in which the color can be changed.

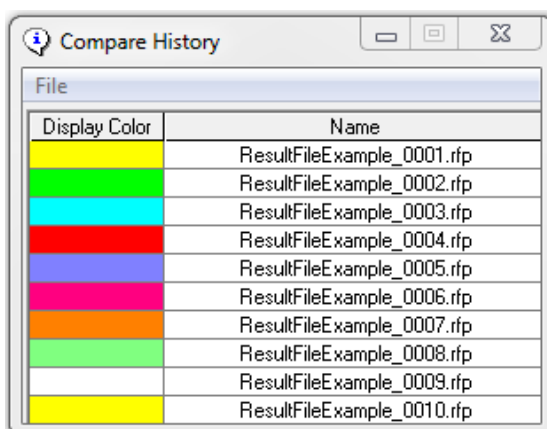











Display Color	Name
	ResultFileExample_0001.rfp
	ResultFileExample_0002.rfp
	ResultFileExample_0003.rfp
	ResultFileExample_0004.rfp
	ResultFileExample_0005.rfp
	ResultFileExample_0006.rfp
	ResultFileExample_0007.rfp
	ResultFileExample_0008.rfp
	ResultFileExample_0009.rfp
	ResultFileExample_0010.rfp

Fig. 69: Comparing chromatograms, compare history

13. Reintegrating chromatograms

13.1 General

The function button and the menu option *CHROMATOGRAM*  in the main window open the chromatogram window. The fourth area displays the reintegration of chromatograms. You can reintegrate the chromatograms from result files in the integration window.

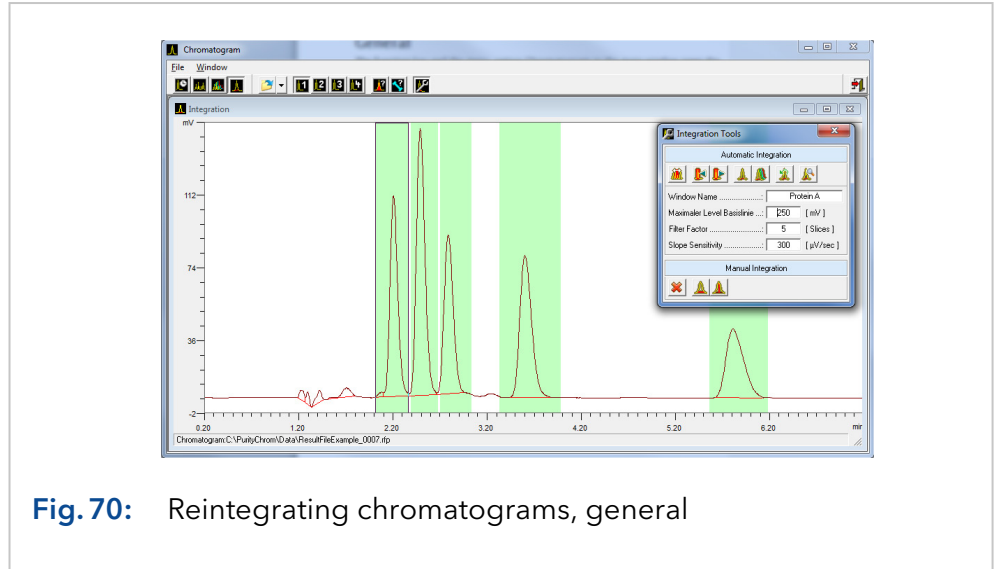

Fig. 70: Reintegrating chromatograms, general

The chromatograms can be reintegrated singly, or collectively in the case of multiple channel data recording. Once reintegration has been carried out, it is saved automatically. The original integration remains in the result file, so that you always have the possibility of reverting to the original.

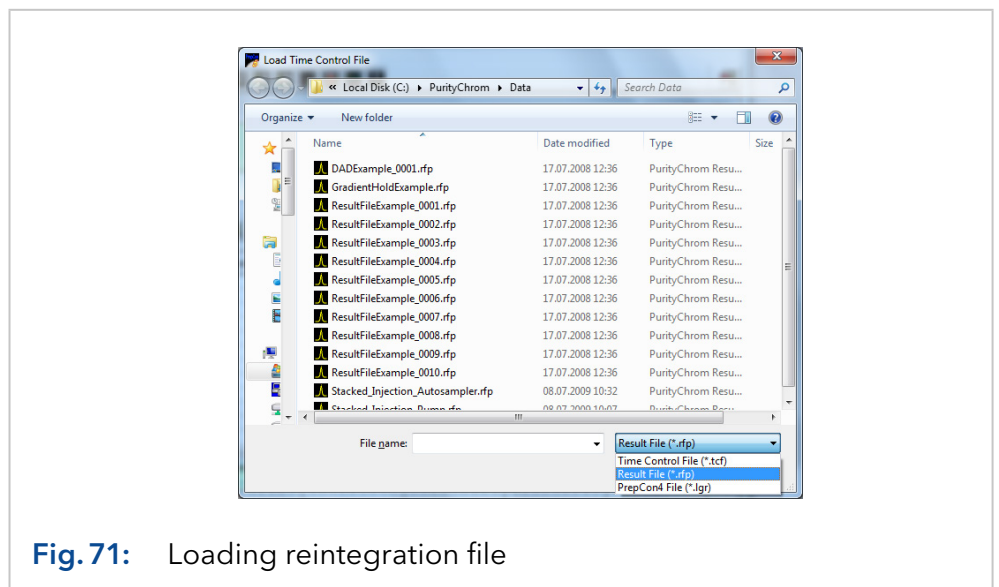





Fig. 71: Loading reintegration file

Reintegration allows you to optimise the integration of your chromatograms later on. If you load a reintegrated results file (.rfp file, see figure) into the time control file editor (instead of a time control file), the program will recognise the reintegration and ask you if you want to load the reintegration parameters. This time control file will be identical to the run completed, but will contain the integration parameters of the reintegration. You can then save this time control file under a new name, or overwrite the old file.

To enlarge the display of certain areas, you can drag out a zoom window by holding down the left mouse button. When you release the mouse button, the display will automatically zoom in on this area. You can repeat this process up to the maximum zoom level. To return to the original size, click on the chart with the right mouse button.

The status bar at the bottom of the window shows the path and name of the result file loaded.

13.2 Function buttons

Button	Explanation
	<i>OPEN RESULT FILE</i> opens a result file.
	<i>CHANNEL ...</i> is used to select the chromatogram shown in the reintegration window.
	<i>VIEW PEAK RESULTS</i> opens the window with the display of the integration results in table form.
	<i>INTEGRATION TOOLS</i> opens the window with the function buttons and parameter boxes for reintegration.

The Integration Tools window contains the tools needed for reintegration. The integration parameters are saved with the peak windows. Carrying out a reintegration always concerns the part of the chromatogram within the peak window selected.

Outside of the peak windows the default parameters are applied as defined in PurityChrom.ini (see chapter 23.1 on page 103). The buttons in the tools window have the following functions:

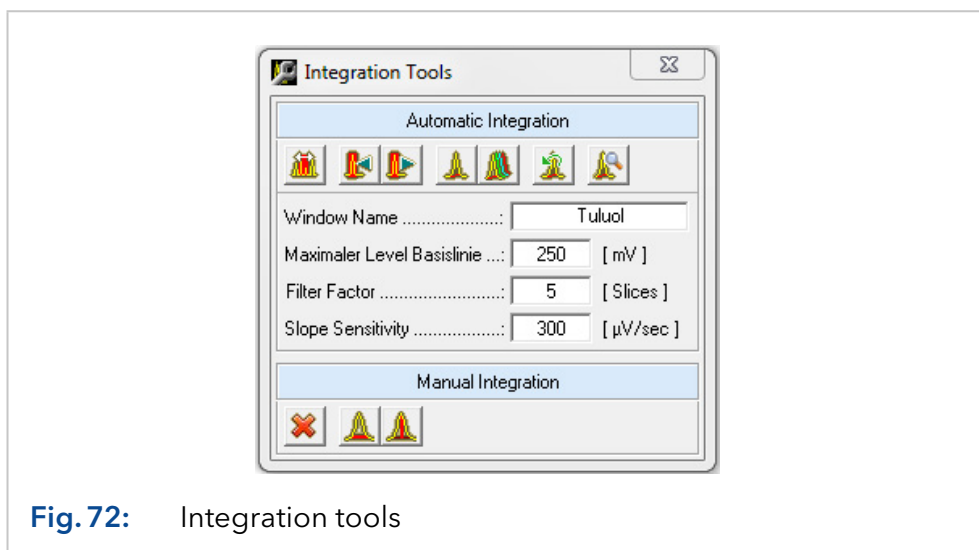







Fig. 72: Integration tools

Button	Explanation
	<i>CREATE / EDIT PEAK WINDOW</i> enables you to create and edit peak windows (see chapter 6.9 on page 46).
	<i>PREVIOUS PEAKWINDOW</i> and <i>NEXT PEAKWINDOW</i> are used to select the peak window. The peak window selected is framed in the graph in the reintegration window. The name of the window is displayed in the box below the toolbar.
	<i>INTEGRATE SELECTED CHANNEL</i> reintegrates the selected chromatogram.
	<i>INTEGRATE ALL CHANNELS</i> reintegrates all the chromatograms of the result file loaded.
	<i>ORIGINAL INTEGRATION</i> reverts to the original integration.
	<i>PEAKSAMPLING PREVIEW</i> displays the result of the online peak sampling. The peaks that will be recognised by the online peak sampling correspond to the filled areas under the chromatogram. Different peak situations are indicated by light vertical lines. When moving the mouse over the recognised peak situations the area between two successive peak situations is highlighted. The corresponding start and end time as well as the respective situation names are displayed in the statusbar.

The reintegration parameters have the following meanings:

MAXIMUM BASELINE LEVEL functions as a threshold for peak sampling. No more peak ends are recognised above the value entered in mV.

FILTER FACTOR: The parameter *FILTER FACTOR* shows the number of slices used to form the first derivative of the gradient calculation.

SLOPE SENSITIVITY: The parameter *SLOPE SENSITIVITY* indicates the size of the gradient where a peak beginning is recognised in µV/sec.

Changing this parameters will affect the integration of your chosen peaks.

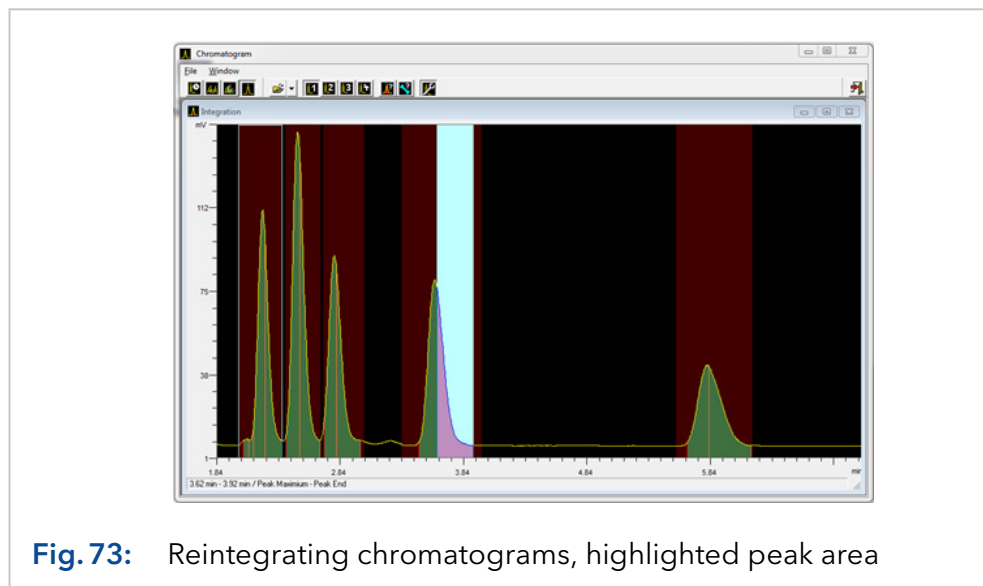





Fig. 73: Reintegrating chromatograms, highlighted peak area

Button	Explanation
	<i>CLEAR INTEGRATION</i> deletes all integration results of the displayed channel.
	<i>SET MANUAL BASELINE</i> allows to insert a baseline manually. Starting point and end point can be fixed by left mouse button. Placed points can still be shifted by left mouse button. After unpressing the button the baseline will be used automatically. For each situation you have to select the button <i>SET MANUAL BASELINE</i> again.
	<i>SET MANUAL DROP</i> allows to insert a drop line manually. The time of the drop can be fixed by left mouse button. The placed drop line can still be shifted by left mouse button. After unpressing the button the drop line will be used automatically. For each situation you have to select the button <i>SET MANUAL DROP</i> again.

14. System visualisation

14.1 General

The function button or the menu option *SYSTEM VISUALISATION*  in the main window opens the system visualisation window.

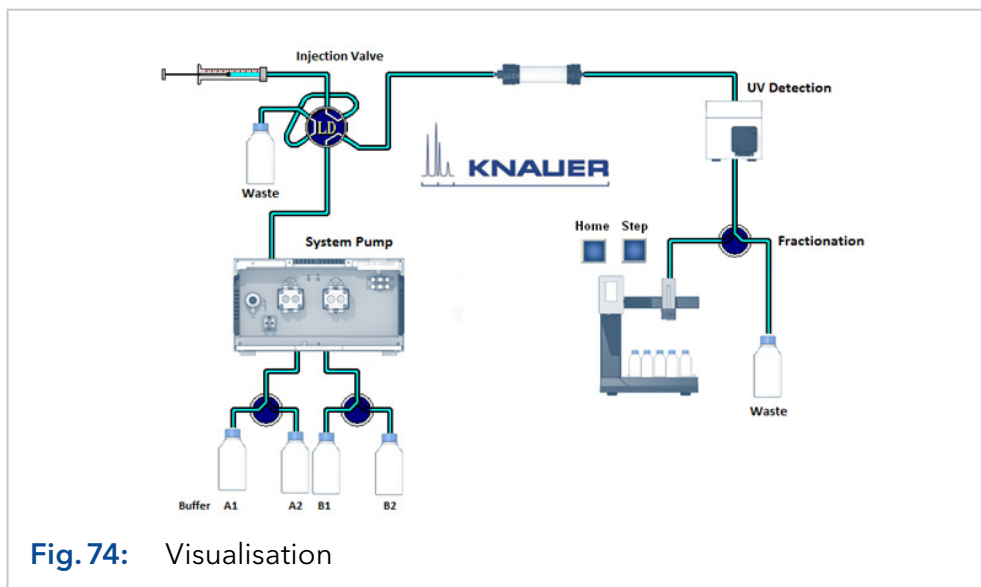

The system visualisation is used to display the flow process graphically, as well as to operate manually all the devices that can be controlled by means of the visualisation. What is more, the display boxes can show data relating to the current pressure, eluent composition, flow rate, detector signals, autosampler vial numbers, fraction collector position and temperature.

A library of graphic objects and the use of background images in Windows Bitmap Format (*.bmp) allow the user to create an individually configured system visualisation.

Each device that can be visualised always displays its current position or state.

The visualisation window can be scaled freely using the menu option Zoom or by dragging the borders of the window.

14.2 System visualisation functions

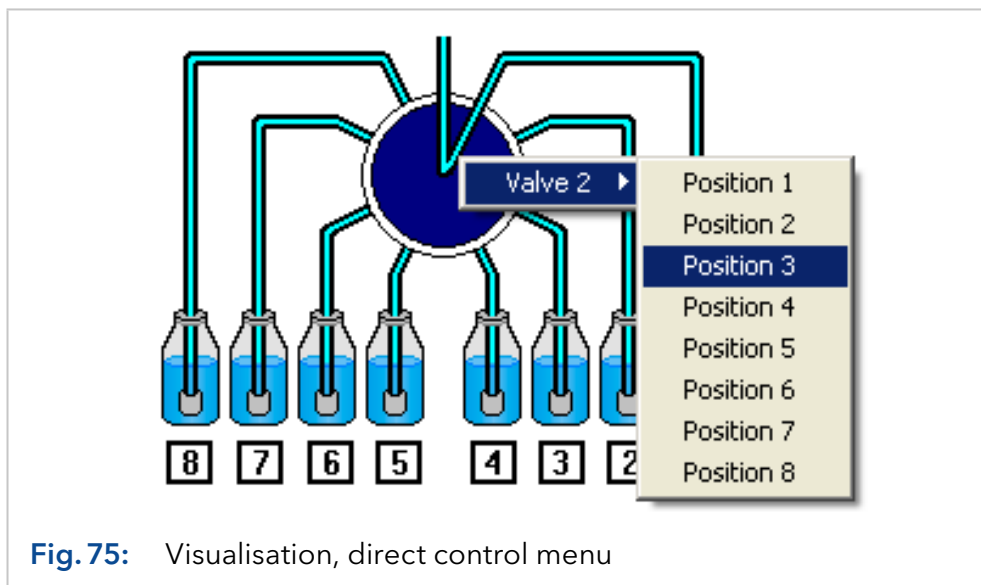

Fig. 75: Visualisation, direct control menu

All the devices that can be visualised can be controlled within the visualisation. To see a menu, right-click the mouse on the device required. The first menu option in the popup menu that appears is the device name, followed by the positions or states to which the device in question can be switched. By left-clicking on the menu options, the device is switched to the corresponding position or state. The *BUTTON* object can be used like a function button by left-clicking with the mouse. Right-clicking on a box (value label) shows the value label's data source.

14.3 Creating a system visualisation

The menu option *SETUP* in the visualisation window opens the system visualisation setup window.

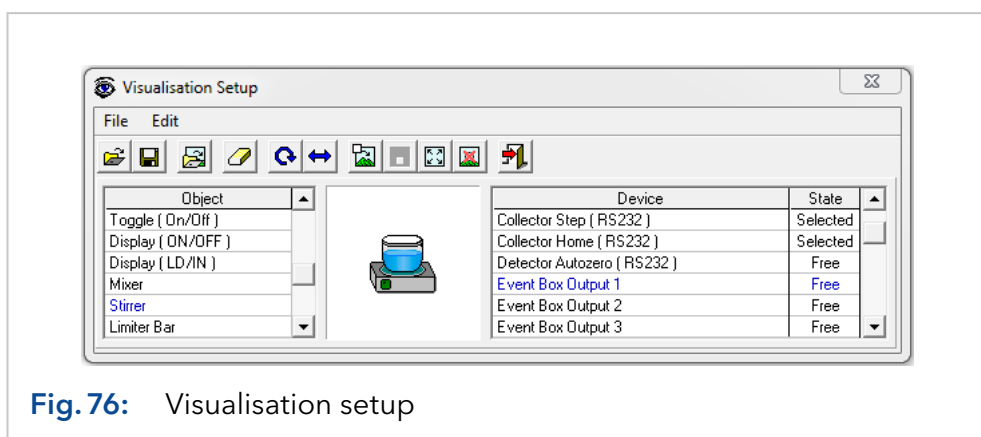













Fig. 76: Visualisation setup

The function buttons in the toolbar have the following functions:

Button	Explanation
	<i>LOAD VISUALISATION</i> opens a previously created visualisation. All the visualisations are to be found in the <i>VISUALISATION FILES</i> folder. This folder can be found in the program directory in the subfolder C:\PurityChrom\Visualisation.
	<i>SAVE VISUALISATION</i> saves a newly created visualisation.
	<i>LOAD BACKGROUND PICTURE</i> opens a background image in Windows Bitmap Format. All the background images are stored in the <i>VISUALISATION BACKGROUNDS</i> folder. This folder can be found in the program directory in the subfolder <i>VISUALISATION</i> .
	<i>CLEAR VISUALISATION</i> deletes the loaded visualisation and all its objects. To avoid accidental deletion, this function is only carried out after confirmation from the user.
	<i>ROTATE OBJECT 90°</i> rotates the selected object 90° clockwise.
	<i>FLIP OBJECT</i> flips the selected object horizontally.
	<i>INSERT OBJECT</i> adds the selected object to the chosen arrangement in the visualisation window. All objects are inserted in their basic position (e.g. valves in position 1).
	<i>PLACE OBJECT</i> places the inserted object at the chosen position in the visualisation.
	<i>MOVE OBJECT</i> moves an already placed object.
	<i>DELETE OBJECT</i> deletes an already placed object.
	<i>EXIT SETUP</i> closes the visualisation setup window.

To create a new visualisation, first draw a background image that corresponds to the devices and tubing in your system. You can use the windows program *PAINT* for this. You will find a number of models for the single elements in the system in the *BITMAP LIBRARY* folder. You must then save the background image in the *VISUALISATION BACKGROUNDS* folder, and load it as a background image using the *LOAD BACKGROUND PICTURE* function.

Now you have to position the appropriate graphic objects for each of the devices to be visualised. The left-hand table in the setup window contains all the graphic objects and the right-hand table contains all the devices in your system that can be visualised. If you choose a value label as an

object, all the values that can be visualised will be the only thing shown in the device table.

The graphic objects are displayed in the preview box in the centre of the setup window. Check here that the object is the same way up as the corresponding element in your background image.

Use the *ROTATE OBJECT 90°* and *FLIP OBJECT* functions to adjust the alignment. Once you have chosen an appropriate device for your system in the right-hand table, you can add the object to the visualisation window with the *INSERT OBJECT* function. It will appear in the top left corner, and can be put in the right place with the mouse or the cursor buttons. When you have done this, use the *PLACE OBJECT* function to add it to the visualisation.

When all the objects have been added, you must save the visualisation using the *SAVE VISUALISATION* function. All the visualisations must be saved in the *VISUALISATION FILES* folder.

15. Displaying the solvent supply

15.1 General

The function button or the menu option *SOLVENT SUPPLY*  in the main window opens the solvent supply display window.

The solvent supply display is used to control the supply of solvents. To prevent a column from running dry, you have the possibility of setting two volume limits in percent. When the volume drops below the first limit, an alarm will sound, and when it drops below the second limit, the pumps will stop.

The values displayed are based on the calculated used volume of solvent at the current flow rate and time passed. This means that there is no provision for pump tolerance in this calculation. For this reason, the volume limits for the warning and turning off the pumps should allow a certain leeway. Regular control of the supply containers also helps to prevent a column from running dry. After refilling of solvents each eluent status should be corrected in the solvent supply window to enable a correct calculation.

15.2 Solvent visualisation

The supply of solvents A to D and the level of the waste container are shown as a graphic on the left-hand side of the window. They are intended to allow the user to make instant checks.

On the right-hand side, the solvent names are displayed, with the current values as volumes and percentages next to them.

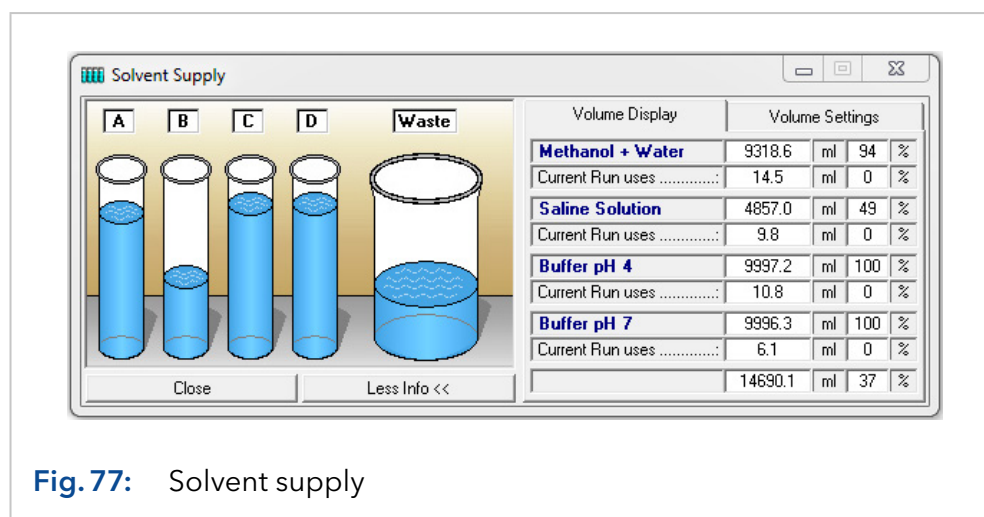

A solvent that has dropped below the minimum percent level set, or a waste volume that has exceeded the maximum percent level, will be marked with a red exclamation mark. You can open the right-hand side of the window with the *MORE INFO* button. You can then use the *LESS INFO* button to close it again. The right-hand side of the window displays the solvent names and the numerical solvent quantities. It also shows the solvent consumption for the current run. The values next to *CURRENT RUN USES* show the solvent consumption of the time control file loaded as a

volume and percentage. This display is intended as a check of whether the solvent supplies are sufficient for the current run.

The values are shown as absolute volumes and as percentages of the total volume.

15.3 Solvent supply display settings

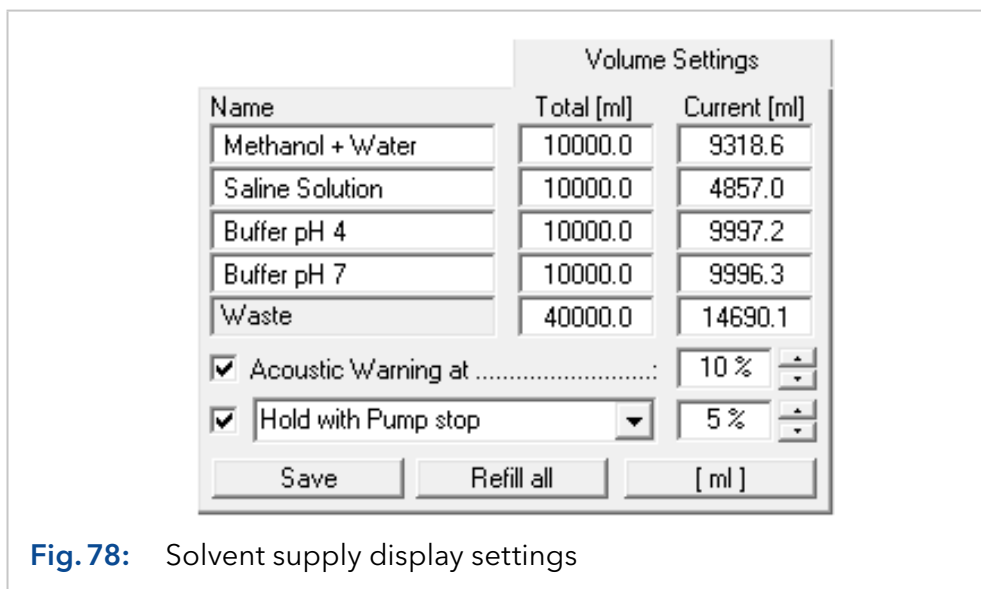

Fig. 78: Solvent supply display settings

In the *VOLUME SETTINGS* part, you can enter your own names for the solvents A to D under *NAME*. Enter the total volume of the individual solvent containers in the boxes under *TOTAL* and enter the current solvent volume in the containers under *CURRENT*. The pumps should be stopped when you enter the current solvent volume, since the values in the boxes are constantly updated when the pumps are running, meaning that your entries will be overwritten.

Use the [I] to switch the unit of volume between [ml] and [l]. The *REFILL ALL* button returns all the current solvent volumes to the total volume of the corresponding containers and the waste container to zero. The *SAVE* button applies and saves the settings.

The option *ACOUSTIC WARNING AT* sets a percentage threshold at which the alarm will sound. You can define the sound in the PurityChrom.ini-file [SolventSupply] (see chapter 23 on page 103). The second threshold with the option *STOP ALL* or *HOLD WITH PUMP STOP* is used to stop the pumps, in order to prevent the column from running dry.

STOP ALL stops the time control file and the pumps, and *HOLD WITH PUMP STOP* pauses the running of the time control file and sets the pumps to a flow rate of 0 ml. When the solvent containers have been refilled, you can resume the time control file using *CONTINUE*. If you don't want to use the Solvent Supply function you will have to deselect the option *ACOUSTIC WARNING AT* and *STOP ALL* or *HOLD WITH PUMP STOP*.

Additionally you have the possibility to use a real level indicator with analog outputs which can be defined in the PurityChrom.ini-file [SolventSupply] (see chapter 23 on page 103).

16. Waste management

16.1 General

The function button and menu option *WASTE MANAGEMENT*  in the main window opens the window where you can visualise the waste management display.

In the PurityChrom.ini-file [WasteManagement] (see appendix) you can define the valve which should function as the waste management valve. The number of the possible containers complies with the number of valve positions. Additionally you have the possibility to bypass the waste management and collect your fractions in the normal waste in defined situations by configuring the bypass valve in the PurityChrom.ini-file [WasteManagement] (see appendix). This valve should have two positions. The first one can switch to the normal waste and the second one can switch to the valve used for waste management.

16.2 Display

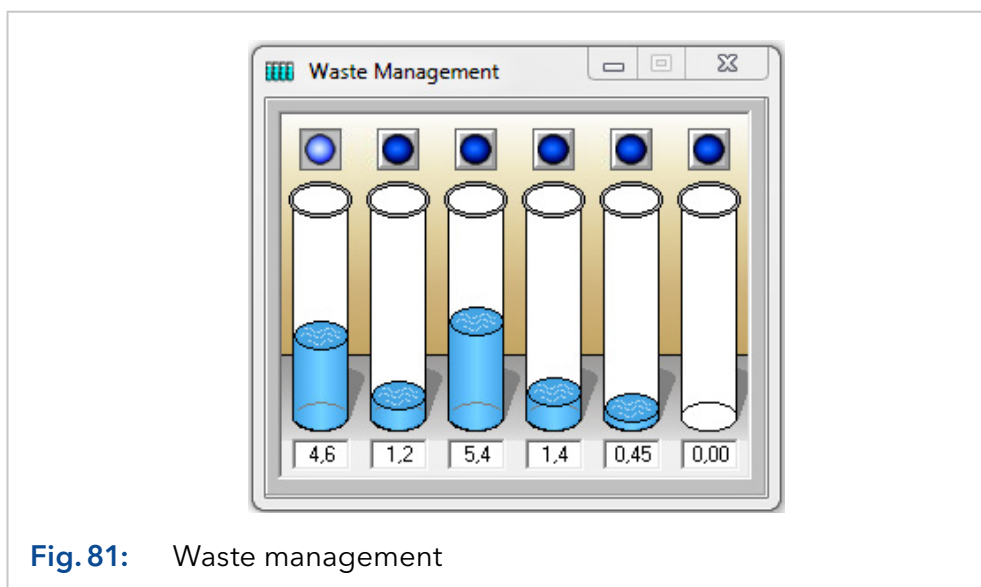

The window will show the number of containers in order of the configured valve positions. The LED above the containers shows if the position on the valve is chosen. At the same time it is also a button for setting the valve position. Below the containers a value display will show the calculated volume inside the container. With a right-button click you can *EMPTY* the container.

16.3 How to use the waste management

A typical usage of the waste management is the automatic sample. In such an application you can collect the non-valuable fractions of each injection separately in case a sample did not bind to the column or the elution went wrong. In a cyclic time control file programming the position will switch to the next position after each run or when the set volume for the container is reached. A new run will only start when the container of the designated position is marked as *EMPTY*. Otherwise the method will switch to *HOLD*. In that case you will get an error message on the screen.

17. Rack display of fraction collector (fraction rack)

17.1 General

The function button or the menu option *FRACTION RACK*  in the main window opens the window with the rack display of the fraction collector.

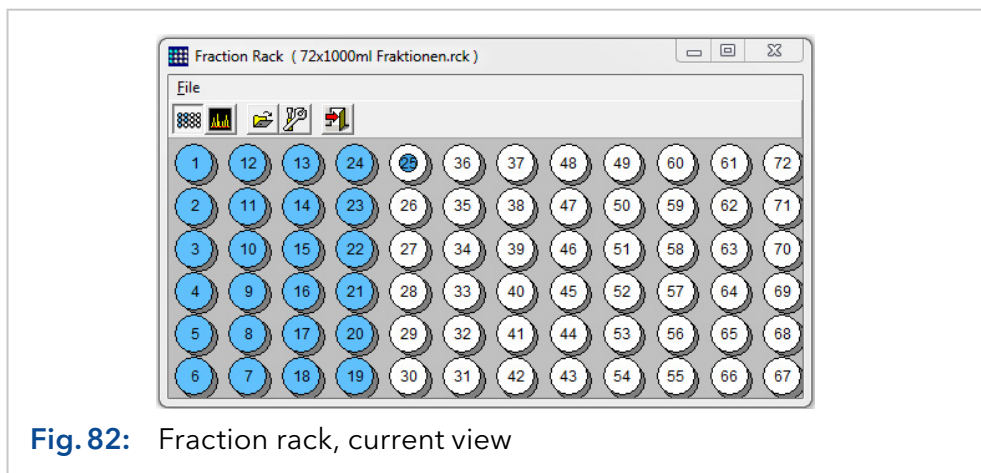

Fig. 82: Fraction rack, current view

The fraction rack can be displayed in two ways:

- The current view shows the fraction collector rack with all the positions.
 - The filled fractions are displayed in blue and the empty ones in white.
 - The current position is indicated by the blue dot.
- The reconstructed view shows the fractions produced by the result file loaded into the reconstruction window.

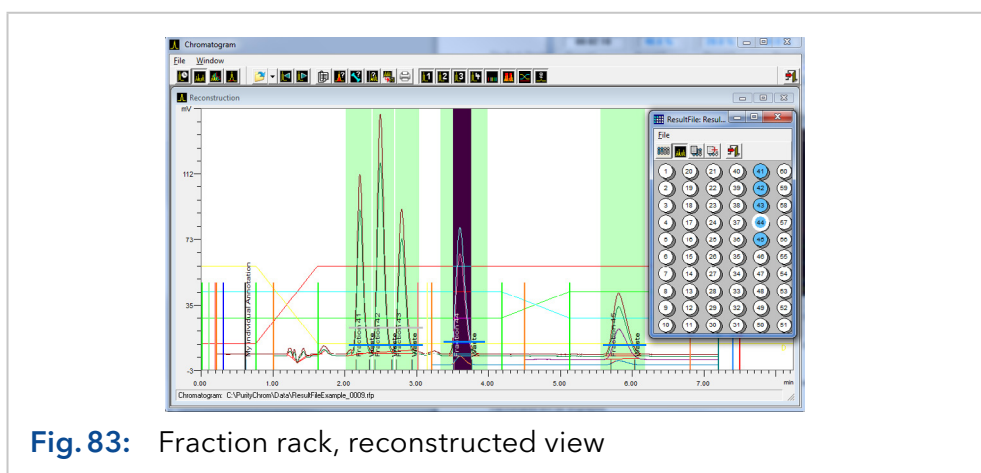









Fig. 83: Fraction rack, reconstructed view

If you left-click on one of the filled fractions, this part of the chromatogram will be displayed inverted. If you left-click on a peak, you will see the position of this fraction in the rack. This will give you a direct graphic relation between the chromatogram and the fraction produced in the fraction collector rack. If you move the mouse over one of the filled fractions, the fraction number and the volume fractionated will be displayed.

17.2 Fraction collector rack functions

Button	Explanation
	<i>SHOW RACK</i> changes to the current view of the fraction collector rack.
	<i>SHOW RECONSTRUCTION</i> changes to the reconstruction view of the fraction collector rack, displaying the result file loaded into the reconstruction window.
	<i>LOAD RACK FILE</i> opens a rack file to display a fraction collector rack. You can also open a rack file out of a result file. The rack file is the same that was used in this run.
	<i>RACK SETUP</i> opens the window to create a rack file to display a fraction collector rack.
	<i>OPEN FRACTION TABLE</i> opens a window where a fraction table can be created.
	<i>ADD FRACTIONS TO FRACTION TABLE</i> adds all fractions of the loaded results file into the fraction table.
	<i>EXIT</i> closes the rack display of the fraction collector.

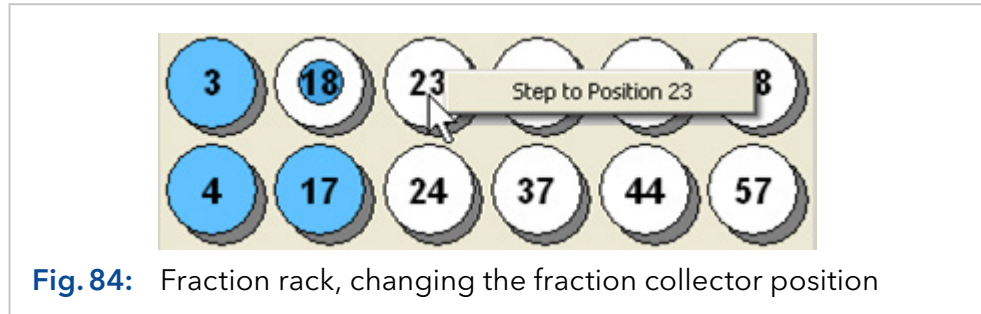

Fig. 84: Fraction rack, changing the fraction collector position

The rack display allows you to change the fraction collector positions directly. To do this, click with the right mouse button on a fraction and then select the menu option *STEP TO POSITION...* with the left mouse button.

17.3 Fraction table

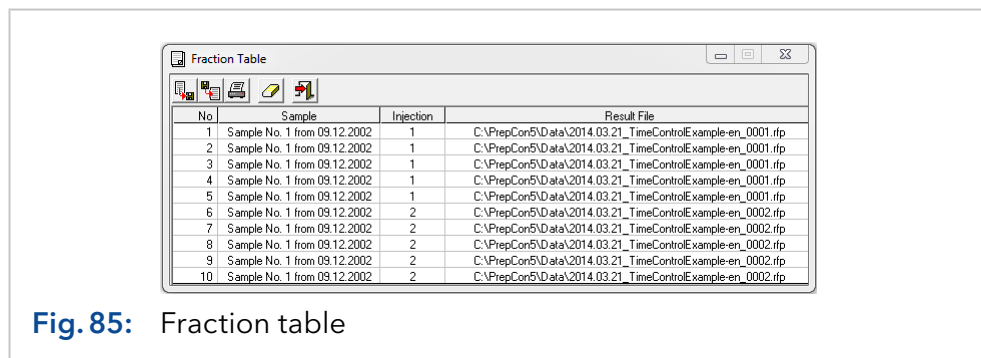







Fig. 85: Fraction table

The fraction table contains a list of fractions, which the user has selected manually in the fractions rack window. Fractions can be inserted into the fraction table by clicking into a fraction of the rack display with the right mouse button and choosing the menu point *ADD TO FRACTION TABLE*. All fractions of a fractionation run can be added into the fraction table by clicking the button *ADD FRACTIONS TO FRACTION TABLE* in the fractions rack window. The table contains the following columns: the fraction number, a sample description, the injection number, the name and the path of the corresponding result file.

The toolbar of the fraction table contains the following function buttons:

Button	Explanation
	<i>IMPORT FRACTION TABLE</i> imports an already existing fraction table.
	<i>EXPORT FRACTION TABLE</i> converts the fraction table into the CSV format (<i>Comma separated Value</i>).
	<i>PRINT FRACTION TABLE</i> opens a dialog window for the print-out of the fraction table.
	<i>CLEAR FRACTION TABLE</i> deletes the content of the fraction table.
	<i>EXIT</i> closes the fraction table.

17.4 Fraction rack setup

The function button *RACK SETUP* opens the window to create or edit a rack file. Rack files contain information about the geometry of the rack and the relation between the number and the corresponding absolute co-ordinates of a fraction.

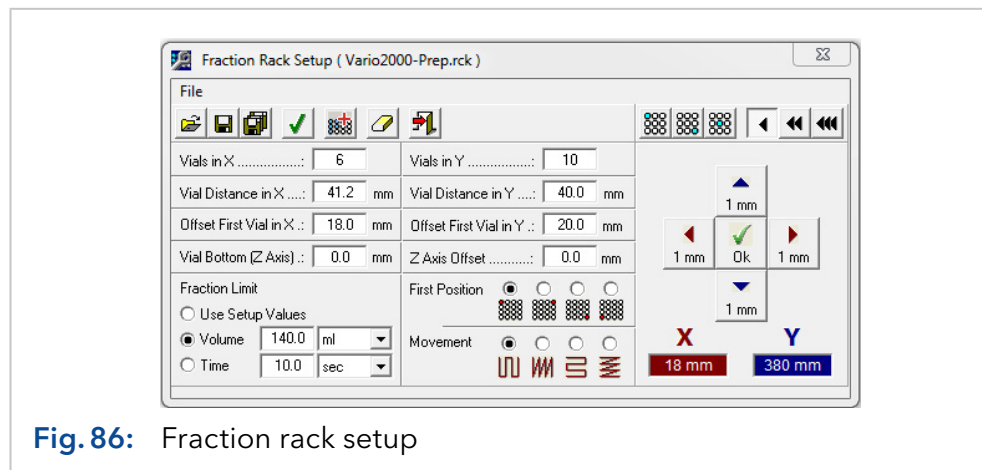

Fig. 86: Fraction rack setup





VIALS IN X and *VIALS IN Y* indicate the number of fractions in the x and y axes. You can enter the distances between the midpoints of the fraction vials in the x and y axes in the boxes *VIAL DISTANCE IN X* and *VIAL DISTANCE IN Y*. You can use *OFFSET FIRST VIAL IN X* and *OFFSET FIRST VIAL IN Y* to define the x and y distance of the midpoint of the first fraction from the home position.



VIAL BOTTOM determines the depth of the fraction vials when a Z Axis is used and *Z AXIS OFFSET* sets the offset of the Z Axis during a fraction step.

FIRST POSITION determines the angle for the first position *MOVEMENT* sets the procedure for fractionating. *ENUMERATION* sets the identification of each fraction.

You can add a maximum fraction volume or fraction time for the fraction limiter in *FRACTION LIMIT*. The values from the limiter setup will be replaced by the rack file values when loading this rack file. If the option *USE SETUP VALUES* is selected, the values in the limiter setup will be retained.









The tool bar left in the window contains the following function buttons:

Button	Explanation
	<i>LOAD RACK FILE</i> to load a previously created rack file.
	<i>SAVE RACK FILE</i> to save a new or changed rack file.
	<i>SAVE RACK FILE AS ...</i> to save a rack file under a new name.
	<i>CREATE SYMMETRICAL RACK</i> creates with the help of given data a symmetrical Rack.
	<i>APPEND RACKFILE</i> appends an already created Rack-file to the current loaded one.

Button	Explanation
	<i>CLEAR RACK FILE</i> to clear the content of the boxes.
	<i>EXIT</i> to close the rack file setup window.

The teaching module of the setup is on the right hand side of the window. This module, allows the positions of the individual fractions to be determined and corrected step by step when using fraction collectors that are controlled by co-ordinates.

The tool bar in the teaching module contains the following function buttons:

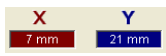
Button	Explanation
	<i>TEACHING TOP LEFT POSITION</i> selects the mode to move to the top left-hand fraction. The co-ordinates are automatically entered in the boxes <i>OFFSET FIRST VIAL IN X</i> and <i>OFFSET FIRST VIAL IN Y</i> .
	<i>TEACHING BOTTOM RIGHT POSITION</i> selects the mode to move to the bottom right-hand fraction. The co-ordinates express the X and Y distances of the fractions one above the other. They are automatically entered in the boxes <i>VIAL DISTANCE IN X</i> and <i>VIAL DISTANCE IN Y</i> .
	<i>TEACHING SINGLE POSITION</i> selects the mode for the corrector of the fraction that is indicated in the rack display as the current fraction.
	<i>TEACHWIDTH 1 MM</i> sets the step distance when moving to a fraction at 1 mm.
	<i>TEACHWIDTH 10 MM</i> sets the step distance when moving to a fraction at 10 mm.
	<i>TEACHWIDTH 50 MM</i> sets the step distance when moving to a fraction at 50 mm.
	A click on one of the <i>TEACHING BUTTONS</i> moves the arm of the fraction collector by the distance set in the corresponding direction.
	When it has reached the position required, the co-ordinates can be recorded by clicking on the <i>Set</i> button.
	The current position of the fraction collector is shown in the X and Y co-ordinate displays.



Note: Some functions of this rack setup are not compatible with Foxy fraction collectors

18. RID 2.1L setup



Note: To control the RID 2.1L a driver must be changed. Copy the driver RID21L.dll from C:\PurityChrom\DriverDll to C:\Windows\SysWOW64 (64-bit system) or C:\Windows\System32 (32-bit system). Rename the driver to „PrepconLF.dll“.



Note: It is not possible to control CM 2.1S and RID 2.1L together.

In the menu option *FILE* in the main window of PurityChrom you will find the RID 2.1L Setup:

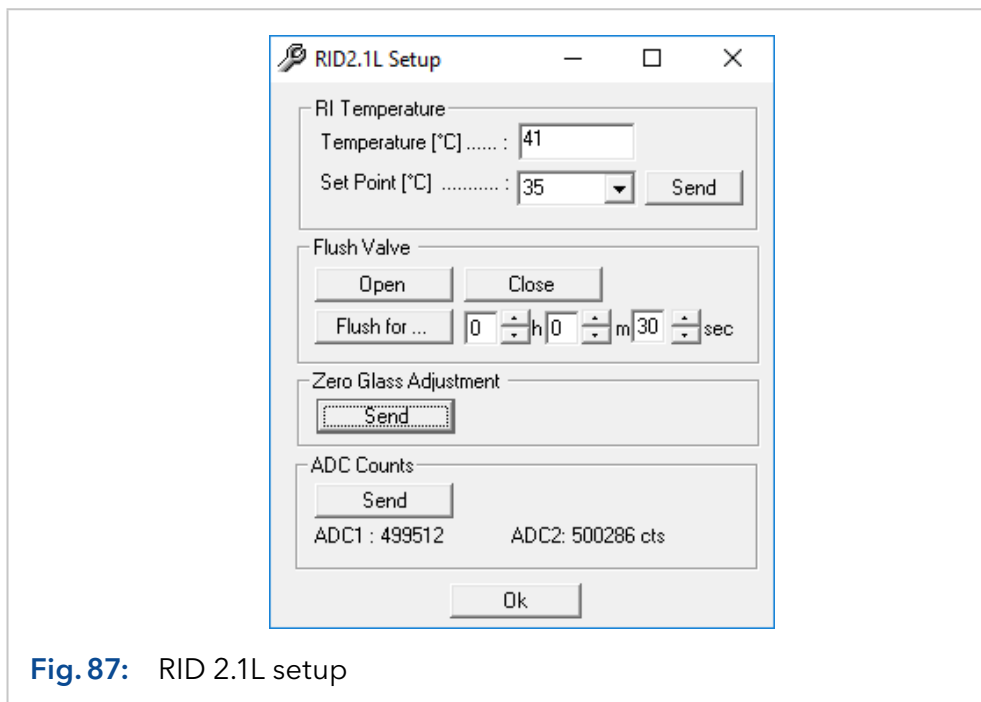

Fig. 87: RID 2.1L setup

For temperature control of the AZURA® Detector RID 2.1L, the temperature must be activated in the PurityChrom.ini. Therefore, set TempZone=1 in the [KNAUERRID21L] section. For the use of the default temperature of the RID 2.1L set the temperature to the default value (Temperature=35 for analytic device; Temperature=0 for HighFlow version). The temperature can be acquired during the analysis. Therefore, set the channels of the RID 2.1L in the .ini-file to: Channels=2.

In the [Temperature] section a name for Tempzone can be given:
[Temperature] FunctionName1=RID

To set a temperature select a *SET POINT* and push the send button. The actual temperature is shown at *TEMPERATURE*.

Temperature [°C]: Current Temperature

Set Point [°C]: Temperature of choice

To flush the reference and measurement cell, the flush valve must be opened (*OPEN*: Opens the Flush Valve, *CLOSE*: Closes the Flush Valve).

For a time-limited flush, you can select a time. A countdown will appear in the upper right corner.

ZERO GLASS ADJUSTMENTS: The position of the zero glass will be adjusted if the device is switched on. If unjustified, you can let adjust the device the zero glass by clicking the *SEND* button.

ADC COUNTS: The light intensity for both channels must be nearly identical. For a new device, every channels should have about 500 000 counts. After clicking the *SEND* button, the device tries to set the balance.

19. Control of mass spectrometers

19.1 General

Mass spectrometers can be implemented in PurityChrom either via MS-LC coupling or via direct control with the PurityChrom software. So far the mass spectrometer 4000 MiD is implemented.

The control of the 4000 MiD follows the logic of the control within the Masscape® software by Microsaic. Complex and not often used functions like calibration of the spectrometers are not available in PurityChrom 5. In order to perform these tasks there is a possibility to switch from PurityChrom to the Masscape® software using TightVNC for the remote connection.

19.2 Control of the 4000 MiD / MIDAS Spectrometer

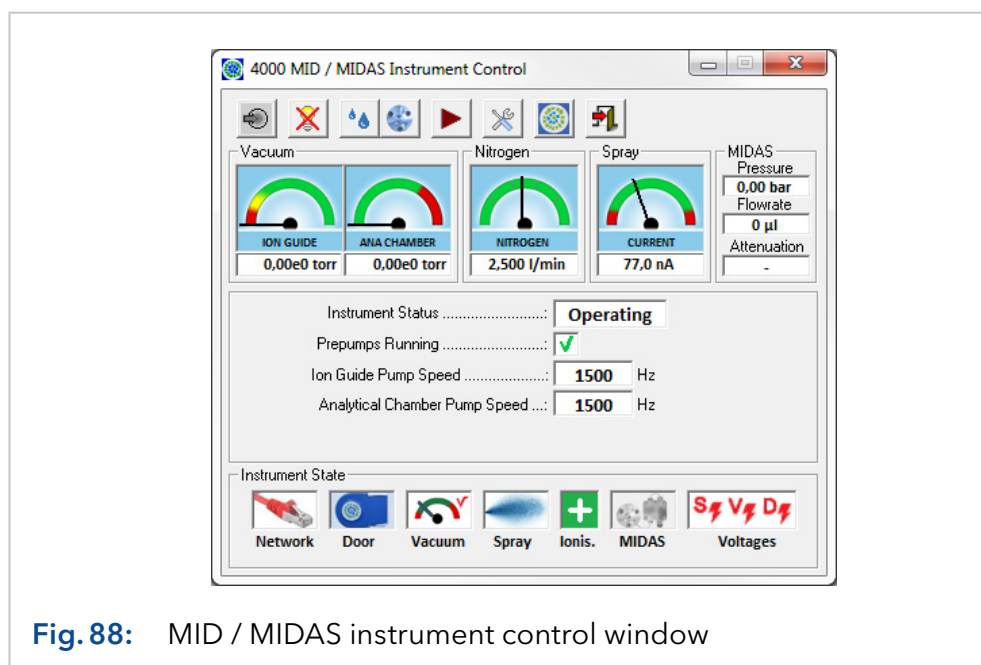

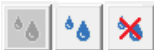





Fig. 88: MID / MIDAS instrument control window

19.2.1 Function buttons

Button	Explanation
	<p><i>PUMP DOWN, VENT, VENT DISABLED:</i> If the mass spectrometer is vented pressing Pump down starts the vacuum pumps. If the spectrometer is evacuated but not in operation the system can be vented.</p> <p>If the measurement is started using ,Operate' the spectrometer can not be vented and this function button is disabled.</p>

Button	Explanation
	<p><i>START MEASUREMENT (OPERATE), STOP MEASUREMENT:</i> The operate function button is available as soon as the vacuum has sufficient quality. During operation the measurement can be stopped using this function button. In case makeup pump and/or attenuator are active, they will be switched off as well.</p>
	<p><i>START AND STOP MAKEUP PUMP:</i> This function is only available while the MIDAS is switched on and activated with the Masscape Software and the measurement is in operation.</p>
	<p><i>START AND STOP ATTENUATOR:</i> This function is only available while the MIDAS is switched on and activated with the Masscape Software and the measurement is in operation.</p>
	<p><i>START AND STOP SCAN:</i> This function is available once the measurement is in operation. Starting a time control file will start scan automatically. Scan can not be stopped during execution of a time control file.</p>
	<p><i>SETUP:</i> Opens setup window. This function is only available while scan is not started. See below for details.</p>
	<p><i>MASSCAPE:</i> Stops control of the 4000 MiD Spectrometer by PurityChrom and allows for a remote desktop connection via TightVNC to the internal linux PC of the MiD running the Masscape® software. This function is not available while the measurement is in operation.</p>

19.2.2 Displays







Display for vacuum, N usage, spray current as well as makeup pump pressure and flowrate and the attenuation are available while scan is not started.

In addition displays are available for:

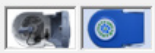
- Spectrometer status
- Prepump status (on/off)
- Speed of the ion chamber turbo pump
- Speed of the separation chamber turbo pump
- Warning messages

While scan is active the numerical measurement values (e.g. number of detected ions, gate time) for the selected mass acquisition channels (defined in the setup, see below) as well as the total ion current (TIC) will be displayed.

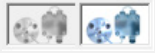
Status displays

Button	Explanation
	<i>NETWORK</i> indicates whether a connection to the mass spectrometer could be established.
	<i>DOOR</i> shows the status of the cover of the spray source - open or closed. If the door is opened the spray voltage is switched off and the measurement can not be started.
	<i>VACUUM</i> indicates if pressures are sufficient for measurement.
	<i>SPRAY</i> : Status of the spray source.
	<i>IONISATION</i> shows which ionisation is selected in the setup.
	<i>MIDAS</i> indicates whether makeup pump und attenuator are running.
	<i>VOLTAGES</i> indicates whether spray voltage, voltage of ion optics and high voltage of the detector are designed values. During operation all three voltages must be switched on.

19.2.3 4000 MiD / MIDAS setup

The parameteres entered in the setup window may be partly overwritten by parameteres in the time control file.

Midas setup

On the tab MIDAS Setup the flowrate of the makeup pump and the attenuation can be entered.

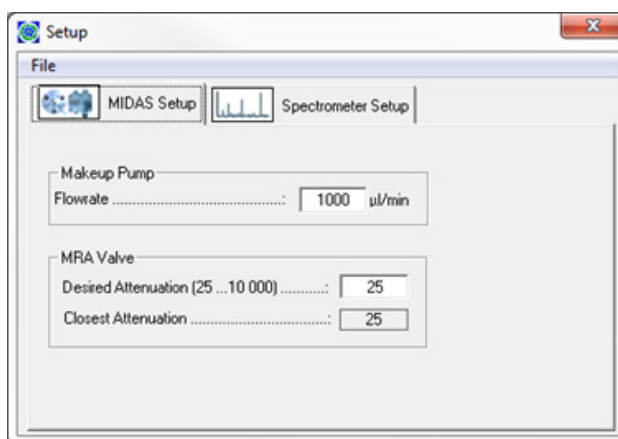

Fig. 89: MIDAS setup window

Spectrometer setup

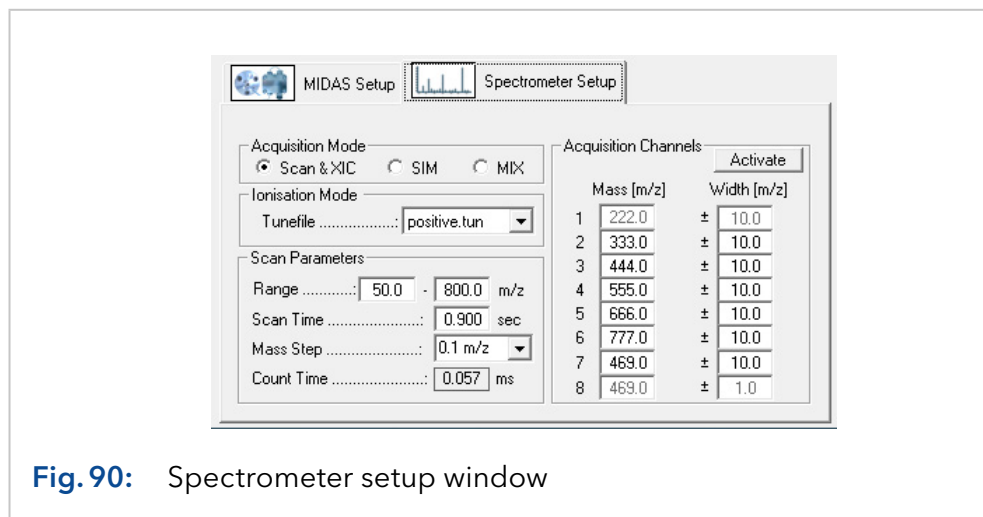

Fig. 90: Spectrometer setup window

Measure method There are three ways of acquiring data: Scan & XIC, MIX or SIM. The default acquisition mode is Scan & XIC. In the Scan & XIC mode PurityChrom acquires complete mass spectra and single mass data tracks are extracted as chromatograms. PurityChrom can save the complete spectrum into the resultfile. In the SIM acquisition mode only selection ion masses are measured, no spectra can be saved. The MIX mode can be activated in the .ini file (see Appendix) and records selected ion masses like the SIM mode but also records the whole spectrum.

Ionisation mode Depending on the chemical properties of the samples the positive or negative ionisation mode can be used. The ion mode is selected via parameter files (tune files) e.g. positive.tun and negative.tun. The tune files can only be adjusted using the Microsaic Massscape software.

Mass range: Ranges between 50 and 800 m/z can be selected. Masses below 50 can not be measure.

Scan time: Overall scan time for a full spectrum

Mass step: Can be set to 0.1 or 0.2 m/z

Count time: Count time for one single point. The count time is calculated using mass range, scan time and mass step.

Acquisition channels: Up to eight masses can be define for the chromatogram channels. These parameters will be overwritten by the entries for MS channels (see below) in the time control file when loading the file.

Mass spectrometer parameters in the time control file

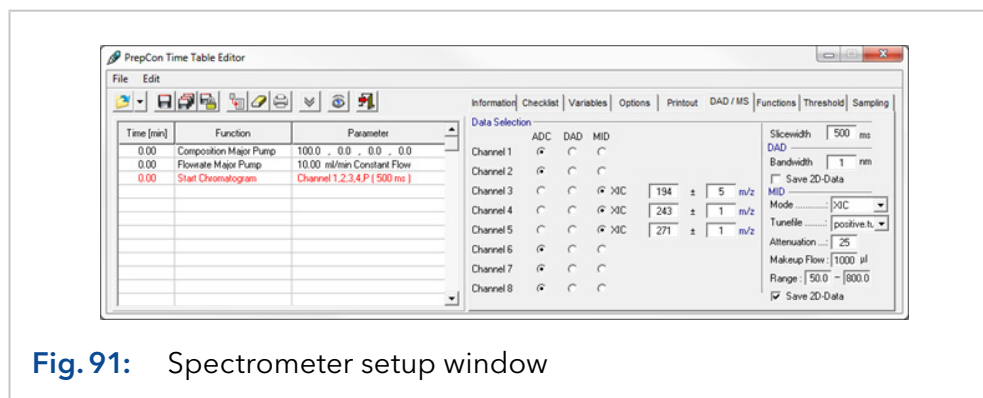

Fig. 91: Spectrometer setup window

The following parameters for the control of the mass spectrometer are available on the DAD/MS tab of the time control file editor:

Data selection: For up to 8 channels you can choose whether a AD-Converter is used as data source (also choose this option for the channels of a UV detector), which wavelength range is used for channels of diode array detector or which mass tracks are acquired from the mass spectrometer.

Slicewidth: The data point density, slicewidth in milliseconds. Same value for the slice width in the DAD/MS tab and in the start chromatogram command have to be applied.

Mode: The acquisition mode of the mass spectrometer: XIC or SIM and MIX (see MS setup, above)

Attenuation: Setup for the MIDAS-Attenuator

Makeup Flow: Flow rate of the MIDAS makeup pump.

Range: Mass range for the scan (see MS setup, above)

Save 2D-Data: If this option is selected, all mass spectra acquired during the data acquisition will be saved to the result file. Saved spectra can be viewed in the reconstruction window.

20. Control of heating devices

20.1 CT 2.1



Note: To control the CT 2.1 a driver must be changed.

- Copy the the driver CT21A.dll from C:\PurityChrom\DriverDll to C:\Windows\SysWOW64 (64-bit system) or C:\Windows\System32 (32-bit system).
- Rename the driver to "thermocontrol.dll"
- In the [Temperature] section a name can be given: [Temperature] FunctionName1= CT 2.1
- Add IP-address of column oven under [Winsock-Port] in the PurityChrom.ini file.
- In the setup menu of PurityChrom, choose "heater control", the winsock port and as driver "MultComDll" in the communication tab.

20.2 Memmert UN 55 Oven



Note: To control the Memmert UN 55 Oven please activate the corresponding entry in the .ini file (see Appendix). The IP Adress has to be set directly on the oven and remote access has to be allowed in the oven setup.

- In the [Temperature] section a name can be given: [Temperature] FunctionName1=UN 55
- The Oven can be controlled via the Temperature Settings button.

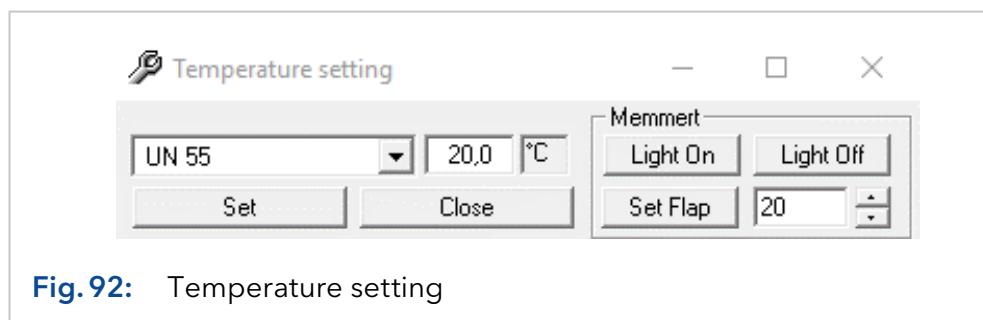

Fig. 92: Temperature setting

21. Event box

21.1 Manual control of the event box

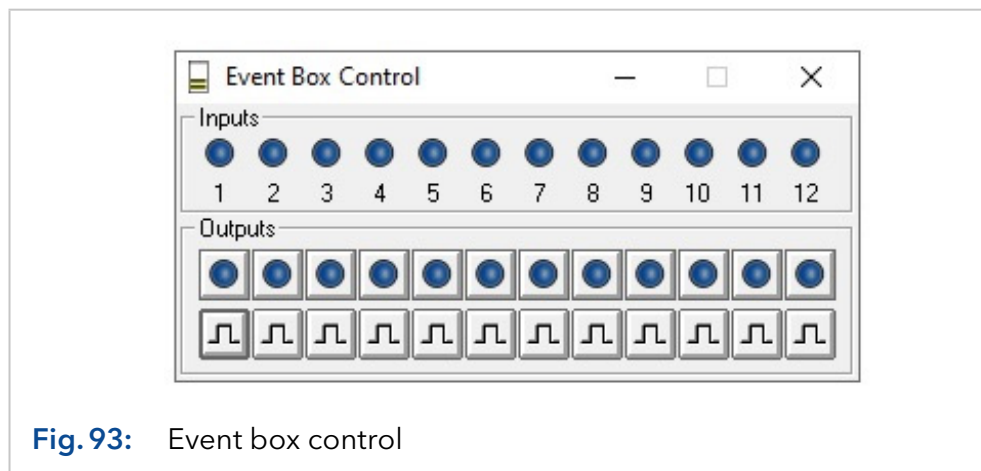



Fig. 93: Event box control

The function button or the menu option *EVENT BOX*  in the main window opens the event box window. The upper row of LEDs represent the inputs. An active input is shown by a lit up LED. The buttons in the lower part of the window are used to switch the outputs manually. The upper row of buttons switch the outputs on or off statically. The LEDs in the buttons show the status of each output. The lower row of buttons switch the outputs with a pulse lasting one second.

For standard KNAUER Systems the Inputs and Outputs of the eventbox will either receive or give out a signal to the pin header of the system pumps (P 6.1L or P 2.1L). Please see the table for corresponding In- and Outputs and corresponding functions on the pin header.

21.1.1 Eventbox Input

	Device	Function
Input 1	Major pump	Start In
Input 2	Major pump	Error In
Input 3	Major pump	Leaksensor
Input 4	Major pump	Activation upon motorfailure
Input 5	Minor pump	Start In
Input 6	Minor pump	Error In
Input 7	Minor pump	Leaksensor

	Device	Function
Input 8	Minor pump	Activation upon motorfailure

21.1.2 Eventbox Output

	Device	Function
Output 1	Major pump	1TTL
Output 2	Major pump	1TTL
Output 3	Major pump	3OC
Output 4	Major pump	4TTL
Output 5	Minor pump	1TTL
Output 6	Minor pump	1TTL
Output 7	Minor pump	3OC
Output 8	Minor pump	4TTL

22. Troubleshooting

22.1 Error message lamp lifetime

After the start of PurityChrom with a set MaxD2Time=XXXX (1-2000) in the .ini-file a pop up window occurs if the set value for the lamp life time is exceeded.

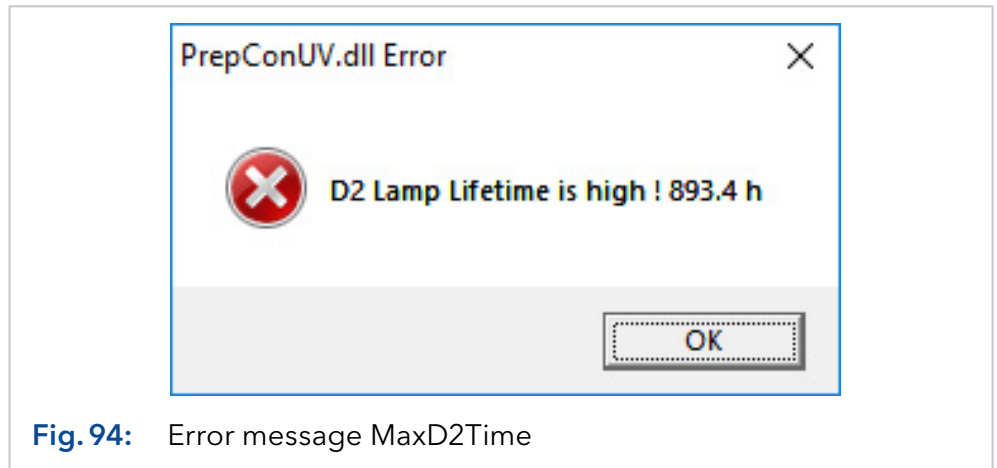

Fig. 94: Error message MaxD2Time

The error can be quit with ok. Normal work with the system is possible afterwards.



Note: If the message is not confirmed immediately, the detector will not respond and no UV-signal is shown in the main window. Restart the software and confirm the message immediately or set MaxD2Time = 0 in the .ini-file.

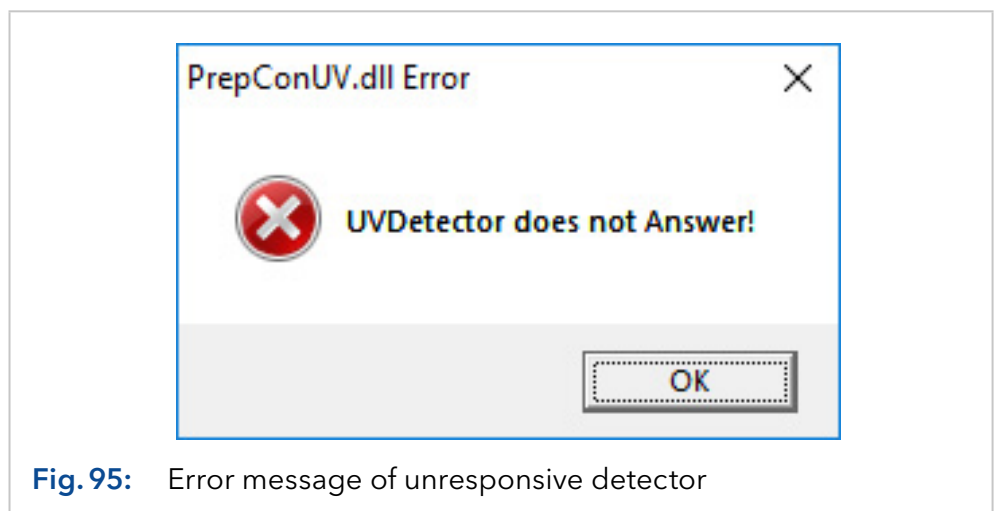

Fig. 95: Error message of unresponsive detector

22.2 Communication Error: Interface sends an error

If a window with „Interface sends an error“ appears, please press the button „show error“ to get a detailed failure message.

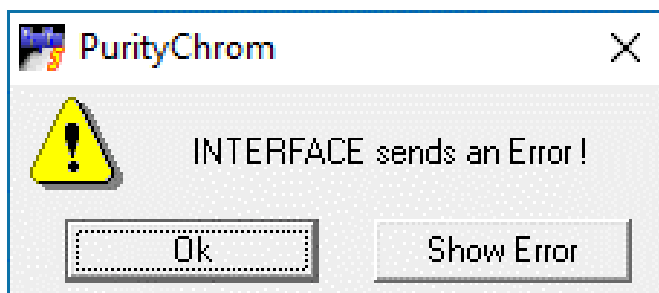

Fig. 96: General failure message, Interface sends an Error

The detailed failure message includes the sign # followed by a number. This number is related to the ranking order of the devices in the setup menu. Accordingly, “#1” stands for the major pump, “#2” for the minor pump and “#6” for the heater control and so on.

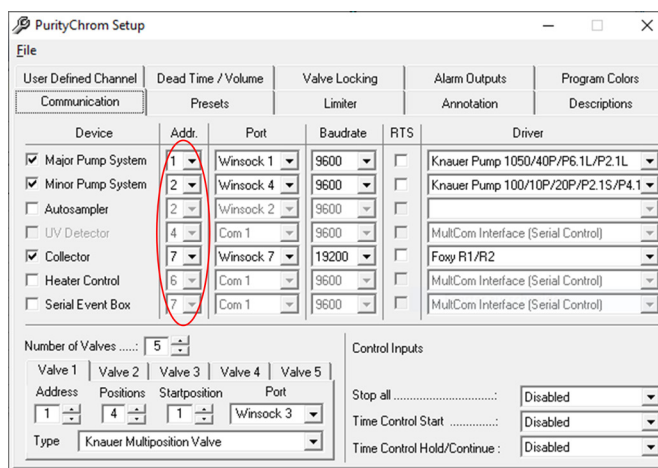
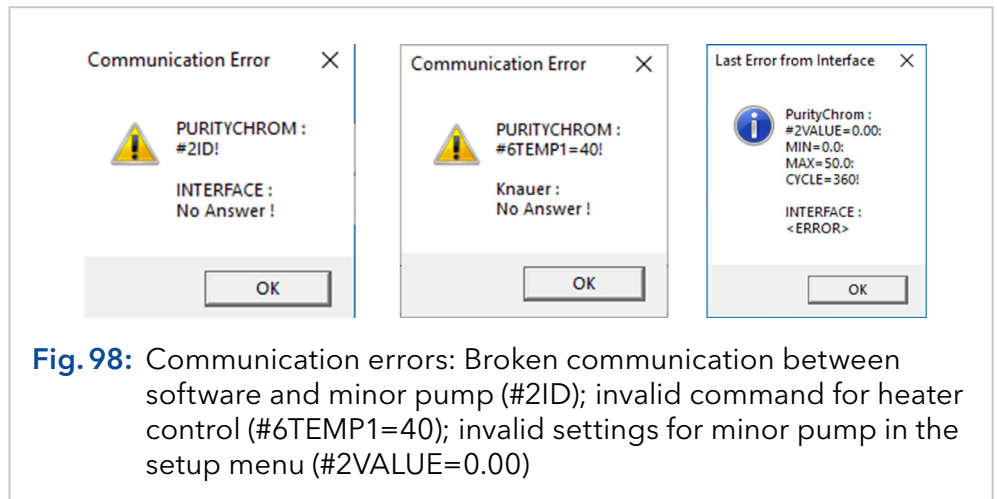

Fig. 97: Setup Menu with ID-numbers of devices used in failure messages

“No Answer” within a failure messages indicates that the communication can not be achieved. The reason for that might be an invalid command, a problem with LAN connection or the necessity of a restart of the software or/and the device. If the ID number is followed by values, these indicate incorrect settings in the setup menu, e.g. #2VALUE could indicate an invalid maximum pressure of the minor pump.



23. Appendix

23.1 The entries in the file PurityChrom.ini

You can find the PurityChrom.ini file in C:\Windows.

	Entries		Explanation
[MainWindow]	AlwaysOn-Top=0	[0/1]	The main window is always in the foreground.
	SolventConfirm=0	[0/1]	Starting the pump with the eluent buttons must always be confirmed by the user.
	DataPathSelection=0	[0/1]	After loading a time control file the user can select a folder for the result files.
	MultiLingual=1	[0/1]	The program is corresponding to the operating-system multilingual (0 = English, 1 = German).
	DateFormat=YYYY.MM.DD	[0/1]	The programs date format
	WavelengthRequest=0	[0/1]	Before starting a time control file, the user will be asked for a uv wavelegth.
	MCMonitorMode=1	[0/1]	If Mobile Control is running at the start of PurityChrom, it's access to the devices will be restricted. If PurityChrom stops it will gain access back.
[Boards]	Order=PCI-FIRST	[PCIFIRST /ISAFIRST]	Order of the analog channels if ISA and PCI cards are used combined.

	Entries		Explanation
[WinsockPorts]	Port1=	[IP/PORT]	<ul style="list-style-type: none"> ■ IP-Address and portnumber of the used Winsock-Ports. The portnumber will be appended with a comma after the IP-address. ■ Winsock-Ports which are not used should not have parameters. ■ Freestanding devices have the portnumber 10001. ■ Assistants represent maximum three devices with three individual Winsock Ports, with the same IP address, differing only in the IP port for the correct IP port please refer to the Firmware Wizard or the ASM 2.1L/ASM 2.2L user instructions. ■ The Foxy R1 or R2 has the portnumber 23. ■ AS3950 / AS 6.1L has the portnumber 2101.
	Port2=		
	Port3=		
	Port4=		
	Port5=		
	Port6=		
	Port7=		
	Port8=		
[AutomaticDataFiles]	CSVFile=0	[0/1]	A chromatogram file in *.csv format will be saved automatically at the end of a run.
	FractionTable=0	[0/1]	A fraction table in ASCII format will be saved automatically at the end of a run.
	SaveResult-WithSequence=1	[0/1]	While executing a sequence table save resultfiles (.rfp) in the same folder (1) as the sequence files (.seq) or (0) as the time control file (.tcf)
[User Company]	Name=KNAUER	[Text]	User defined company name for all prints.
	FontName=Arial	[Text]	Name of the font for the company name.
	FontSize=18	[Value]	Fontsize for the company name.
	FontBold=0	[0/1]	Bold font for the company name.
	FontItalic=0	[0/1]	Italic font for the company name.
	FontColor=128	[Value]	Font color for the company name.

	Entries	Explanation
[Pumps]	ConstantModeMajor=0 ConstantModeMinor=0	[0/1] The pump system supports a constant pressure mode, i.e. a flow rate control for working at a constant pressure.
	Note: Constant pressure mode is not supported by KNAUER pumps	
	PumpStopRequest=1	[0/1] 0= „stop all“ in a time table stops the pumps. „stop all“ button in main window stops the pumps immediately. 1= “stop all“ in a time table does not stop the pumps. „stop all“ button in main window stops the pumps only after additional confirmation.
	OnlineMoving=1	[0/1] The pump system supports the online gradient shift.
	Autozero=0	[0/1] The pump interface supports a potential free switch for a UV auto-zero function.
	MaxPressFactor=1	[0/1] The maximum pressure value will be scaled appropriate to the pressure range.
	PressureChannel=0	[0/1-8] The pump pressure signal will be acquired by the specified A/D-conversion channel.
	ParameterChange=0	[0/1] The buttons 100% Solvent A-D and flowrate are enabled during a time control run.
	FlowDimension=ml	[µl/ml/l] Dimension of the pump flowrate.
	IOControl=0	[0/1] Pump interface supports an emulation of an eventbox
	SoftwareHPG=0	[1/2/3] The high pressure gradient pump system is used isocratically or as binary or ternary gradient. [0] An LPG is used.
	SoftwareHPGPort2=	[IP/Port] A free-standing pump is used for a binary gradient.
	MixingChamber	[µl] The volume of the connected mixing chamber

	Entries	Explanation
	PreciseMixing [0/1]	Only important for low pressure gradient P6.1L. Do not change from 0 to 1.
	LimiterVolumeMinor=0 [0/1]	0=Limiter volume from major pump 1=Limiter volume from minor pump
	MinorPumpPressure=0 [0/1]	0=Pressure of major pump is shown in toolbar 1=Pressure of minor pump is shown in toolbar
	LPGType=0 [0/2/3] Note: Only for P 2.1L!	0=set the P 2.1L to isocratic 2=set the P 2.1L to LPG binary 3=set the P 2.1L to LPG ternary
[Autosampler]	TempPrecision=3 [°C]	Precision of set temperature.
	MaximumSamples=100 [Value]	Maximum sample capacity of the autosampler.
	VolumeDimension= μ l [μ l]	Dimension of the injection volume. Do not change this entry.
	AS3000=0 [0/1]	The autosampler is a Labomatic AS3000.
	VarioPrep=0 [0/1]	The autosampler is a SCPA VarioPrep.
	Alias=0 [0/1]	The autosampler is a Spark Alias.
	KNAUER 3950=0 [0/1]	The autosampler is a KNAUER 3950 or AS 6.1L.
	Wash=0 [0/1]	1= washing cycle begins when starting the software. 0= washing cycle after starting the software is turned off.
	TubingVolume=15 [μ l]	Standard tubing volume (volume between needle and valve).
	FlushVolume=30 [μ l]	Standard flush volume (2x tubing volume).

	Entries	Explanation
	PrepMode=0 [0/1]	Turn the PrepMode on when controlling prepa-rative autosampler AS 6.1L with 10 ml loop and 2.5 ml syringe volume.
	TransportLiquid=1 [0/1]	0=Washing solution from wash bottle. 1=Washing solution from transport bottle, or vial 85 if 84+3 was chosen.
	TransportVolume=1 [1-9]	Number of syringe loads for washing
[SequenceTable]	MinSamplePosition=0 [0 - ...]	Input limit in sequence table
	MaxSamplePosition=100 [0 - ...]	Input limit in sequence table
	MinInjections=0 [0 - ...]	Input limit in sequence table
	MaxInjections=1 [0 - ...]	Input limit in sequence table
	MinVolume=0 [0 - ...]	Input limit in sequence table
	MaxVolume=10000 [0 - ...]	Input limit in sequence table
	DefaultVolume=100 [0 - ...]	Preset in sequence table
	OLBImport=0 [0 or 1]	Import sequence from MassLynx- olb file possible
	EnableInit=0 [0 or 1]	Activates dialog window on start of a se-quence allowing for initialisation
	AdditionalFields=0 [0 or 1]	Additional text fields in the sequen- ce table and the report printout
[Collector]	Cetac=0 [0/1]	Activates the direct control of Cetac fraction collector
	StepAtWaste=0 [0/1]	Automatic fraction collector step when swit-ching to waste.

	Entries	Explanation
	HomeOutput=0 [1-12]	Event box output for a home fraction collector.
	CollectorArray=0 [0/1]	Serial switching of several fraction collectors.
	Collectors=0 [2- ...]	Number of fraction collectors in the series.
	CollectorValve=0 [1- ...]	Number of the waste/fraction valve when several collectors are switched in series.
	Autozero=0 [0/1]	The collector supports a potential free switch for a UV autozero function.
[FractionCleaning]	Enabled=0 [0/1]	Automatic fraction cleaning enabled/disabled.
	WashTime=2 [Value]	Wash time in the washing station.
	XOffset=71 [Value]	X-offset to reach the fraction coordinate.
	YOffset=-20 [Value]	Y-offset to reach the fraction coordinate.
	ZOffset=0 [Value]	Z-offset to reach the fraction coordinate.
[Aliquotation]	Enabled=0 [0/1]	Automatic aliquotation enabled / disabled.
[Detector]	AutozeroAnnotation=1 [0/1]	On each autozero an annotation will be written into the chromatogram.
	CheckLampStatus=0 [0/1]	0=Lamp status will not be checked 1=Lamp status will be monitored
	CheckforLeak=1 [0/1]	Leak sensor can be activated here
	Leakage-Message= ... [Text]	Please do not change
[ShimadzuRF20A]	Enabled=1 [0/1]	UV is disabled/enabled
	Port= [Port]	Port number
	Channels=1 [Value]	Number of channels

	Entries	Explanation
	Gain=1 [Value]	1=x1, 2=x4, 3=x16
	Sensitivity=0 [Value]	0= High, 1=Medium, 2=Low
	DataRate=2 [Value]	Datarate of the detector
	AnswerTimeOut=1 [Value]	Do not change
	ConnectionTimeOut=1 [Value]	Do not change
[KnauerUVD]	Enabled=1 [0/1]	UV is disabled/enabled
	IP= [IP]	IP-address
	Port= [Port]	Portnumber
	BaudRate=9600 [Value]	Baudrate
	Wavelength1=254 [Value]	Preset wavelength
	DataRate=2 [Value]	Datarate of the detector
	Channels=1 [Value]	Number of channels
	Integration=100 [Value]	Integration time
	OptimiseIT=1 [0/1]	Enable/disable integration time optimisation
	Type=UVD2.1S [Type]	Your detector type (UVD 2.1S, UVD 2.1L or MWD 2.1L)
	MaxD2Time= [0-2000]	Maximum life time of UV lamp: life time of the lamp will be checked, when software starts 0=off, 1-2000=Hours When the maximum value is exceeded, an error message occurs. However, work may be continued after confirming the message (see chapter 22 on page 100).

	Entries		Explanation
[KnauerRID21L]	Enabled=	[0/1]	RID is disabled/enabled
	IP=	[IP]	IP-address
	Port=	[Port]	Portnumber
	DataRate=2	[Value]	Datarate of CM 2.1S
	Channels=1/2	[Value]	1=RID signal 2=RID signal and Temperature
	Time-Const=2000	[Value]	Time constant
	SignalMode=	[Value]	Signal mode, 0=+, 1=-
	AnswerTimeOut=	[Value]	Do not change
	ConnectionTimeOut=	[Value]	Do not change
	Temperature=0 /30-55	[Value]	0=Off 30-55=Temperature is set after start
	TempZone=1	[1-8]	1= [Temperature] FunctionName1=... ... 2= [Temperature] FunctionName2=... ...
[KnauerDAD61L]	Enabled=1	[0/1]	DAD is disabled/enabled
	IP=	[IP]	IP address
	Port =	[Port]	Portnumber
	Integration=100	[Value]	Preset value for DAD integration time.
	OptimiseIT=1	[0/1]	Enable/disable integration time optimisation

	Entries		Explanation
[DAD]	Enabled=0	[0/1]	Enables the DAD program functions.
	Diodes=1024/256	[Value]	Number of diodes in the diode array. 256=DAD 2.1L 1024=DAD 6.1L
	ScanStart=200	[Value]	Spectrum start of DAD.
	ScanEnd=600	[Value]	Spectrum end of DAD.
	Slice-Width=100	[Value]	Preset value for DAD slicewidth.
	IntegrationTime=100	[Value]	Preset value for DAD integration time.
	Integration-Bandwidth=1	[Value]	Preset value for DAD integration bandwidth.
	AutomaticReference=1	[0/1]	Automatic reference spectrum after starting a time control file.
	Lambert-Beer=1	[Value]	This value is required. Do not change!
[KnauerIFU21]	Enabled=1	[0/1]	IFU is disabled/enabled
	IP=	[IP]	IP address (only for IFU 2.1 LAN)
	Port=	[Port]	Portnumber
	DataRate=2	[Value]	Data rate of the IFU
	Channels=1	[Value]	Number of channels
[KnauerCM21S]	Enabled=1	[0/1]	CM is disabled/enabled
	IP=	[IP]	IP-address
	Port=	[Port]	Portnumber
	DataRate=2	[Value]	Datarate of CM 2.1S

	Entries		Explanation
	Chan-nels=1/2/3	[Value]	Number of channels 1=only conductivity 2=Conductivity and pH 3=Conductivity, pH and temperature
[Smartline2600]	Integra-tion=20	[Value]	Integration time of KNAUER Smartline DAD.
[Calibration]	p0=1.900000 000E+002	[Value]	Calibration factor 0 of the DAD.
	p1=2.000000 000E+000	[Value]	Calibration factor 1 of the DAD.
	p2=0.000000 000E+00	[Value]	Calibration factor 2 of the DAD.
	p3=0.000000 000E+000	[Value]	Calibration factor 3 of the DAD.
	p4=0.000000 000E+000	[Value]	Calibration factor 4 of the DAD.
[Eventbox]	Pulse-length=0.5	[0.1- ...]	Pulse length of the event box out-puts in seconds.
[SignalInverting]	EventBox=0 Gameport=0	[1-12] [1-4]	Listed EventBox or Gameport inputs will be inverted.
[Temperature]	FunctionNa-me1=...	[Text]	User defined name of the function „Temperature 1“.
	FunctionNa-me2=...	[Text]	User defined name of the function „Temperature 2“.
	Stirrer-Speed=150	[Value]	Heater stirrer speed.
[MultiSystem]	Enabled=0	[0/1]	To run the software several times on one computer. This is not supported with PurityChrom.
	DataChan-nel1=1	[1-8]	Number of the data channel that is allocated to the first system in a multiple system.

	Entries	Explanation
	DataChannel2=2 [1-8]	Number of the data channel that is allocated to the second system in a multiple system.
	DataChannel3=3 [1-8]	Number of the data channel that is allocated to the Third system in a multiple system.
	DataChannel4=4 [1-8]	Number of the data channel that is allocated to the fourth system in a multiple system.
[IntegrationPresets]	IntegrateInhibit=0 [0/ ...]	Data channels that are not to be automatically integrated, are to be entered separated by commas.
	MaxBaselineLevel=250 [...]	Preset values for integration outside peak windows (see chapter 13 on page 74).
	FilterFactor=5 [5-15]	
	SlopeSensitivity=500 [...]	
	AreaDelay=0 [0/1]	Enables an input field in the threshold programming where a delay time for crossing execution can be entered.
	TailingFactor=0 [0/1]	Instead of Assymetry the tailing factor will be calculated.
[SolventSupply]	AnalogA=0 [1-8]	Number of the channel that records the level signal of solvent A.
	AnalogB=0 [1-8]	Number of the channel that records the level signal of solvent B.
	AnalogC=0 [1-8]	Number of the channel that records the level signal of solvent C.
	AnalogD=0 [1-8]	Number of the channel that records the level signal of solvent D.
	AnalogWaste=0 [1-8]	Number of the channel that records the level signal of waste.
	SoundfileWaste=*.wav [*.wav]	Sound wave file that plays automatically when the waste level is upper maximum.
	SoundfileSolvents=*.wav [*.wav]	Sound wave file that plays automatically when a solvent level is under minimum.

	Entries	Explanation	
[WasteManagement]	ValveNo=1	[1- ...]	Number of the waste/fraction valve when using waste management.
	BypassValve=0	[1- ...]	Number of the bypass valve when using waste management.
	Volume=10000	[...]	Volumes of waste containers when using waste management.
	ErrorInput=0	[1- ...]	Number of the EventBox input for a error signal.
	Soundfile=Fehler.wav	[*.wav]	Sound wave file that plays automatically when an error occurs.
[LeakageInput]	LeakageInput=0	[1-12]	Event box input for leakage sensors. 3 = Leakage Sensor of major pump if P 6.1L or P 2.1L 7= Leakage Sensor of minor pump if P 6.1L or P 2.1L
	Leakage-Countdown=120	[0- ...]	Countdown in seconds until the system is stopped following the detection of a leak.
	Soundfile=Fehler.wav	[*.wav]	Sound wave file that plays automatically when a leak has been detected.
	WindowsShutdown=0	[0/1]	Enable/disable windows shutdown
	EluentValveA=2	[1- ...]	Valve number for sealing off eluent Solvent A.
	EluentValveB=3	[1- ...]	Valve number for sealing off eluent Solvent B.
	EluentValveC=4	[1- ...]	Valve number for sealing off eluent Solvent C.
[LeakageKnauer ASM]	EluentValveD=5	[1- ...]	Valve number for sealing off eluent Solvent D.
	Enabled=0	[0/1]	Leakage sensor of an ASM can be activated.
	IP=	[IP]	IP-adress of ASM

	Entries		Explanation
	Port=	[Port]	Portnumber for the entire ASM.
<p>Note: Only one ASM Leaksensor can be incorporated, please make sure that it is the lowest device in the AZURA tower.</p>			
[KnauerASM21L]	Enabled=1	[0/1]	Enable/disable error management of ASM
	IP=	[IP]	IP-adress of ASM
	Port=	[Port]	Portnumber of the ASM
[DemoMode]	Chromatogram=*.rfp	[*.rfp]	Result file for a simulated chromatogram signal in demo mode.
[Visualisation]	ValvePartitioning=0	[1- ...]	Number of the fraction valve that will be partitioned in horizontal segments. Doubleclicking on a segment switches the valve to the matching position number instead of the next position.
[TandemValve]	Index=0	[1- ...]	Number of the tandem valve
	SecondWinsockPort=1	[1- ...]	Number of the Winsock-Port of the 2nd valve
	PositionRequest=0	[0/1]	Before starting the time control file, the user will be asked for a valve position.
[Recycling]	Solvent=A	[A/B/C/D]	Solvent used for recycling
	ValveIndex=0	[1- ...]	Number of recycling valve
	ValvePosition=2	[0/1]	Recycling position
[SedexLC]	Enabled=0	[0/1]	SedexLC is disabled/enabled
	Port=2	[Value]	Port number

	Entries	Explanation
	TempZone=1 [Value]	TempZone=1 [1-8] 1= [Temperature] FunctionName1=... ... 2= [Temperature] FunctionName2=... ...
[PressureSensor]	Enabled=0 [0/1]	Activates external pressure sensor via LAN.
	IP=192.168.1.126 [IP]	IP address of first external pressure sensor
	Port=10001 [Value]	Portnumber of first external pressure sensor
	IP2=192.168.1.127 [IP]	IP address of second external pressure sensor
	Port2=10001 [Value]	Portnumber of second external pressure sensor
	Channels=0 [Value]	Amount of channels of external pressure sensors
[Mimmert]	Enabled= [0/1]	The UN 55 oven is disabled/ enabled.
	IP= [IP]	IP-address
	Tmax= [Value]	Max. temperature
[Microsaic]	Enabled= [0/1]	MS is disabled/enabled.
	IP= [IP]	IP-address
	Factor= [Value]	Factor which is multiplied with the number of counts
	StopScan= [0/1]	At end of time control file MS scan is stop-ped or continued
	Logfile= [0/1]	A constant log file for the 4000 MiD will be created.

23.2 PurityChromfile types

- *.tcf PurityChrom-Time Control File.
- *.acf PurityChrom-Autosampler Control File.
- *.rfp PurityChrom-Result File. Includes the result data of a run.
- *.dad PurityChrom-DAD-File. Includes the spectra of a DAD run.
- *.rck PurityChrom-Fraction Collector Rack File. Includes the geometric data of a fraction collector rack.
- *.vis PurityChrom-Visualisation File. Includes the data of a system visualisation.
- *.cfg PurityChrom-Configuration File. Includes the data of the program configuration.

23.3 Combination of autosampler tray types

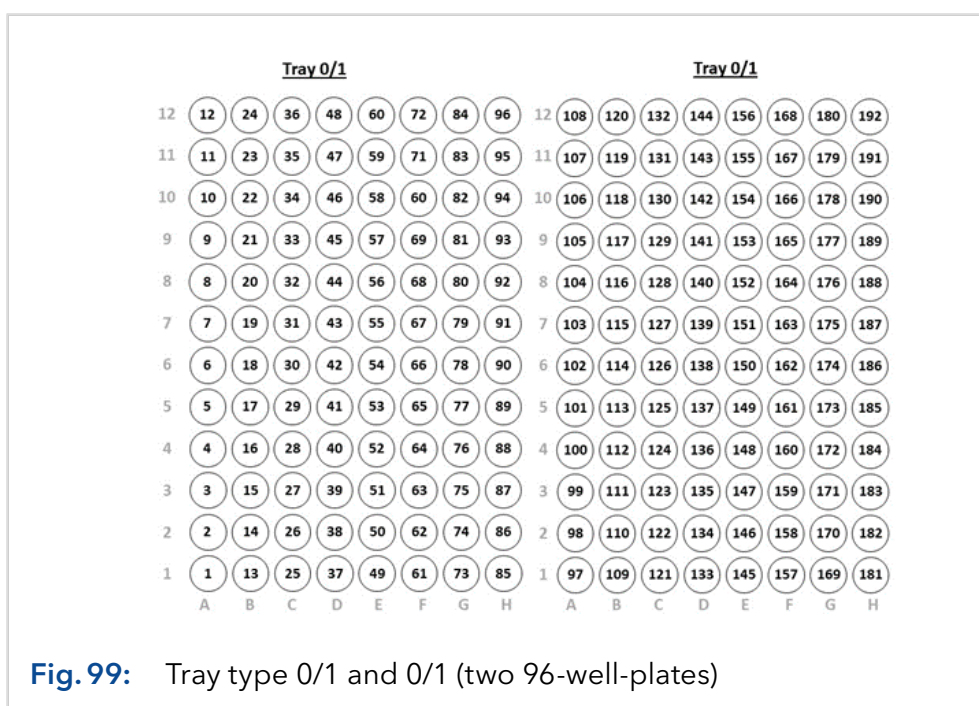
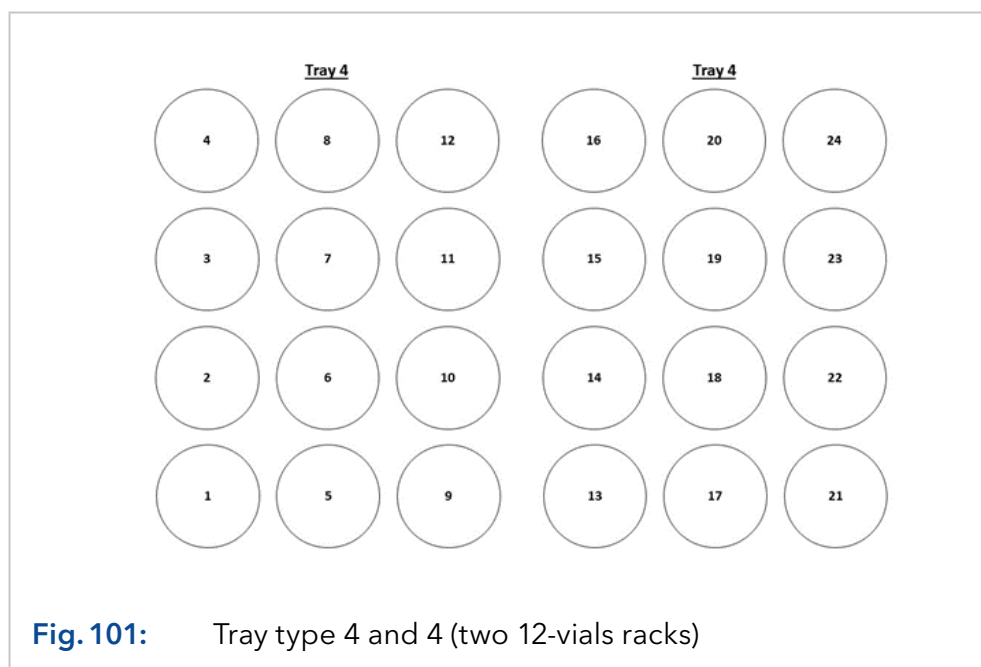
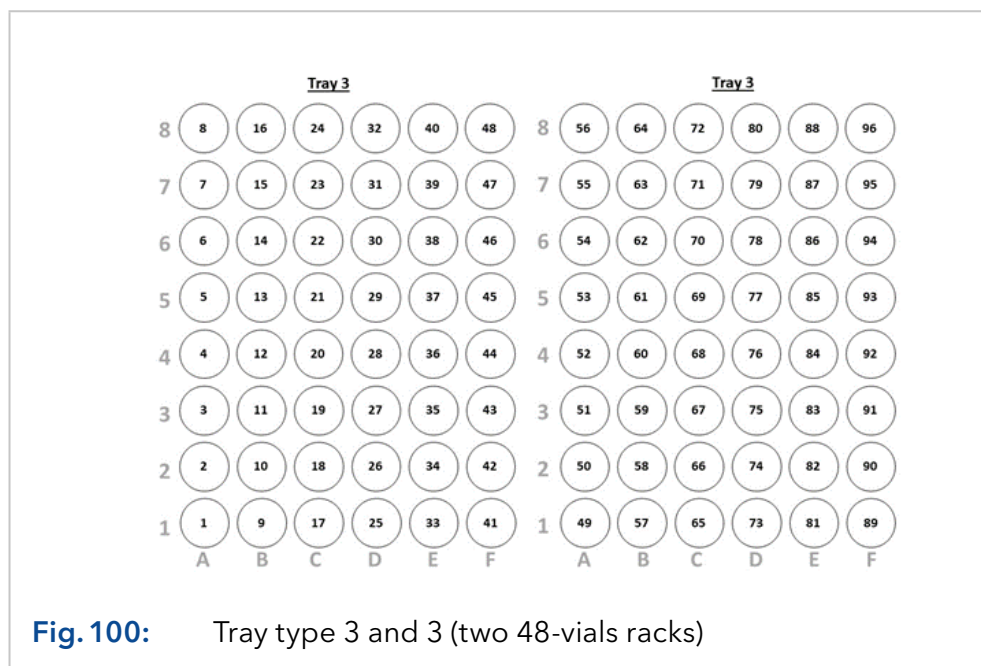
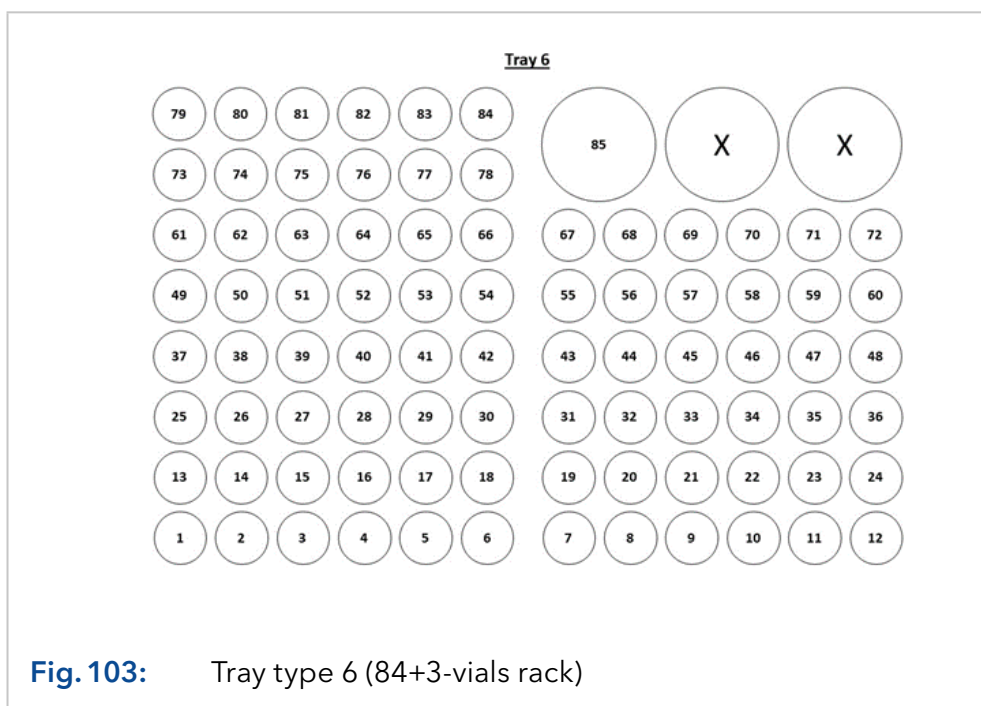
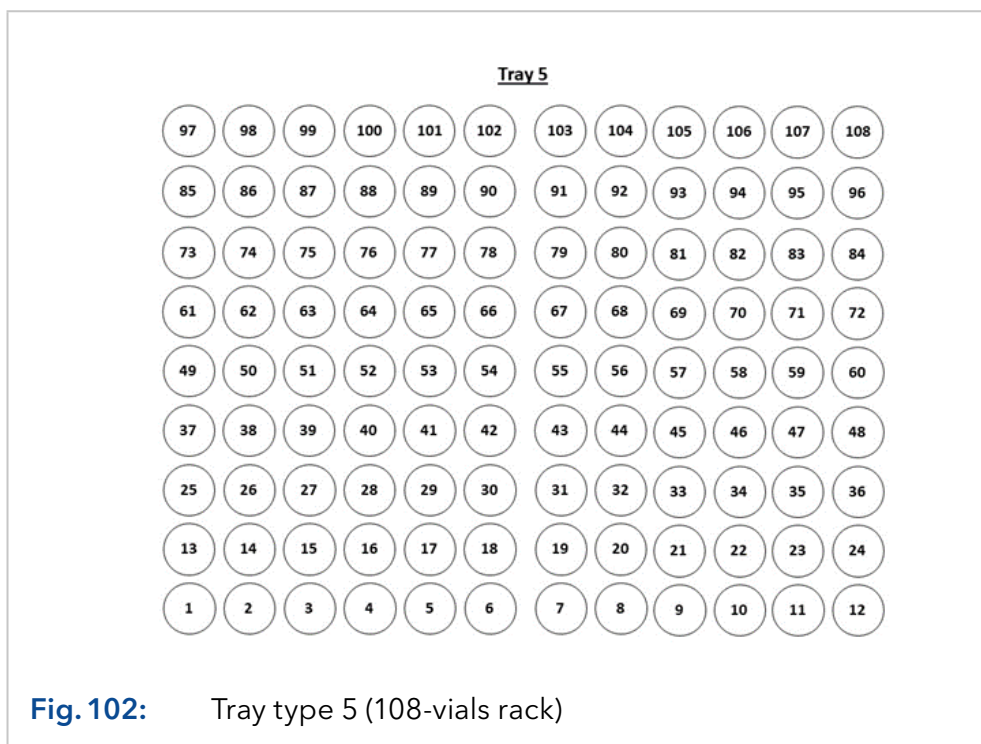
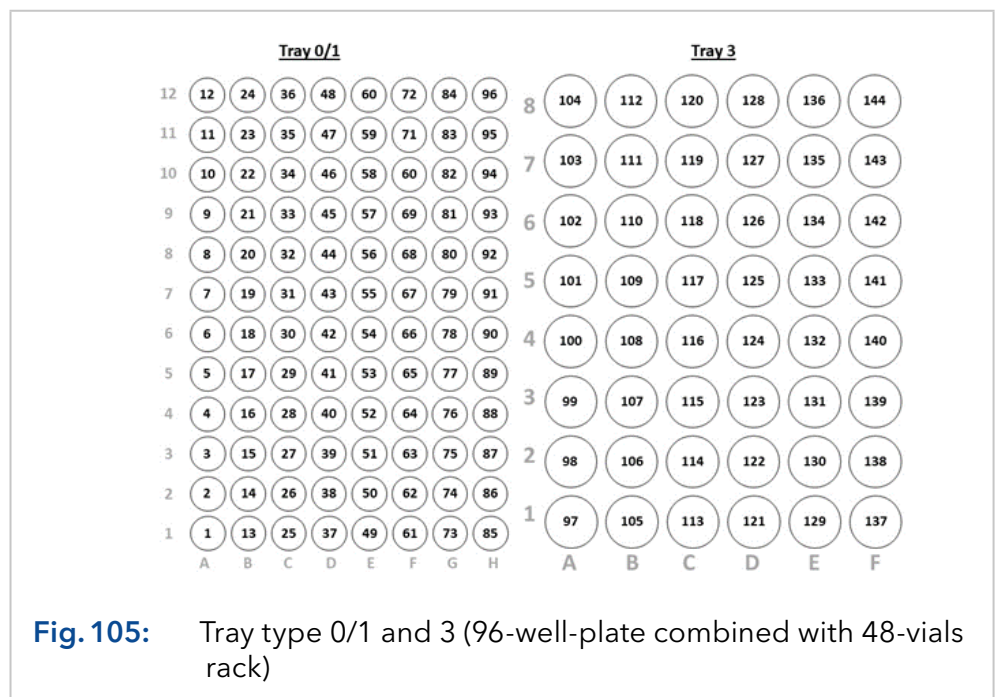
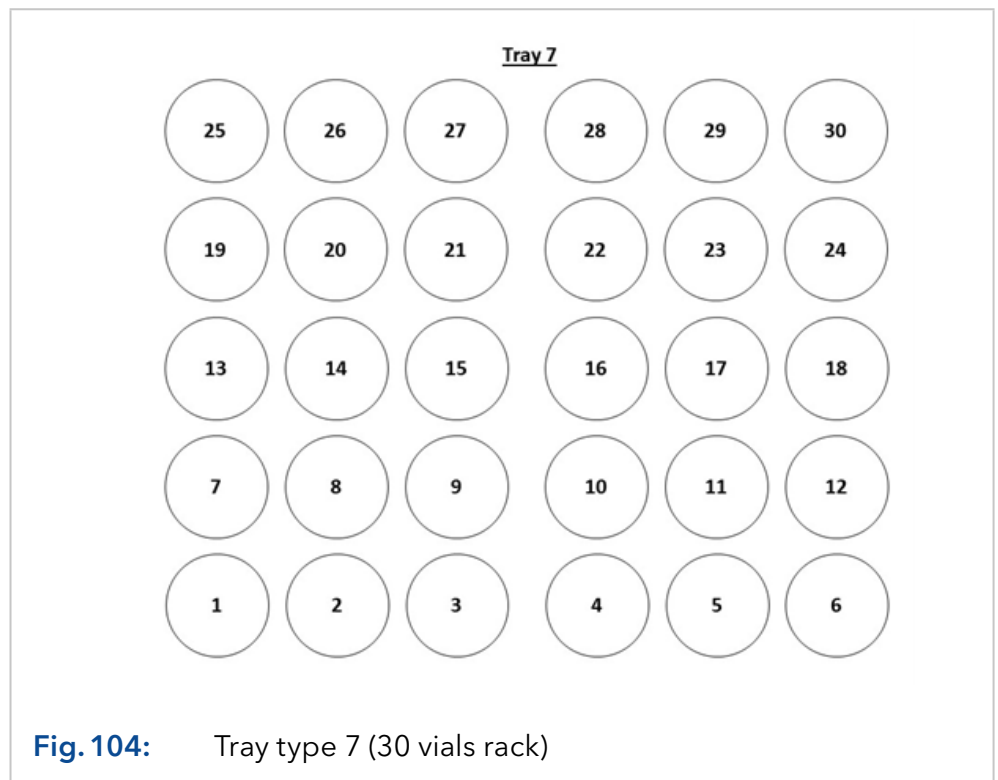
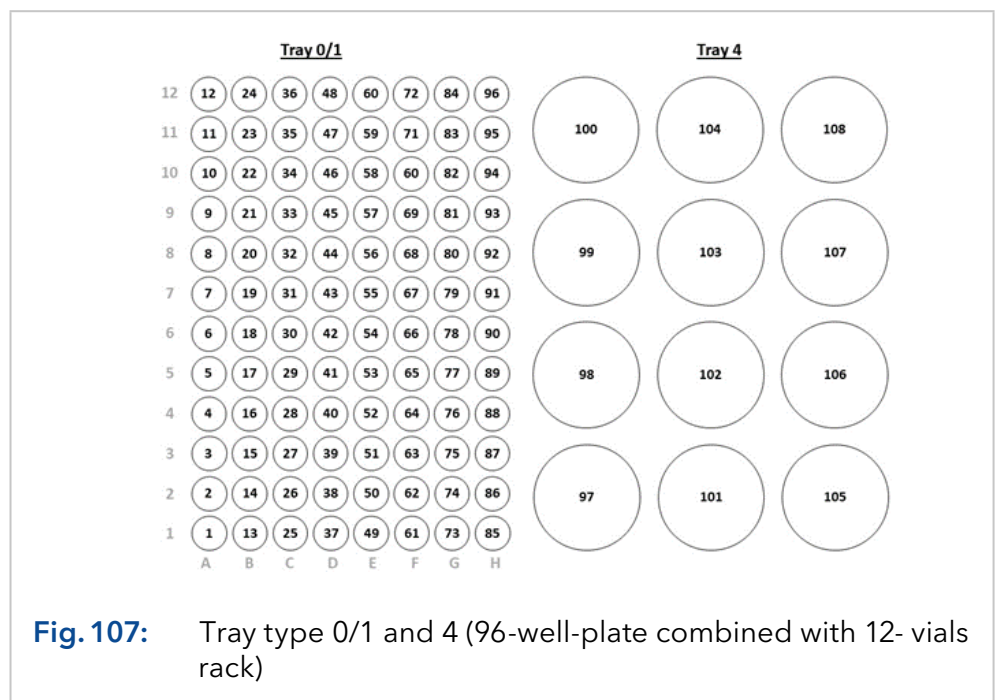
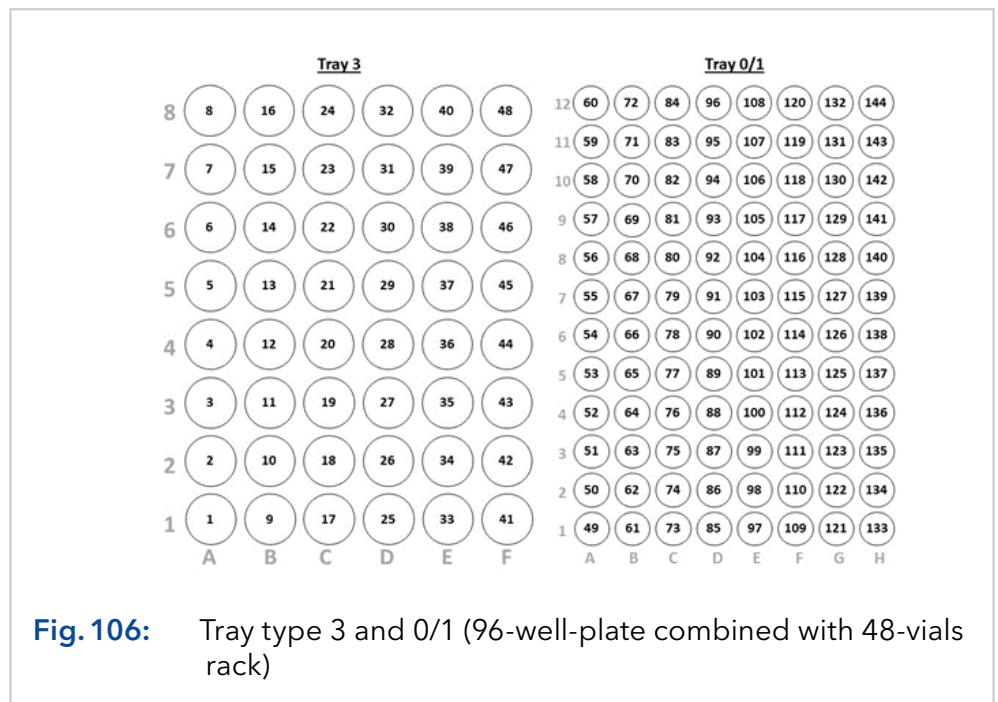

Fig. 99: Tray type 0/1 and 0/1 (two 96-well-plates)









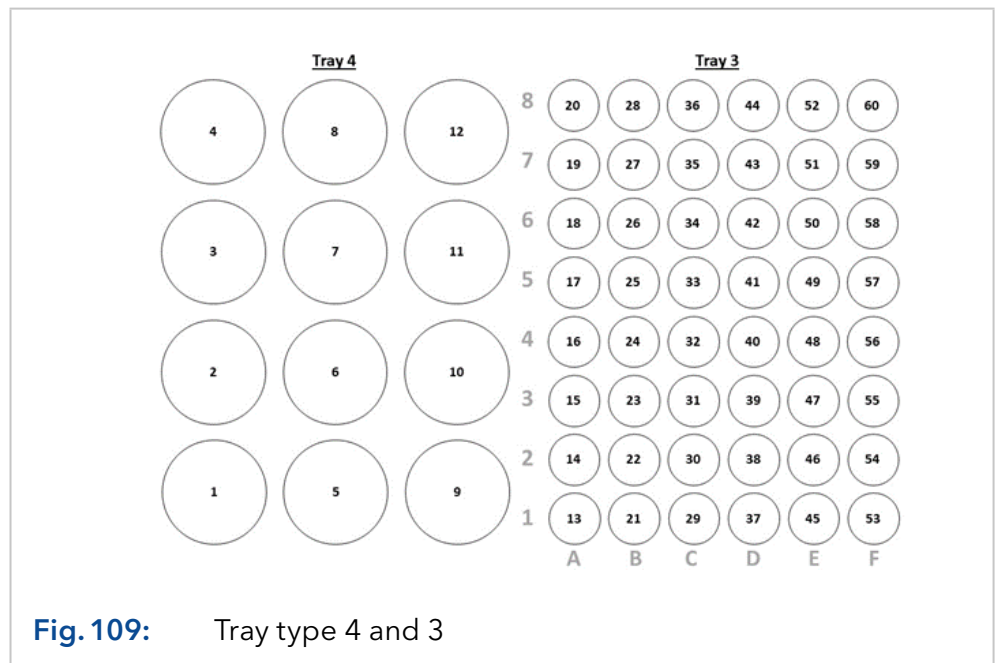
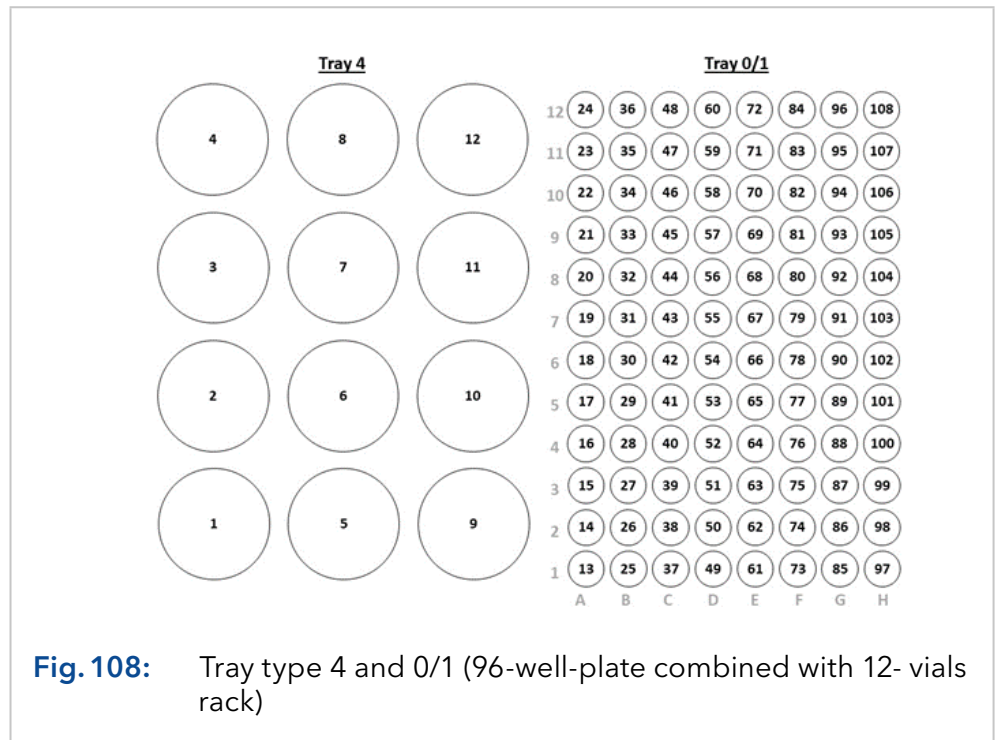

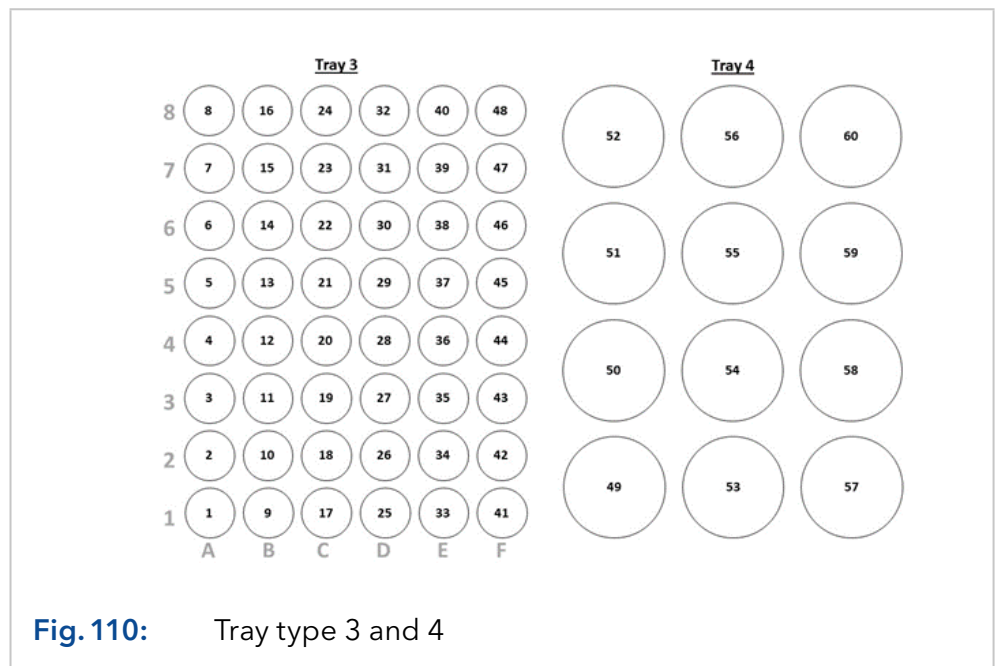

Science Together



Latest KNAUER instructions online:
www.knauer.net/library

KNAUER
Wissenschaftliche Geräte GmbH
Hegauer Weg 38
14163 Berlin

Phone: +49 30 809727-0
Fax: +49 30 8015010
E-Mail: info@knauer.net
Internet: www.knauer.net